

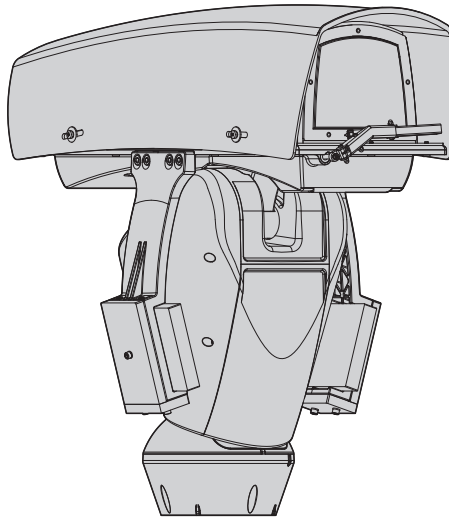

ULISSE MAXI

PTZ unit for dynamic monitoring of large outdoor areas



EN English - Instructions manual

IT Italiano - Manuale di istruzioni

FR Français - Manuel d'instructions

DE Deutsch - Bedienungsanleitung

RU Русский - Руководство по эксплуатации



ULISSE MAXI

PTZ unit for dynamic monitoring of large outdoor areas

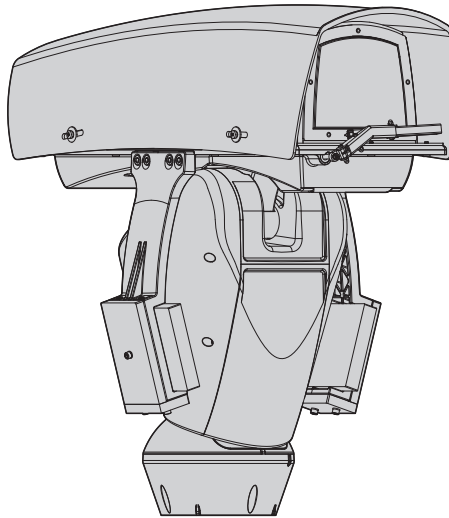

Contents

1 About this manual	7
1.1 Typographical conventions.....	7
2 Notes on copyright and information on trademarks.....	7
3 Safety rules.....	7
4 Identification.....	10
4.1 Product description and type designation.....	10
4.2 Product markings	10
4.2.1 Checking the markings	10
5 Versions	11
5.1 LED illuminators	11
5.2 Germanium window.....	11
6 Preparing the product for use	12
6.1 Safety precautions before use.....	12
6.2 Unpacking.....	12
6.3 Contents.....	12
6.4 Safely disposing of packaging material.....	12
6.5 Preparatory work before installation	13
6.5.1 Attaching the bracket	13
6.5.2 Cables management	13
7 Assembly	14
7.1 Fixing the sunshield.....	14
7.2 How to open the housing.....	14
7.3 Assembling the camera and motorised lenses.....	14
7.3.1 Cameras features	14
7.3.2 Fastening the lens and the camera to the internal slide	15
7.3.3 Positioning of the H-20 spacer on the inner slide.....	16
7.3.4 Internal slide.....	16
7.4 Housing board description	17
7.4.1 Connection of the camera and motorised lens	17
7.4.2 Adjustment of the supply voltage of the lens motors	18
8 Installation	19
8.1 Connecting the cables to the base.....	19
8.2 Fixing the base to the support.....	20
8.3 Connector board description.....	21
8.4 Connection of the power supply line.....	22
8.4.1 24Vac power line connection.....	23
8.4.2 120Vac and 230Vac power line connection	23
8.5 Signal cable connection.....	24
8.5.1 Video cable connection.....	24
8.5.2 Telemetry lines connections	25
8.5.3 Connection of the alarm inputs, of the twilight switch and of the relays.....	26

8.6	Fixing the upper body.....	27
8.7	Counterweights installation	27
8.8	LED illuminators installation.....	28
8.8.1	Counterweight removal.....	28
8.8.2	Fitting the illuminator on the bracket.....	28
8.9	Connection of the LED illuminators.....	29
8.10	Connection for cameras and LED illuminators synchronisation.....	30
8.11	Desiccant bag	30
8.12	LED illuminator activation and adjustment instructions.....	30
8.12.1	Description of the LED illuminator	30
8.12.2	Activation of the LED illuminator via an external dusk switch.....	31
8.12.3	Activation of the LED illuminator via the integrated dusk sensor.....	31
8.12.4	LED illuminator switching on threshold adjustment.....	32
8.12.5	LED illuminator power adjustment	32
8.13	Fastening of the wiper blade	33
8.14	Hardware configuration.....	34
8.14.1	Opening the configuration door	34
8.14.2	DIP1 configuration.....	34
8.14.3	DIP2 configuration.....	34
8.14.4	DIP3 configuration.....	35
8.14.4.1	Address configuration	35
8.14.4.2	Setting of the serial communication lines	35
8.14.5	DIP4 configuration.....	35
8.14.6	Installation examples.....	36
8.14.6.1	RS-485 RX line.....	36
8.14.6.2	RS-422 line (RS-485-1 RX e RS-485-2 TX).....	36
8.14.6.3	Line RS-485-1 reception, line RS-485-2 repetition.....	36
8.14.6.4	Two-way RS-485 TX/RX line	36
9	Switching on	37
9.1	First start-up.....	37
9.2	Checks list.....	37
10	Configuration.....	38
10.1	OSM interface (On Screen Menu)	38
10.1.1	Using the OSM	38
10.1.1.1	How to use the joystick.....	38
10.1.1.2	How to move around the menus.....	39
10.1.1.3	How to modify the parameters	39
10.1.1.4	How to change the numeric fields.....	40
10.1.1.5	How to change text.....	40
10.1.2	Configuration via OSM	42
10.1.3	Main Menu.....	42
10.1.4	Language Selection Menu.....	42
10.1.5	ZFI Parameter Menu.....	42
10.1.5.1	Zone Titling Menu.....	43
10.1.5.2	Zone Masking Menu	44
10.1.6	Housing Serial Port Menu	45
10.1.7	Polarity Menu	45
10.1.8	Movement Menu.....	46
10.1.8.1	Manual Control Menu.....	46

10.1.8.2 Manual Control Menu (Limits).....	47
10.1.8.3 Preset Menu	47
10.1.8.4 Preset Menu (Edit Preset)	47
10.1.8.5 Preset Menu (Utility Preset)	48
10.1.8.6 Patrol Menu	48
10.1.8.7 Autopan Menu	48
10.1.8.8 Motion Recall Menu	49
10.1.9 Display Menu	49
10.1.10 Digital I/O-Options Menu	49
10.1.10.1 Alarms Menu	50
10.1.10.2 Communication menu.....	50
10.1.10.3 Washer Menu.....	51
10.1.11 Default Menu	51
10.1.12 Info Menu	51
11 Accessories.....	52
11.1 Washer	52
11.1.1 Washing system connection	52
11.2 Wall mount bracket	53
11.3 Parapet bracket.....	53
11.4 Power supply with illuminator control	53
12 Instructions for normal operation	54
12.1 Visualizing the state of the pan & tilt.....	54
12.2 Saving a Preset	54
12.3 Restore a Preset position (Scan).....	54
12.4 Recalling the Home position.....	54
12.5 Patrol enabling.....	54
12.6 Autopan enabling	55
12.7 Enabling the wiper (Wiper).....	55
12.8 Enabling the washer (Washer).....	55
12.9 Enabling the LED illuminator	55
12.10 Unit Reboot.....	55
12.11 Special controls	56
12.12 Special configurations.....	57
13 Maintenance	58
13.1 Fuses replacement	58
14 Cleaning	58
14.1 Window and plastic cover cleaning.....	58
14.2 Cleaning the germanium window	58
15 Disposal of waste materials.....	58
16 Troubleshooting	59
17 Technical data	61
17.1 General	61
17.2 Mechanical.....	61
17.3 Housing's window.....	61
17.4 Electrical	61

17.5 Video	62
17.6 Communications	62
17.7 Protocols.....	62
17.8 I/O interface.....	62
17.9 Lenses.....	62
17.10 Environment.....	62
17.11 Certifications	62
18 Technical drawings	63
A Appendix - Address table	66

1 About this manual

Read all the documentation supplied carefully before installing and using this unit. Keep the manual in a convenient place for future reference.

1.1 Typographical conventions



DANGER!
High level hazard.
Risk of electric shock. Disconnect the power supply before proceeding with any operation, unless indicated otherwise.



DANGER!
Hot surface.
Avoid contact. Surfaces are hot and may cause personal injury if touched.



DANGER!
Mechanical hazard.
Risk of crushing or shearing.



CAUTION!
Medium level hazard.
This operation is very important for the system to function properly. Please read the procedure described very carefully and carry it out as instructed.



INFO
Description of system specifications.
We recommend reading this part carefully in order to understand the subsequent stages.

2 Notes on copyright and information on trademarks

The quoted names of products or companies are trademarks or registered trademarks.

3 Safety rules



CAUTION! The electrical system to which the unit is connected must be equipped with a 20A max automatic bipolar circuit breaker. This circuit breaker must be of the Listed type. The minimum distance between the circuit breaker contacts must be 3mm (0.1in). The circuit breaker must be provided with protection against the fault current towards the ground (differential) and the overcurrent (magnetothermal).



CAUTION! Hazardous moving parts. Keep fingers and other body parts away.



CAUTION! Device installation and maintaining must be performed by specialist technical staff only.



CAUTION! For continued protection against risk of fire, replace only with same type and rating of fuse. Fuses must be replaced only by service personnel.



CAUTION! TNV-1 installation type. The installation is type TNV-1, do not connect it to SELV circuits.



CAUTION! In order to reduce the risk of fire, only use UL Listed or CSA certified cables with sections greater than or equal to 0.14mm² (26AWG).

- The manufacturer declines all responsibility for any damage caused by an improper use of the appliances mentioned in this manual. Furthermore, the manufacturer reserves the right to modify its contents without any prior notice. The documentation contained in this manual has been collected with great care. The manufacturer, however, cannot take any liability for its use. The same thing can be said for any person or company involved in the creation and production of this manual.

- Before starting any operation, make sure the power supply is disconnected.
- Be careful not to use cables that seem worn or old.
- Never, under any circumstances, make any changes or connections that are not shown in this handbook. Improper use of the appliance can cause serious hazards, risking the safety of personnel and of the installation.
- Use only original spare parts. Non-original spare parts could cause fire, electrical discharge or other hazards.
- Before proceeding with installation, check the supplied material to make sure it corresponds to the order specification by examining the identification labels (4.2 Product markings, page 10).
- Installation category (also called Overvoltage Category) specifies the level of mains voltage surges that the equipment will be subjected to. The category depends upon the location of the equipment, and on any external surge protection provided. Equipment in an industrial environment, directly connected to major feeders/short branch circuits, is subjected to Installation Category III. If this is the case, a reduction to Installation Category II is required. This can be achieved by use of an insulating transformer with an earthed screen between primary and secondary, or by fitting UL listed Surge Protective Devices (SPDs) from live to neutral and from neutral to earth. Listed SPDs shall be designed for repeated limiting of transient voltage surges, suitable rated for operating voltage and designated as follows: Type 2 (Permanently connected SPDs intended for installation on the load side of the service equipment overcurrent device); Nominal Discharge Current (I_n) 20kA min. For example: FERRAZ SHAWMUT, STT2240SPG-CN, STT2BL240SPG-CN rated 120Vac/240Vac, ($I_n=20kA$). Maximum distance between installation and reduction is 5m.
- This device was designed to be permanently secured and connected on a building or on a suitable structure. The device must be permanently secured and connected before any operation.
- A power disconnect device must be included in the electrical installation, and it must be very quickly recognizable and operated if needed.
- The separate protective earthing terminal provided on this product shall be permanently connected to earth.
- Connect the device to a power source corresponding to the indications given on the marking label. Before proceeding with installation make sure that the power line is properly isolated. The supply voltage should never exceed the limit ($\pm 10\%$).
- Power supply must be provided with a SELV type, 24Vac, 8A isolated source derived from a double isolation UL Listed transformer specially protected in output.
- The device should be mounted so that it is accessible only to the technician/installer because the moving parts constitute a residual risk of injury caused by movement of said parts.
- Attach the Dangerous Moving Parts label near the device. (Fig. 4, page 12).
- Do not use the appliance in the presence of inflammable substances.
- To connect the power supply line use the appropriate junction-box (UPTJBUL). For further information, refer to the product use and installation manual.

- Do not allow children or unauthorised people to use the appliance.
- Only skilled personnel should carry out maintenance on the device. When carrying out maintenance, the operator is exposed to the risk of electrocution and other hazards.
- Use only the accessories indicated by the manufacturer. Any change that is not expressly approved by the manufacturer will invalidate the guarantee.
- Connect the coaxial cable to earth.
- Before connecting all the cables make sure the device is properly connected to the earth circuit.
- If the device has to be removed from the installation, always disconnect the earth cable last.
- Take all necessary precautions to prevent the apparatus from being damaged by electrostatic discharge.
- The unit has been made for connection using a 3-pole cable. To make a correct connection to the earth circuit, follow the instructions in this handbook.
- Handle the unit with great care, high mechanical stress could damage it.
- Make especially sure that the power supply line is insulated at a sufficient distance from all the other cables, including lightning protection devices.
- If it is necessary to transport the device, this should be done with great care. Abrupt stops, bumps and violent impact could damage the unit or injure the user.

4 Identification

4.1 Product description and type designation

ULISSE MAXI is a robust and efficient PTZ camera unit designed to ensure dynamic and non-stop surveillance of large outdoor areas and withstand harsh weather conditions.

This model can contain and manage the largest motorised lenses on the market, with a total weight of up to almost 8 kilos.

This way a single unit can provide a 360° coverage of the area to be monitored.

To ensure detailed images even during the night hours, versions are available with LED illuminators, with infrared light or white light.

The sturdy mechanical structure and the powerful motors of this PTZ are designed to guarantee maximum resistance to high operating stress, vibrations and temperatures between -10°C to +60°C.

The unit is equipped with optical sensors which ensure the accurate control of the position in any condition of use.

The unit is equipped with a wiper for removing rain and dust from the front glass; there is a wide selection of jerry cans with washer pump, different capacities and heads.

Models are available for vision with a thermal camera.

4.2 Product markings

i Pan & tilt devices have a label complying with CE markings.

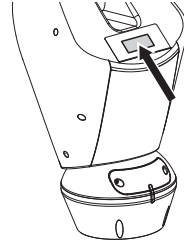

Fig. 1

The label shows:

- Model identification code (Extended 3/9 bar code).
- Power supply (Volt).
- Frequency (Hertz).
- Current consumption (Amps).
- Weatherproof standard (IP).
- Serial number.

4.2.1 Checking the markings

Before proceeding further with installation, make sure the material supplied corresponds to the order specification by examining the marking labels.

Never, under any circumstances, make any changes or connections that are not shown in this handbook. Improper use of the appliance can cause serious hazards, risking the safety of personnel and of the installation.

5 Versions

5.1 LED illuminators



The version with LED illuminators can only be powered at 24Vac.

The pan & tilt can be fitted with bracket for 2 VIDEOTEC LED illuminators for night surveillance (illuminators not included).

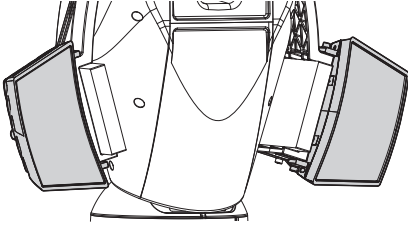

Fig. 2



For further information refer to the relative chapter (8.8 LED illuminators installation, page 28).

5.2 Germanium window

The version with germanium window has been developed for applications with thermal cameras.

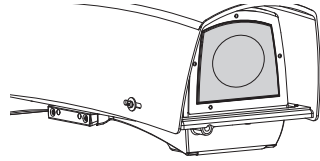



Fig. 3

6 Preparing the product for use

 **Any change that is not expressly approved by the manufacturer will invalidate the guarantee.**

 **The unit must not be dismantled or tampered with. The only exceptions are those concerning the assembly and maintenance operations stipulated in this manual.**

6.1 Safety precautions before use

 **The appliance includes moving parts. Make sure that the unit is positioned where it is inaccessible under normal operating conditions. Attach the warning label supplied with the appliance, placing it near the unit so that it can be seen easily.**



Fig. 4

6.2 Unpacking

When the product is delivered, make sure that the package is intact and that there are no signs that it has been dropped or scratched.

If there are obvious signs of damage, contact the supplier immediately.

Keep the packaging in case you need to send the product for repairs.

 **Unpack the sunshield of the device, taking care not to damage the housing.**

6.3 Contents

Check the contents to make sure they correspond with the list of materials as below:

- Positioning unit
- Power supply base
- Accessories package:
 - Serial adapter
 - Serial extension cable
 - Allen wrenches
 - Spacers
 - Spacers (not available in the version with integrated camera)
 - Label
 - Ties
 - Silicon sheath
 - Reduction gaskets for cable glands
 - Instructions manual
 - Attachment plate for desiccant bag
 - Desiccant bag
 - Bolts and screws
- Counterweights package:
 - Bracket for attachment of LED illuminators (available in the versions with LED illuminators)
 - Counterweights
 - Counterweights brackets
- Sunshield

6.4 Safely disposing of packaging material

The packaging material can all be recycled. The installer technician will be responsible for separating the material for disposal, and in any case for compliance with the legislation in force where the device is to be used.

When returning a faulty product we recommend using the original packaging for shipping.

6.5 Preparatory work before installation

6.5.1 Attaching the bracket

! For installations subject to vibrations, only use the parapet bracket.

Different types of supports are available (11 Accessories, page 52). Choose a suitable bracket for the installation and follow all the instructions in the suggested chapter.

! Take special care when attaching and fastening down the apparatus. The clamping system must be able to support at least 4 times the weight of the entire equipment, including P&T, lenses and camera.

! The device should be assembled vertically. Any other position could impair the performance of the appliance.

! Do not attach the device upside down.

6.5.2 Cables management

! The connection cables should not be accessible from the outside. It is necessary to fasten the cables securely to the support in order to prevent excessive weight pulling them out accidentally.

! You must use cables suited to the type of installation.

Insert the cables into the support so that they protrude by about 50cm.

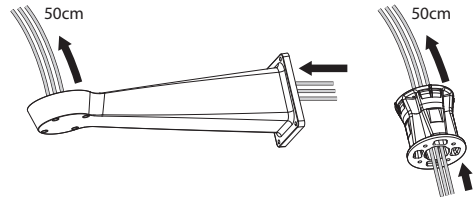

Fig. 5

7 Assembly

7.1 Fixing the sunshield

Mount the sunshield to the housing with the 4 screws and 4 washers couples provided.

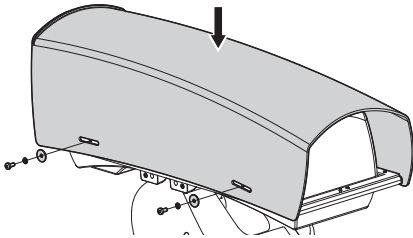

Fig. 6

7.2 How to open the housing

Loosen the leak-proof screws placed on the sides and lift the upper part of the housing.

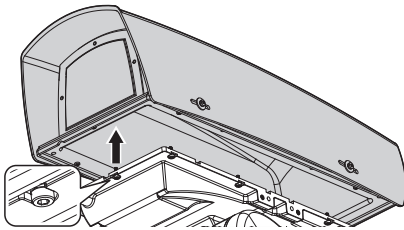

Fig. 7

i After installation and wiring, close the product again.

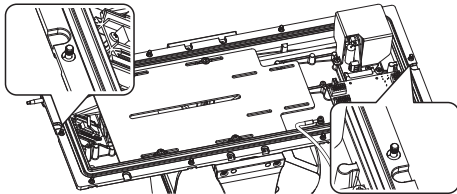

Fig. 8

i First of all tighten the two central screws as shown in figure.

7.3 Assembling the camera and motorised lenses

The customer has to take care of assembling the camera and lenses.

7.3.1 Cameras features

! The correct operation of the equipment, within the temperature range indicated, is guaranteed only if you use camera and lens with temperature limits equal to at least -10°C and $+60^{\circ}\text{C}$.

- The power supply voltage of the camera must be 12Vdc.
- The maximum current absorbed by the camera must be lower than the value indicated below: 800mA.
- The camera output video signal must be of the composite type with amplitude 1Vpp (negative sync).

7.3.2 Fastening the lens and the camera to the internal slide

! It is necessary to insulate the camera body from the attachment slide in order to prevent interference with the video signal.

! Maximum overall weight allowed for camera and lens must not exceed 7.6kg (16.8lb).

Connect the camera (02) to the lens (01).

Fasten the L-shaped small aluminium bracket (03) to the camera by means of the nylon washer (04) and the 1/4" screw (05).

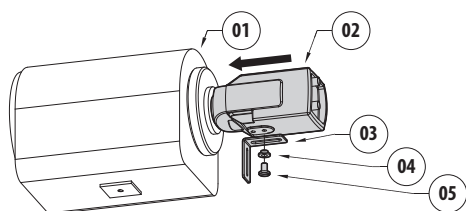

Fig. 9

Position the lens on the slide (02) interposing the plastic spacer (01). Fasten the whole assembly by means of the nylon washer (03) and the 1/4" screw (04).

If necessary, use the additional spacers to correctly position the camera and lens.

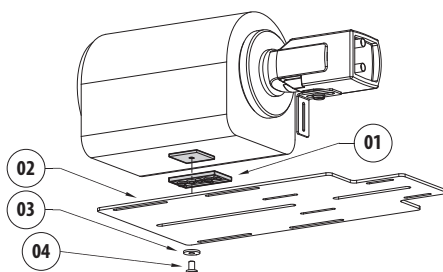

Fig. 10

Fasten the aluminium plate (01) on the slide by means of the screws and relative washers (02).

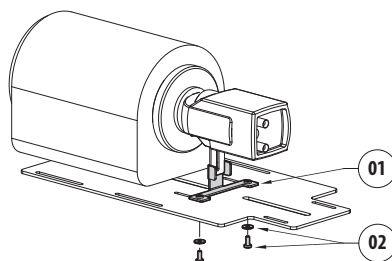

Fig. 11

Fix the L-bracket with the screw.

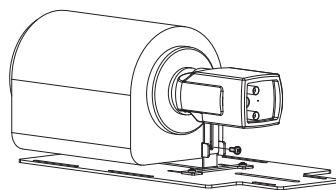

Fig. 12

7.3.3 Positioning of the H-20 spacer on the inner slide

It is possible to fasten the H-20 spacer (02) to the lens. Connect the camera and fasten the L-shaped bracket (Fig. 9, page 15). Interpose a plastic spacer (01) of the required thickness and fix it by means of washer and screw (03).

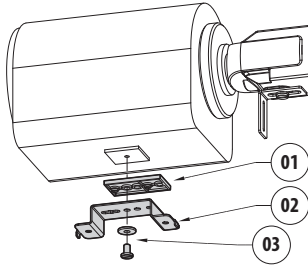

Fig. 13

Position the lens with the spacer on the inner slide (01) and fasten the spacer by means of the washers and screws (02) provided as standard.

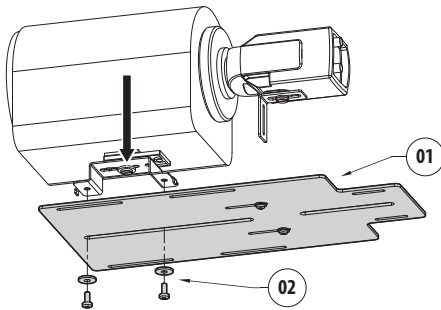

Fig. 14

Finish the installation as shown in the images (Fig. 11, page 15 e Fig. 12, page 15).

7.3.4 Internal slide

Shift the inner slide with lens and camera already fastened into the wanted position and secure it by means of the washers and screws provided.

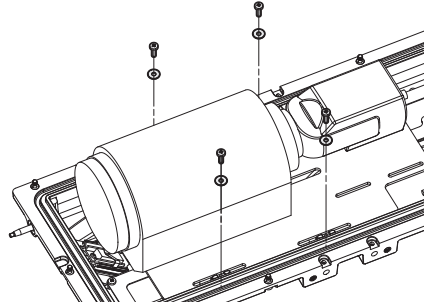

Fig. 15

7.4 Housing board description

BOARD DESCRIPTION	
Connector/Terminal	Function
CN1	BNC connector, video signal from the camera
CN2	Motorised lens motor control connector
CN3	Motorised lens potentiometer connector
CN6	Serial connector for controlling the camera
CN7	Camera power supply, dry contact for activating the Day/Night camera mode, additional lines
DIP1	Select the lens power supply voltage

Tab. 1

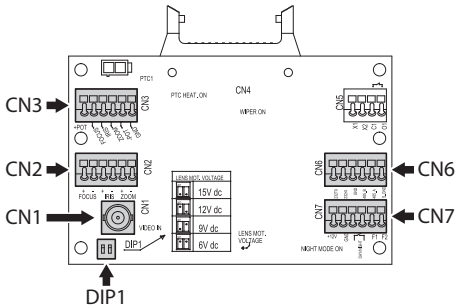

Fig. 16

7.4.1 Connection of the camera and motorised lens

⚠ All connections illustrated below should be made only and exclusively by expert installers who should comply with all the wiring and power supply specifications for the devices.

The electronics board is designed to control cameras with motorised lenses, which may or may not have potentiometers to control the position reached.

⚠ Before making the connections make sure that the voltages supplied by the board fall within the limits allowed for the apparatus.

CONNECTOR FOR CAMERA/MOTORISED LENSES		
Voltage	Current	Description
+12V	800mA max	Camera power supply
+5V	15mA max	Lens potentiometer power supply
From 6Vdc up to 15Vdc (adjustable)	200mA max (Focus+Zoom+Iris)	Lens motor power supply

Tab. 2

Lenses with reverse polarity motors: Implement the connections, as shown in the figure..

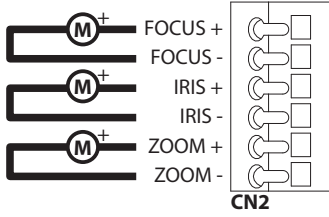

Fig. 17 CN2.

Lenses with common wire motors: Implement the connections, as shown in the figure..

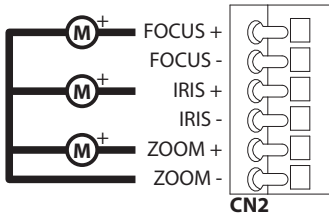

Fig. 18 CN2.

Potentiometers: Implement the connections, as shown in the figure..

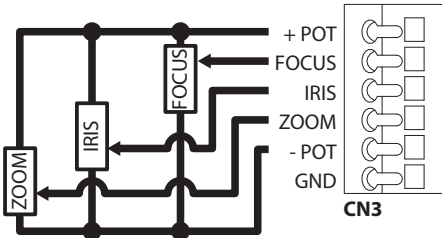

Fig. 19 CN3.

Camera: Implement the connections, as shown in the figure..

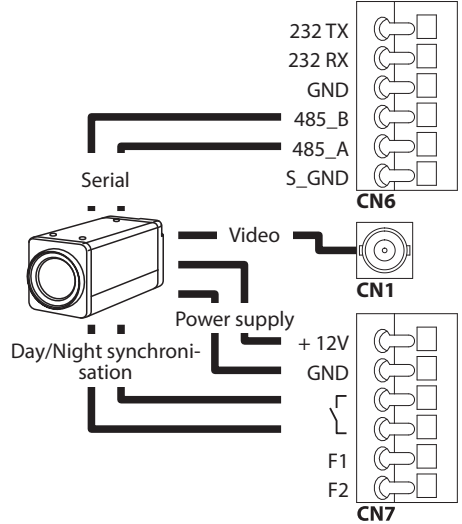

Fig. 20

Refer to the relative chapter to enable camera control (10.1.6 Housing Serial Port Menu, page 45).

7.4.2 Adjustment of the supply voltage of the lens motors

Before powering the Pan & Tilt, select the lens power voltage using DIP1 (7.4 Housing board description, page 17).

ADJUSTMENT OF THE SUPPLY VOLTAGE OF THE LENS MOTORS		
SW1	SW2	Voltage
OFF	OFF	15Vdc
ON	OFF	12Vdc
OFF	ON	9Vdc
ON	ON	6Vdc

Tab. 3

8 Installation



Never, under any circumstances, make any changes or connections that are not shown in this handbook. Failure to follow the connection instructions that are given in the handbook may create serious safety hazards for people and for the installation.



Do not change the wiring in the product as it is supplied to you. Failure to follow this instruction may create serious safety hazards for people and for the installation, and will also invalidate the guarantee.



If using the washer kit, the nozzle support should be installed before positioning the pan & tilt and the wiring. For further explanations see the specific handbook for the kit.

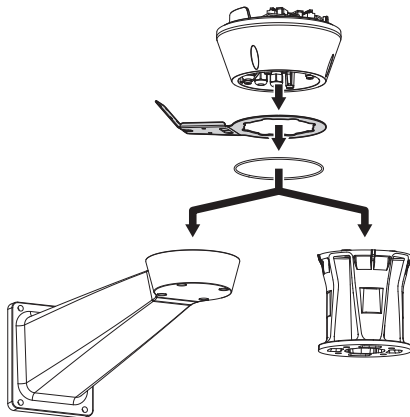

Fig. 21



Inside the bottom cover there is a desiccant bag that is used to prevent moisture formation in the base and near the connector boards. Remove the bag before installation.

8.1 Connecting the cables to the base

Insert the cables into the cable glands holding the base at about 20cm from the support. Tighten the cable glands. The cable glands are suitable for cables with a diameter between 5mm and 10 mm.

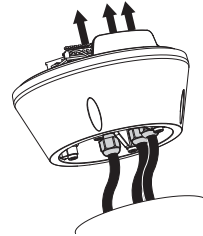

Fig. 22



Pay attention to the fixing. Tightening torque: 5Nm.



For cables diameter from 3mm to 7mm use the supplied gaskets.

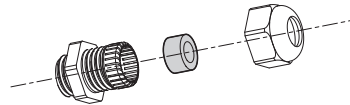

Fig. 23

8.2 Fixing the base to the support



Use the screws and the washers supplied with the base.

Once you have positioned the gasket (01), fix the base (02) onto the bracket (03) with screws (04), serrated washers (05) and screw rings (06).

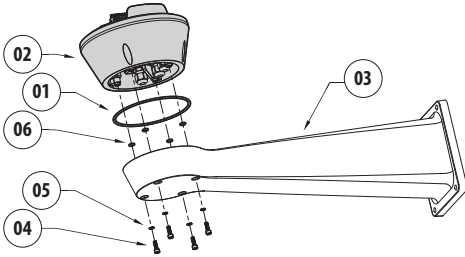

Fig. 24

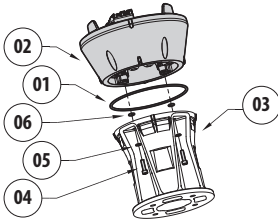

Fig. 25

Align the 3 notches on the base with those on the support as shown in the following figure.

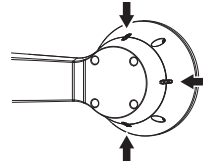

Fig. 26



Apply a thread-locker on the holes of the screws (Loctite 243®).



Pay attention to the fixing. Tightening torque: 6Nm.

Tab. 4

8.3 Connector board description

CONNECTOR BOARD DESCRIPTION	
Connector/Component	Function
J6	Board power supply
J7	Signal cables
J4	RS-232
F1	Fuse
F2	Fuse

Tab. 5 Standard version.

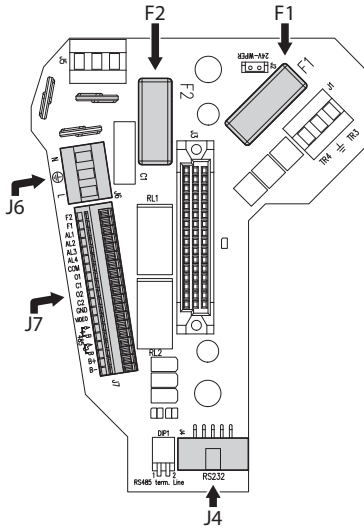

Fig. 27 Standard version.

CONNECTOR BOARD DESCRIPTION	
Connector/Component	Function
J6	Board power supply
J7	Signal cables
J4	RS-232
F1	Fuse
F2	Fuse

Tab. 6 Version with LED illuminators.

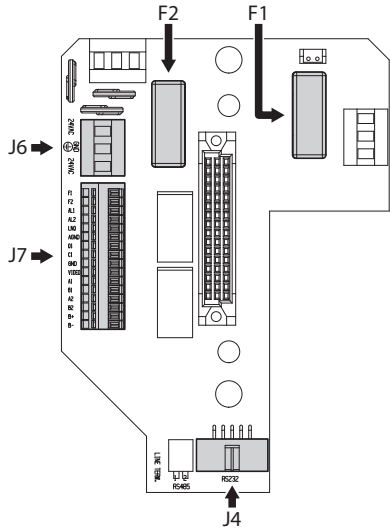

Fig. 28 Version with LED illuminators.

8.4 Connection of the power supply line

Depending on the version, the device can be provided with different power supply voltages. The power supply voltage is indicated on the product identification label. (4.2 Product markings, page 10).

⚠ Electrical connections must be performed with the power supply disconnected and the circuit-breaker open.

⚠ When commencing installation make sure that the specifications for the power supply for the installation correspond with those required by the device.

⚠ Check that the power supply socket and cable are adequately dimensioned.

⚠ Earth cable should be about 10mm longer than the other two, so that it will not be disconnected accidentally if pulled.

⚠ The power supply cable must be covered by the silicone sheath (01) supplied. The silicone sheath must be fastened with the corresponding tie (02).

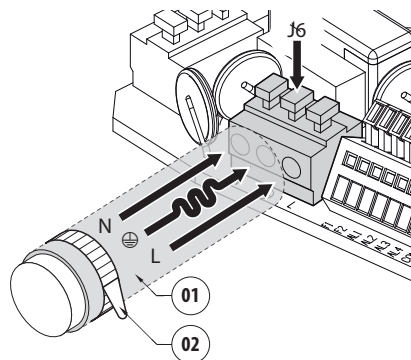

Fig. 29

8.4.1 24Vac power line connection

Cut the cables to the correct length and make the connections. Connect the power supply to the terminal: J6.

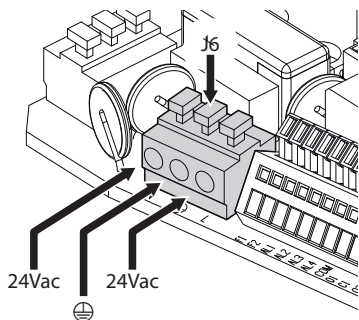

Fig. 30 Standard version.

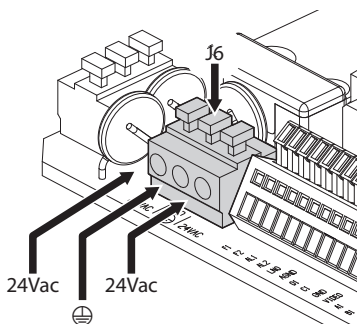

Fig. 31 Version with LED illuminators.

Connect the power supply cables as described in the table below.

CONNECTION OF THE POWER SUPPLY LINE	
Colour	Terminals
Power supply 24Vac	
Defined by the installer	24Vac
Defined by the installer	24Vac
Yellow/Green	⊕

Tab. 7

8.4.2 120Vac and 230Vac power line connection

Cut the cables to the correct length and make the connections. Connect the power supply to the terminal: J6.

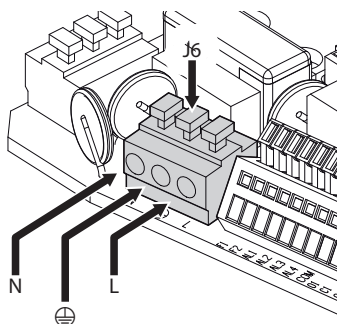

Fig. 32 Standard version.

Connect the power supply cables as described in the table below.

CONNECTION OF THE POWER SUPPLY LINE	
Colour	Terminals
Power supply 230Vac	
Blue	N (Neutral)
Brown	L (Phase)
Yellow/Green	⊕
Power supply 120Vac	
Blue	N (Neutral)
Brown	L (Phase)
Yellow/Green	⊕

Tab. 8

8.5 Signal cable connection



All signal cables must be grouped together by means of a strap.

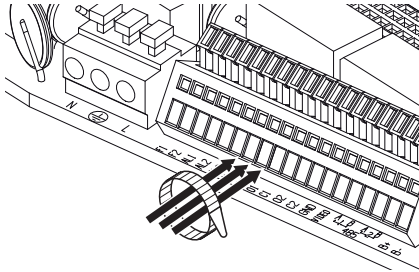

Fig. 33

8.5.1 Video cable connection



CAUTION! In order to reduce the risk of fire, only use UL Listed or CSA certified cables with sections greater than or equal to 0.14mm^2 (26AWG).



CDS installation type (Cable Distribution System). The installation is type TNV-1, do not connect it to SELV circuits.



Connect the screen and central cable respectively to the GND and VIDEO terminals. The terminals accept cables with sections between 0.5mm^2 (20 AWG) and 0.08mm^2 (28AWG).

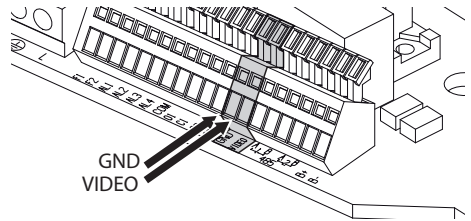

Fig. 34 Standard version.

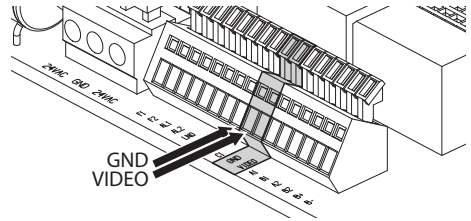

Fig. 35 Version with LED illuminators.

8.5.2 Telemetry lines connections

CAUTION! TNV-1 installation type. The installation is type TNV-1, do not connect it to SELV circuits.

CAUTION! In order to reduce the risk of fire, only use UL Listed or CSA certified cables with sections greater than or equal to 0.14mm² (26AWG).

The product is supplied with two RS-485 serial communication lines and one RS-232 serial line (only for firmware update).

The telemetry lines can be configured in various ways according to the positions of dip-switches 10 and 9 on the Serial and Address selector (8.14.4.2 Setting of the serial communication lines, page 35).

Serial lines RS-485

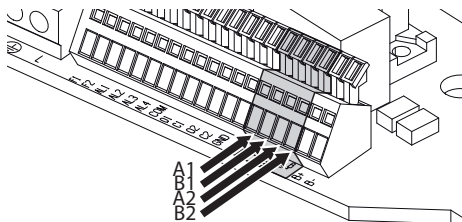

Fig. 36 RS-485. Standard version.

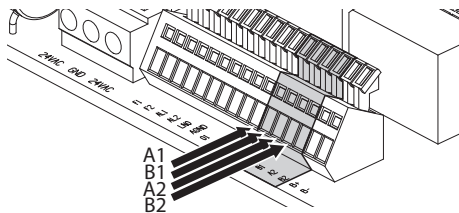

Fig. 37 RS-485. Version with LED illuminators.

TELEMETRY LINES CONNECTIONS	
Terminals	Description
A1-B1	RS-485 line (1)
A2-B2	RS-485 line (2)

Tab. 9

Serial line RS-232

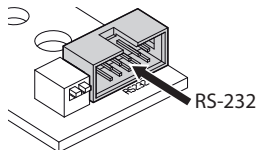

Fig. 38 RS-232.

8.5.3 Connection of the alarm inputs, of the twilight switch and of the relays

CAUTION! TNV-1 installation type. The installation is type TNV-1, do not connect it to SELV circuits.

CAUTION! In order to reduce the risk of fire, only use UL Listed or CSA certified cables with sections greater than or equal to 0.14mm² (26AWG).

Standard version

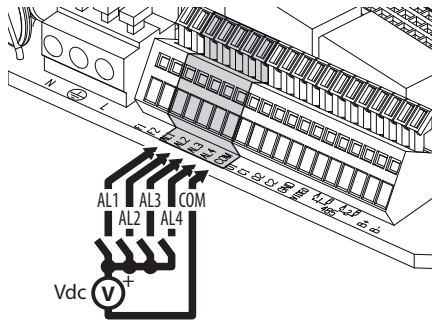

Fig. 39 Alarm input.

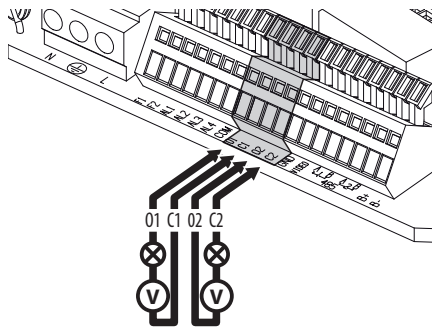

Fig. 40 Relay.

CONNECTION OF THE ALARM INPUTS AND RELAYS	
Terminals	Description
AL1, AL2, AL3, AL4 e COM	Voltage-controlled alarm inputs referred to the COM shared terminal
F1-F2	Reserved for future use
O1-C1 e O2-C2	Clean output contacts, can be activated by alarm or by user control

Tab. 10 Standard version.

Version with LED illuminators

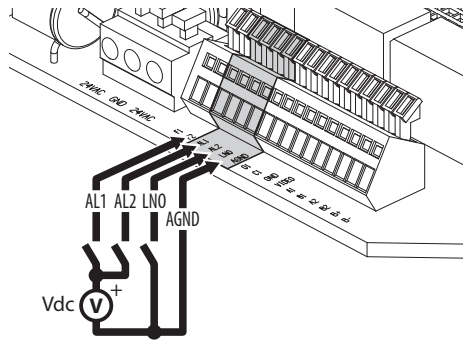

Fig. 41 Alarm inputs and twilight switch..

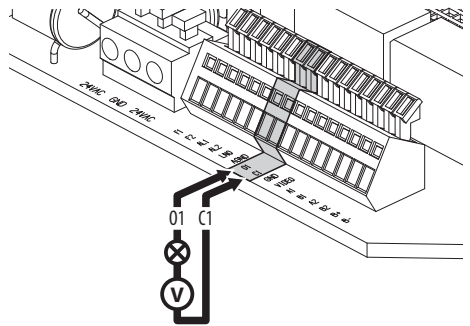

Fig. 42 Relay.

CONNECTION OF THE ALARM INPUTS, OF THE TWILIGHT SWITCH AND OF THE RELAYS	
Terminals	Description
AL1, AL2 e AGND	Voltage-controlled alarm inputs referred to the AGND shared terminal
F1-F2	Reserved for future use
LNO e AGND	Light sensitive switch (dry contact)
O1-C1	Clean output contacts, can be activated by alarm or by user control

Tab. 11 Version with LED illuminators.

8.6 Fixing the upper body

Fix the upper body (01) to the base (02) using the fixing screws (03) equipped with gaskets (04). Make sure the base seal is present and in good condition (05).

⚠ Pay attention to the fixing. Tightening torque: 4Nm.

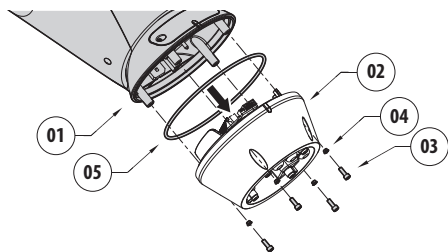

Fig. 43

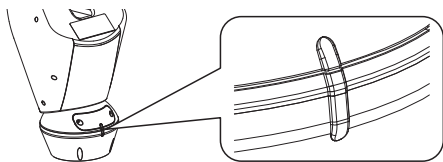

Fig. 44

i There is one anchoring position between the base and upper body. Align side projections to obtain the correct positioning.

8.7 Counterweights installation

Fasten the counterweights to the housing using the screws and washers supplied.

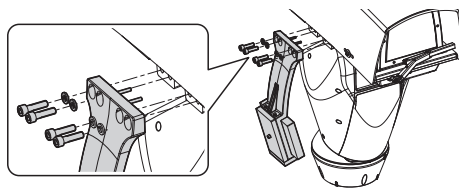

Fig. 45

⚠ Apply a thread-locker on the holes of the screws (Loctite 243®).

⚠ Pay attention to the fixing. Tightening torque: 16Nm.

8.8 LED illuminators installation



To work properly both illuminators must be installed together.



From Pan & Tilt, it is only possible to install VIDEOTEC illuminators.

8.8.1 Counterweight removal

Undo the screws and remove the external counterweights.

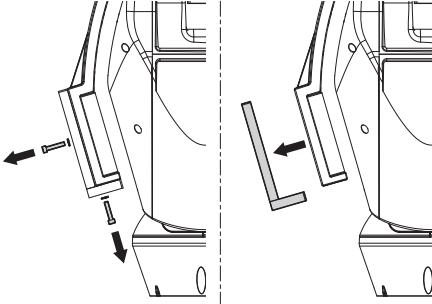

Fig. 46

8.8.2 Fitting the illuminator on the bracket

Identify the front holes on the counter-weight bracket.

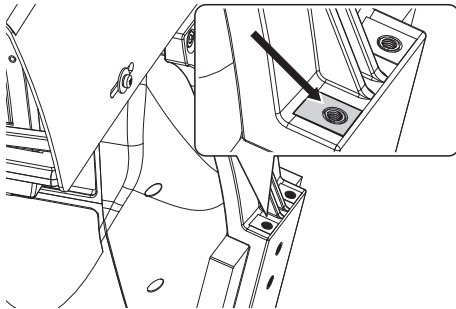

Fig. 47

Place the fixings of the illuminator (01) on those of the bracket (02).

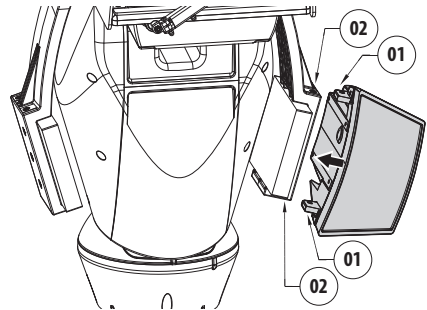

Fig. 48

Tighten the screws and the washers previously removed.

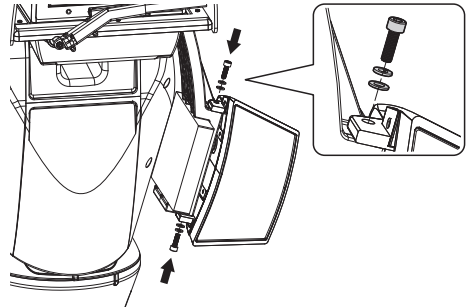

Fig. 49



Pay attention to the fixing. Tightening torque: 6Nm.

8.9 Connection of the LED illuminators

Remove the 2 M12 caps. Tighten the 2 cable glands and relative O-rings supplied.

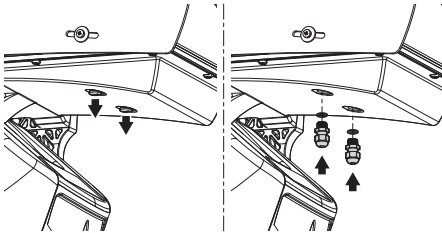

Fig. 50



To ensure the safety and the correct operation of the unit do not leave a surplus of the cable externally.

Fig. 51

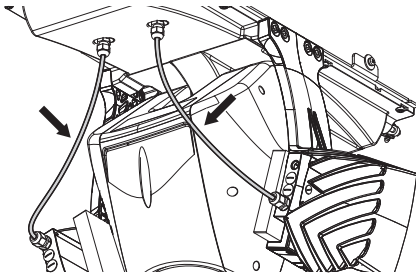

Fig. 52

Connect the cables as shown in figure.

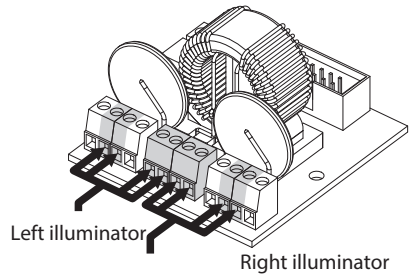

Fig. 53

CONNECTION OF THE LED ILLUMINATORS			
Left illuminator		Right illuminator	
Reference on the board	Cable color	Reference on the board	Cable color
WH	White	WH	White
BK	Black	BK	Black
A1	Green	A2	Green
B1	Red	B2	Red

Tab. 12

8.10 Connection for cameras and LED illuminators synchronisation

ZFI cameras fitted with infrared filter: Connect the camera's Day/Night mode switching input to the Night Mode connector (dry contact) as shown in figure.

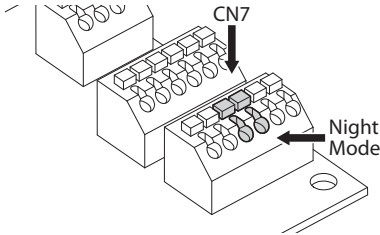

Fig. 54

8.11 Desiccant bag

Insert the desiccant bags (01) in the position indicated in the illustration, after having taken them out from the transparent packaging and folding them in half. Fasten the sachets by means of the plates (02) and screws supplied (03).

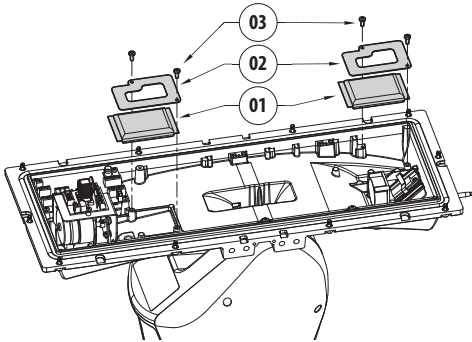

Fig. 55

8.12 LED illuminator activation and adjustment instructions

Once the adjustment is done the illuminator on the left (MASTER) synchronizes and controls the illuminator on the right (SLAVE).

The dusk switch detects the room light and controls the activation and deactivation of the illuminators when brightness reaches the level set by the user.

A Day/Night switching signal is provided to the camera upon activation of the LED illuminators (8.10 Connection for cameras and LED illuminators synchronisation, page 30).

8.12.1 Description of the LED illuminator

⚠ Do not remove the transparent screw of the twilight sensor in order not to affect the security and operation of the illuminator.

- **Twilight sensor:** Detects the light level.
- **Cable:** Power supply and control.
- **Switch-on threshold regulator:** The potentiometer allows adjusting the sensitivity threshold to switch on the illuminator.
- **Infrared power control:** The potentiometer allows adjusting the power of the illuminator.

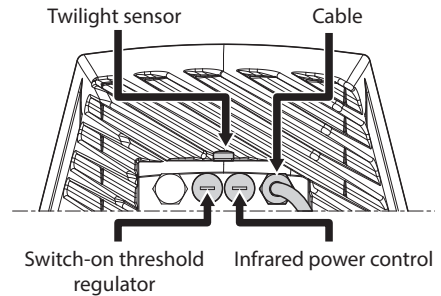

Fig. 56

8.12.2 Activation of the LED illuminator via an external dusk switch

Perform the following operations:

- Connect the twilight switch to the terminals: LNO/AGND (8.5.3 Connection of the alarm inputs, of the twilight switch and of the relays, page 26).
- Adjust the left illuminator (MASTER):
 - **Lighting threshold:** Set the value to the minimum (8.12.4 LED illuminator switching on threshold adjustment, page 32).
 - **Infrared power:** Set the value as needed (8.12.5 LED illuminator power adjustment, page 32).
- Adjustment of the the illuminator on the right (SLAVE):
 - **Lighting threshold:** Set the value to the maximum (8.12.4 LED illuminator switching on threshold adjustment, page 32).
 - **Infrared power:** Set the value to the minimum (8.12.5 LED illuminator power adjustment, page 32).
- Combine the External value with the IR Probe entry of the ZFI Parameter menu (10.1.5 ZFI Parameter Menu, page 42).

```

ZFI CAMERA SETTINGS
-----
1>ZOOM           :    30x

3 IR PROBE       :    EXT.
4 ZONE TITLING   :    >
5 ZONE MASKING   :    >
```

Fig. 57

8.12.3 Activation of the LED illuminator via the integrated dusk sensor

To synchronise the unit with the LED illuminators it is necessary to:

- Adjust the left illuminator (MASTER):
 - **Lighting threshold:** Set the value as needed (8.12.4 LED illuminator switching on threshold adjustment, page 32).
 - **Infrared power:** Set the value as needed (8.12.5 LED illuminator power adjustment, page 32).
- Adjustment of the the illuminator on the right (SLAVE):
 - **Lighting threshold:** Set the value to the maximum (8.12.4 LED illuminator switching on threshold adjustment, page 32).
 - **Infrared power:** Set the value to the minimum (8.12.5 LED illuminator power adjustment, page 32).
- Combine the Internal value with the IR probe entry of the ZFI Parameter menu (10.1.5 ZFI Parameter Menu, page 42).

```

ZFI CAMERA SETTINGS
-----
1>ZOOM           :    30x

3 IR PROBE       :    INT.
4 ZONE TITLING   :    >
5 ZONE MASKING   :    >
```

Fig. 58

8.12.4 LED illuminator switching on threshold adjustment

! The illuminator on the right must always be set to maximum brightness.

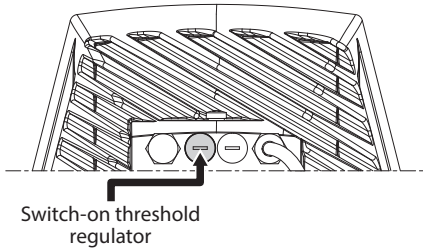

Fig. 59

The illuminator has an integrated twilight sensor that allows its automatic activation and deactivation at predefined luminous conditions.

The twilight sensor is set in the factory at a predetermined luminous level, suitable for most installations (approximately 50lx). If you want to adjust in different ways the threshold, loosen the plug on the illuminator rear and proceed for the adjustment with a screwdriver.

By rotating the trimmer clockwise, the night mode changeover is anticipated (at a greater luminous value). By rotating the trimmer anti-clockwise, the night mode changeover is delayed (at a lower luminous value).

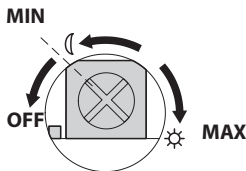

Fig. 60

Wait for appropriate brightness before switching on the illuminator. Rotate the trimmer slowly until the LED on the side of the trimmer switches on. Once the intervention threshold has been surpassed (LED on), rotate it slightly in the opposite direction.

! After making the adjustments make sure that the plug is closed tight to ensure perfect sealing.

8.12.5 LED illuminator power adjustment

! The illuminator on the right must always be set to minimum power.

The illuminator is set in the factory to provide maximum power. If you don't need to illuminate distant subjects or if the image is over-exposed for excessive brightness, decrease the power, so that energy saving is also obtained.

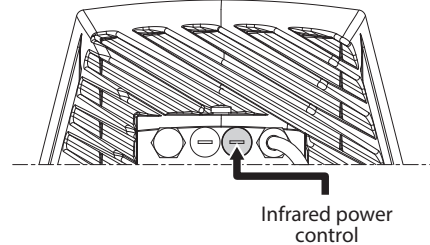

Fig. 61

Loosen the hermetic plug. Rotate the trimmer, clockwise to increase the power of the infrared illuminators and anti-clockwise to decrease it.

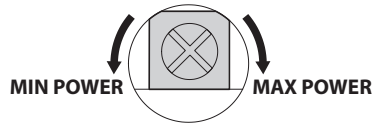

Fig. 62

! After making the adjustments make sure that the plug is closed tight to ensure perfect sealing.

8.13 Fastening of the wiper blade

Insert the blade on the wiper shaft.

Position the blade in the stop position.

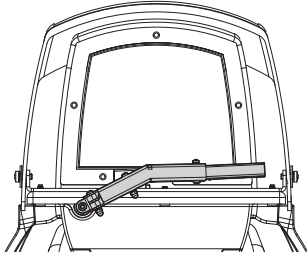

Fig. 63

Fasten the whole assembly by means of the washer and nut.

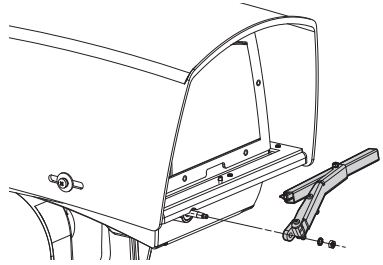

Fig. 64



The correct adjustment must allow the return of the blade to the stop position going to the end stop on the casing's plate.

8.14 Hardware configuration

8.14.1 Opening the configuration door

Before powering the device it must be configured correctly by setting the dip-switches inside the configuration window. Open the hatch by undoing the screws as shown in figure.

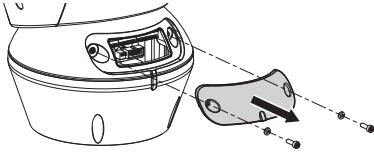

Fig. 65

The DIP-switches appear as shown in the figure.

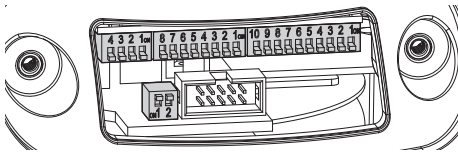

Fig. 66

i After installation and wiring, close the product again.

8.14.2 DIP1 configuration

i When the switch rocker is up it represents the value 1 (ON). When the dip-switch rocker is down it represents the value 0 (OFF).

Switch 1 is used to update the firmware.

Switches 4, 3 and 2 are used to select the communication rate of the device.

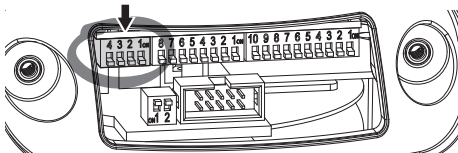

Fig. 67

DIP1 CONFIGURATION					
Description	SW 4	SW 3	SW 2	SW 1	Baud rate
Baud rate adjustment	OFF	OFF	OFF	–	300 baud
	ON	OFF	OFF	–	600 baud
	OFF	ON	OFF	–	1200 baud
	ON	ON	OFF	–	2400 baud
	OFF	OFF	ON	–	4800 baud
	ON	OFF	ON	–	9600 baud
	OFF	ON	ON	–	19200 baud
	ON	ON	ON	–	38400 baud
Firmware update	–	–	–	ON	Set up enabled
	–	–	–	OFF	Set up disabled

Fig. 68

8.14.3 DIP2 configuration

i When the switch rocker is up it represents the value 1 (ON). When the dip-switch rocker is down it represents the value 0 (OFF).

The Pan & Tilt can be controlled via various protocols.

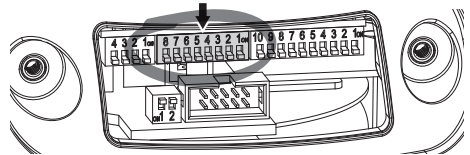

Fig. 69

DIP2 CONFIGURATION								
Protocol	SW 8	SW 7	SW 6	SW 5	SW 4	SW 3	SW 2	SW 1
PTZ Manager ¹	OFF	OFF	OFF	OFF	OFF	OFF	OFF	OFF
MACRO (VIDEOTEC)	OFF	OFF	OFF	OFF	OFF	ON	ON	ON
PANASONIC	OFF	OFF	OFF	ON	OFF	ON	OFF	OFF
PELCO D	OFF	OFF	OFF	OFF	ON	OFF	OFF	ON
AMERICAN DYNAMICS	OFF	OFF	OFF	OFF	ON	ON	ON	OFF
VISTA	OFF	OFF	OFF	ON	OFF	OFF	ON	ON

Tab. 13 ¹ Default configuration: MACRO (VIDEOTEC), 115200 baud, Address 1. This option does not require the setting of the DIP-switch (DIP1, DIP3).

Tab. 14

8.14.4 DIP3 configuration

i When the switch rocker is up it represents the value 1 (ON). When the dip-switch rocker is down it represents the value 0 (OFF).

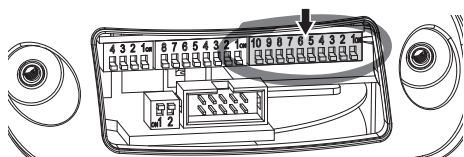

Fig. 70

8.14.4.1 Address configuration

Switches from 1 to 8 are used to configure the unit address (from 1 to 255).

Binary code is used to select the address (A Appendix - Address table, page 66).

8.14.4.2 Setting of the serial communication lines

The product is supplied with two RS-485 serial communication lines.

Switches 10 and 9 are used to configure the serial lines.

DIP3 CONFIGURATION		
Description	SW 10	SW 9
One-way communication on RS-485-1 line	OFF	OFF
Full-duplex communication according to standard RS-422.	OFF	ON
Connection of several cascade devices. Signal is regenerated by each unit.	ON	OFF
Two-way communication, half-duplex, on RS-485-1 line.	ON	ON

Tab. 15

i For further information refer to the relative chapter (8.14.6 Installation examples, page 36).

8.14.5 DIP4 configuration

i This DIP is set following the inverse procedure compared to those previously performed. When the switch rocker is up it represents the value 0 (OFF). When the dip-switch rocker is down it represents the value 1 (ON).

The board has two switches used to configure the serial lines terminations (120 Ohm).

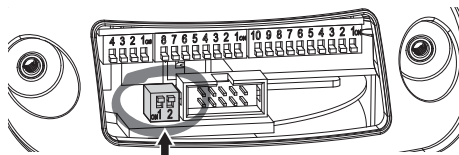

Fig. 71

Every unit that is situated at the end of a line must be terminated using the appropriate switch in order to prevent signal reflection and distortion.

Switches 1 and 2 terminate serial lines RS-485-1 and RS-485-2 respectively.

DIP4 CONFIGURATION			
Serial line	SW 2	SW 1	Description
RS-485-1 line	-	ON	Terminated
	-	OFF	Not terminated
RS-485-2 line	ON	-	Terminated
	OFF	-	Not terminated

Tab. 16

8.14.6 Installation examples

8.14.6.1 RS-485 RX line

The line RS-485-1 will operate according to the settings in the Address, Baud rate and Protocol dip-switch.

The RS-485-2 serial line is not used.

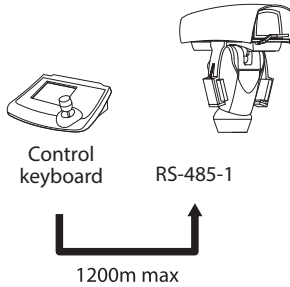

Fig. 72

CAUTION! TNV-1 installation type. The installation is type TNV-1, do not connect it to SELV circuits.

8.14.6.2 RS-422 line (RS-485-1 RX e RS-485-2 TX)

This setting allows full duplex communication according to the RS-422 standard. This means that both the RS-485-1 and RS-485-2 lines are used.

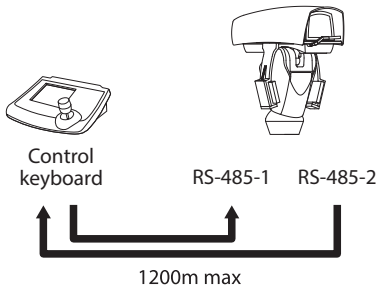

Fig. 73

i This function is only available for bi-directional protocols (example: PELCO, AMERICAN DYNAMICS, VIDEOTEC MACRO, etc.).

8.14.6.3 Line RS-485-1 reception, line RS-485-2 repetition

With this type of setting it is possible to connect more than one device in cascade. The signal is repeated from every unit, making it possible to markedly increase total distance.

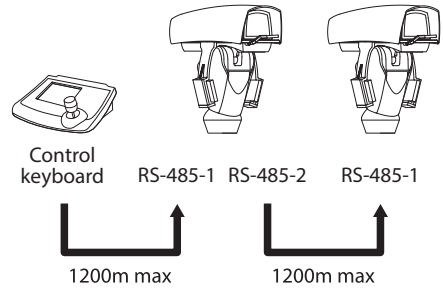

Fig. 74

i This configuration can be used with one-way protocols.

8.14.6.4 Two-way RS-485 TX/RX line

With this setting it is possible to obtain a bi-directional, half/duplex, communication on the RS-485-1 line.

The RS-485-2 serial line is not used.

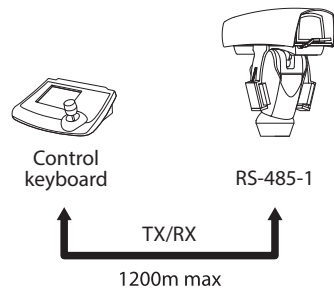

Fig. 75

i This function is only available for bi-directional protocols (example: PELCO, AMERICAN DYNAMICS, VIDEOTEC MACRO, etc.).

9 Switching on



Make sure that the unit and other components of the installation are closed so that it is impossible to come into contact with live parts.



During normal operation the surface of the illuminator can reach high temperatures. Do not allow direct contact and position the appliance where it is inaccessible to unauthorised persons. Before touching switch off the illuminator and allow to cool for a minimum period of 10 minutes.



Do not stay in the vicinity of the device when it is powered. Act on the device only in the absence of a power supply.



Make sure that all parts are fastened down firmly and safely.



The automatic pre-heating (De-Ice) process could be started whenever the device is switched on and the air temperature is below 0°C. This process is used to ensure that the device works properly even at low temperatures. The duration ranges depending on environmental conditions (from 60 minutes up to 105 minutes).

The unit is switched on by connecting the power supply.

To switch off the unit disconnect the power.

9.1 First start-up

The first time the device is switched on we recommend making sure it is configured correctly.

Before providing power supply, remove the DIP protection doors and position the firmware update switch lever to ON (8.14.2 DIP1 configuration, page 34).

Power the device. After a few seconds, you can check the configuration set on the monitor..

After completing the check, switch off the device and re-toggle the firmware update switch rocker to the down position.

Close the door and re-connect the power supply.

9.2 Checks list



Contact the assistance service if one of the checks fails the test (ERR). The message OFF means that the pan & tilt is not fitted with the described option.

While it is switching on, the device displays a list of the checks it has to carry out before starting normal operation.

STARTUP

```

-----
TEST FLASH           : OK
HOMING PROCEDURE     : OK
ZFI SEARCH           : OK
IO EXPANDER          : OFF
IR360 STATE          : OFF
  
```

Fig. 76

10 Configuration

10.1 OSM interface (On Screen Menu)

10.1.1 Using the OSM

During normal operation of the unit, you can activate the OSM to select and configure advanced functions.. For further information, refer to the manual of the keyboard used and to the relative chapter. (12.11 Special controls, page 56).

Exit the OSM with Wide Zoom (Zoom-).

i This is a dynamic self-configuration menu based on the Pan & Tilt model.

10.1.1.1 How to use the joystick

All operations in the menus are carried out using the joystick.

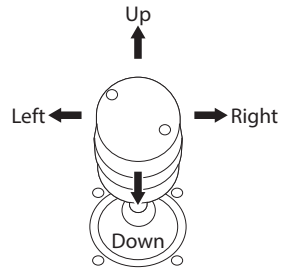

Fig. 77 Pan & tilt.

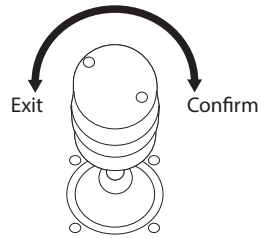

Fig. 78 Wide Zoom and Tele Zoom.

i If you use control keyboards with 2-axes joystick, use the Wide Zoom and Tele Zoom buttons to Exit and Confirm.

10.1.1.2 How to move around the menus

Each page of the OSM shows a list of parameters or sub-menus that can be selected by the operator. Move the cursor with the joystick (up and down) to scroll the various parameters .

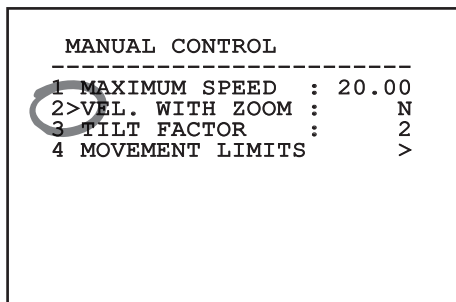

Fig. 79

The symbol > at the end of a line indicates the presence of a specific submenu. To enter the submenu just confirm the menu item. To exit the submenu use the Exit function (Zoom Wide).

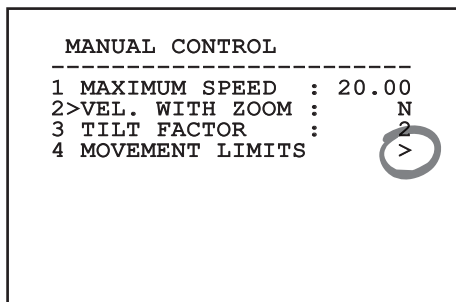

Fig. 80

10.1.1.3 How to modify the parameters

Move the cursor to the parameter to be changed and confirm. The field will start flashing, indicating that it is in change mode. Use the joystick (up and down) to show the possible options.

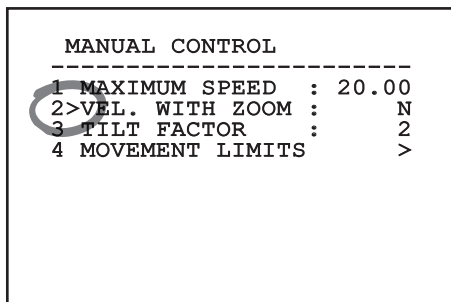

Fig. 81

Confirm after having identified the option required.

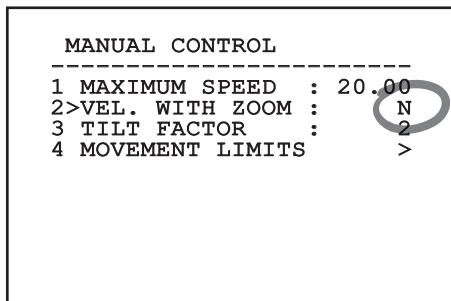

Fig. 82

The field will stop flashing to confirm the selection made.

10.1.1.4 How to change the numeric fields

Move the cursor to the parameter to be changed and confirm.

```

EDIT PRESET
-----
1 NR.      :      1
2 ENAB.    :      N
3>PAN      : +  0.00
4 TILT     : - 40.00
5 SPEED    :  20.00
6 PAUSE    :      5
7 TEXT     : PRESET 001
8 GO TO PRESET?
  
```

Fig. 83

The first digit in the numeric field to be changed will flash and the last line of the display will show the accepted limits for the field. Move in the field (left and right) and change the sign or the numeric value (up and down).

```

EDIT PRESET
-----
1 NR.      :      1
2 ENAB.    :      N
3>PAN      : +000.00
4 TILT     : - 40.00
5 SPEED    :  20.00
6 PAUSE    :      5
7 TEXT     : PRESET 001
8 GO TO PRESET?

min:-180.00 max:+179.99
  
```

Fig. 84

After making the change, confirm. The cursor returns to the left and the modified digit will stop flashing. The field will be forced to the minimum or maximum value permitted if an unexpected value is entered.

10.1.1.5 How to change text

Move the cursor to the parameter to be changed and confirm.

```

EDIT ZONE
-----
1 NR      :      1
2 START:+ 0.00
3 STOP  :+  0.00
4>TEXT  :TXT AREA1
  
```

Fig. 85

The text editing display will open. The arrow symbol is placed under the character that can be modified, whilst cursor > is positioned on the left of the selected character.

```

EDIT TEXT: AREA
-----
Text: TEXT AREA1
      ↑
>A B C D E F G   ERASE
H I J K L M N   SAVE
O P Q R S T U   EXIT
V W X Y Z 0 1   abc
2 3 4 5 6 7 8
9 : ; , ? !
\ + - * / = "
< > SPACE ← →
  
```

Fig. 86

You can move inside the menu using the joystick.

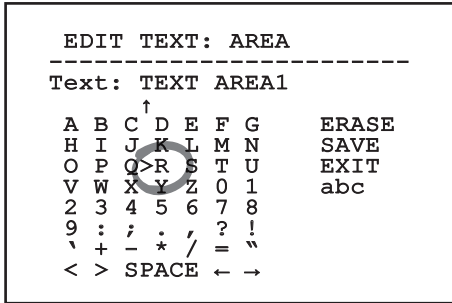

Fig. 87

The Confirm command (Zoom Tele) inserts the desired character.

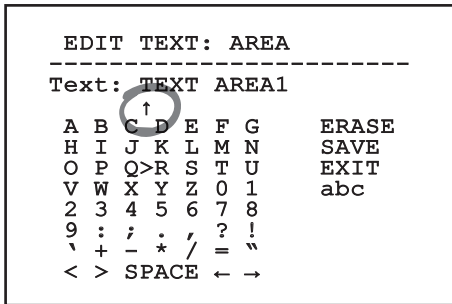

Fig. 88

Use:

- **ERASE:** Delete the whole text string.
- **SAVE:** Save the new text before exiting the menu.
- **EXIT:** Exit the menu.
- **abc:** Displays lower-case characters.

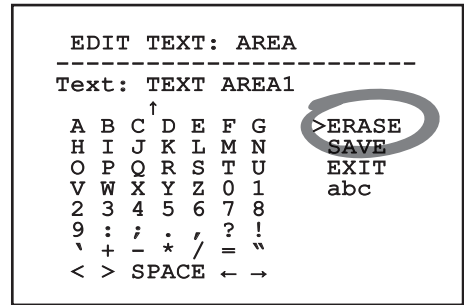

Fig. 89

To exit the menu you can also use the Zoom Wide key.

10.1.2 Configuration via OSM

The screens for configuring the product are illustrated below.

10.1.3 Main Menu

From the main menu it is possible to enter menus for configuring the device.

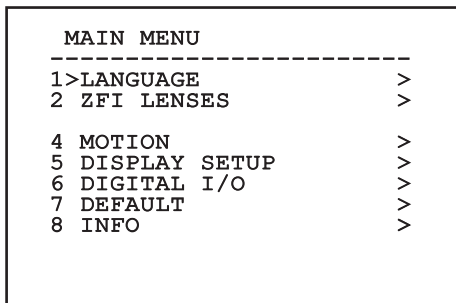

Fig. 90

This is a dynamic self-configuration menu based on the Pan & Tilt model.

10.1.4 Language Selection Menu

The menu allows you to select the language.

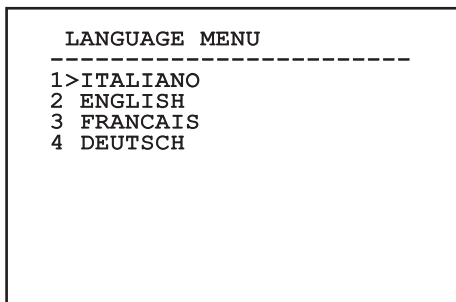

Fig. 91

10.1.5 ZFI Parameter Menu

1. **Zoom:** This sets the maximum zoom level that the motorised lens can achieve.
2. **Common Wire:** If enabled, it manages the motorised common wire lenses; if disabled, it manages those with inversed polarity.
3. **IR Probe:** It indicates the presence of a dusk switch to manage the Day/Night function of the motorised lens. Three options are available:
 - Off: Day/Night switching not enabled
 - Internal: The dusk switch is found inside the illuminators for Day/Night switching.
 - External: The dusk switch must be connected to the LNO terminal for Day/Night switching.
4. **Area Titling:** Allows access to the area titling submenu.
5. **Zone Masking:** This provides access to the zone masking management submenu.
6. **Housing Serial Port:** Allows access to the submenu for managing the housing serial port.
7. **Polarity:** Allows access to the submenu for managing the polarity of the Zoom, Focus and Iris motors.

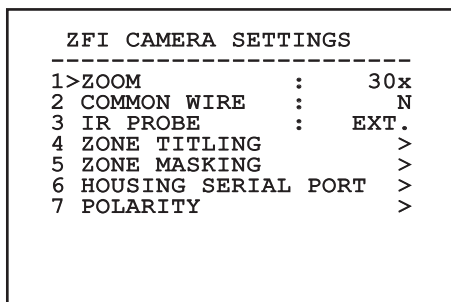

Fig. 92

10.1.5.1 Zone Titling Menu

This function allows setting up to eight (variable dimension) areas with titling option.

It allows you to configure the following parameters:

Number: Selects the area to be edited.

Enabling: Enables the message linked to the related zone to be displayed on the screen.

Start: Sets the initial position of the area.

Stop: Sets the final position of the area.

Text: Modifies the text which is displayed when moving within the zone.

ZONE TITLING			

1>NR.	:		1
2 ENAB.	:		N
3 START:	+	0.00	
4 STOP :	+	0.00	
5 TEXT :			ZONE 1

Fig. 93

Example: To enable titling of zone 1 when the device is between $+15^\circ$ and $+45^\circ$, it is necessary to:

- Enable area titling by setting Y as the value of Enabling.
- Select 1 as value of parameter No.
- Set $+015.00$ as the value of parameter Start.
- Set the Stop parameter value to $+045.00$.
- If necessary, edit the displayed text by selecting Text.

i **Setting the Start and Stop values of the menu to zero will disable text display. If there are overlapping areas, the area with the lowest number will prevail.**

i **Define the areas moving in a clockwise direction, as shown in the figure.**

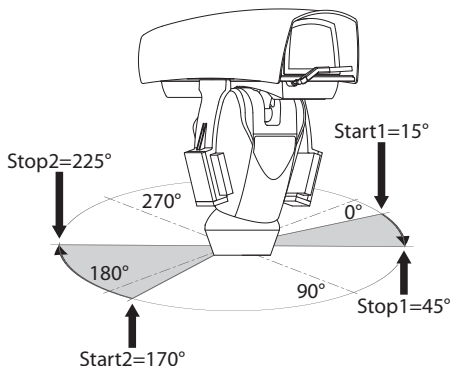

Fig. 94

10.1.5.2 Zone Masking Menu

This function allows setting up to eight masks (variable dimension) with titling option.

1. **Number:** Selects the area to be edited.
2. **Enabling:** Enables masking of the relative zone.
3. **Start:** Sets the initial position of the area.
4. **Stop:** Sets the stop position of the mask.
5. **Text:** Changes the text displayed when the mask is enabled.

```

ZONE MASKING
-----
1>NR      :          1
2 ENAB.  :          N
3 START  : + 0.00
4 STOP   : + 0.00
5 TEXT   : MASK 1

```

Fig. 95

Example: To enable masking of zone 1 when the device is in the +15° and +45° position, proceed as follows:

- Select 1 as value of parameter No.
- Enable zone masking by setting the Enabling value to Y.
- Set +015.00 as the value of parameter Start.
- Set the Stop parameter value to +045.00.
- If necessary, edit the displayed text by selecting Text.

i Set the Start and Stop menu values to zero to disable the masking option. If a number of masks are superimposed, the mask with the lowest number will prevail over the others.

i Define the masks moving in a clockwise direction, as shown in the figure.

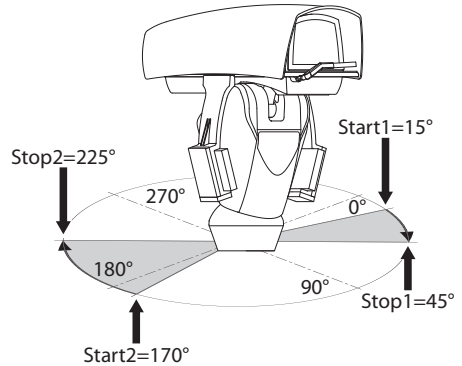

Fig. 96

10.1.6 Housing Serial Port Menu

i Once you have exited from the camera OSM, press the Iris Close key to return to the Pan & Tilt OSM.

i To prevent the camera OSM from overlapping the Pan & Tilt OSM, exit from the camera configuration mode before pressing the Iris Close key.

1. **Protocol:** It allows you to choose the protocol used in the housing serial.
2. **Baud Rate:** It allows you to choose the baud rate used in the housing serial.
3. **Return Cmd:** It replaces the Confirm control provided with the joystick with a customised option.
4. **Exit Cmd:** It replaces the Exit control provided with the joystick with a customised option.
5. **Enable Camera OSM:** Allows access to the camera configuration mode.

```

HOUSING SERIAL PORT
-----
1>PROTOCOL      :      NONE
2 BAUDRATE      :      9600
3 RETURN CMD    : IRIS CLOSE
4 EXIT CMD      : IRIS OPEN
5 ENABLE CAMERA OSM  >

```

Fig. 97

10.1.7 Polarity Menu

It allows you to configure the following parameters:

1. **Zoom:** It allows you to choose the motor rotation polarity of the lens Zoom.
2. **Focus:** It allows you to select the motor rotation polarity of the lens Focus.
3. **Iris:** It allows you to select the motor rotation polarity of the lens Iris.

```

POLARITY
-----
1>ZOOM :      POSITIVE
2 FOCUS :     POSITIVE
3 IRIS  :     POSITIVE

```

Fig. 98

10.1.8 Movement Menu

1. **Offset Pan:** The pan & tilt has a mechanically defined 0° position. The Offset Pan function allows the definition of a different 0° position using software.
2. **Manual Control:** To access the submenus operating the parameters associated with the manual movements of the device.
3. **Preset:** To access the submenus used to edit Preset values.
4. **Patrol:** To access the submenus used to edit Patrol values.
5. **Autopan:** To access the submenus used to edit Autopan values.
6. **Motions Recall:** To access the submenu which manages automatic load of the movements.

```

MOTION
-----
1>OFFSET PAN:      + 20.00
2 MANUAL CONTROL  >
3 PRESET          >
4 PATROL         >
5 AUTOPAN        >
6 MOTIONS RECALL >
  
```

Fig. 99

10.1.8.1 Manual Control Menu

1. **Maximum Speed:** Select the maximum manual speed.
2. **Speed With Zoom:** When enabled, this parameter automatically slows down the Pan & Tilt speed, based on the Zoom factor.
3. **Tilt Factor:** Select the tilt axis manual speed reduction function.
4. **Movement Limits:** Access the Limit menu.

```

MANUAL CONTROL
-----
1>MAXIMUM SPEED : 20.00
2 VEL. WITH ZOOM : N
3 TILT FACTOR   : 2
4 MOVEMENT LIMITS >
  
```

Fig. 100

10.1.8.2 Manual Control Menu (Limits)

It allows you to configure the following parameters:

1. **Pan Limits:** Enables the limits of Pan.
2. **Pan Start:** Sets the start limit of Pan.
3. **Pan End:** Sets the end limit of Pan.
4. **Tilt Start:** Sets the start limit of Tilt.
5. **Tilt End:** Sets the end limit of Tilt.

```

LIMITS
-----
1>PAN LIMITS      :          N
2 PAN START      : +   0.00
3 PAN END        : +   0.00
4 TILT START     : +   0.00
5 TILT END       : +   0.00
  
```

Fig. 101

This is a dynamic self-configuration menu based on the choice made and shows the parameters on which it is possible to operate.

10.1.8.3 Preset Menu

1. **Edit Preset:** To access the Modifica Preset (Preset Modification) menu.
2. **Utility Preset:** To access the Utilità Preset (Preset Utility) menu

```

PRESET
-----
1>EDIT PRESET      >
2 PRESET UTILITIES >
  
```

Fig. 102

10.1.8.4 Preset Menu (Edit Preset)

It allows you to configure the following parameters:

1. **Number:** The Preset number to be edited.
2. **Enabling:** Enabling preset.
3. **Pan:** Pan position in degrees.
4. **Tilt:** Tilt position in degrees.
5. **Speed:** Position approaching speed when preset is restored by the Patrol and Autopan functions.
6. **Pause:** The dwell time in seconds before starting the next movement in Patrol.
7. **Text:** The text that is displayed when the preset position is reached.
8. **Go To Preset?:** Obliges the Pan & Tilt to move to the selected Preset position.
9. **Enable Movements:** It allows you to choose a new frame.

```

EDIT PRESET
-----
1>NR.      :          1
2 ENAB.    :          N
3 PAN      : +   0.00
4 TILT     : -  40.00
5 SPEED    :   20.00
6 PAUSE    :          5
7 TEXT     : PRESET 001
8 GO TO PRESET?
9 ENABLE MOVEMENTS      >
  
```

Fig. 103

From the menu it is possible to directly store the preset by sending the Iris Close command that enables the pan & tilt movements.

10.1.8.5 Preset Menu (Utility Preset)

It allows you to configure the following parameters:

1. **Scan Speed:** Speed used to reach the Preset position after reception of a Scan control.
2. **Default Speed:** Preset default speed. This value is used by function "Imponi Vel.?" (Force Speed) to assign the same Preset speed.
3. **Default Dwell Time:** Preset default pause. This value is used by function "Imponi Pausa?" (Force Pause) to assign the same pause to each preset.
4. **Ramp Value:** Start and stop times. The higher the number, the greater the acceleration/ deceleration during starting/stopping.
5. **Set Speed?:** To assign all Presets the same default speed.
6. **Set Dwell Time?:** To assign all Presets the same default dwell time.

```

PRESET UTILITIES
-----
1>SCAN SPEED      : 20.00
2 DEFAULT SPEED   : 10.00
3 DEFAULT DWELL   :      3
4 RAMP VALUE      :     12
5 SET SPEED?
6 SET DWELL TIME?
  
```

Fig. 104

10.1.8.6 Patrol Menu

1. **First Preset:** First preset of the Patrol sequence.
2. **Last Preset:** Last preset of the Patrol sequence.
3. **Random Mode:** Enables random execution. The sequence is re-calculated on a continuous basis.

```

PATROL
-----
1>FIRST PRESET    :      1
2 LAST PRESET     :    250
3 RANDOM MODE     :      N
  
```

Fig. 105

10.1.8.7 Autopan Menu

1. **Preset Outward Movement:** Autopan initial position.
2. **Preset Return Movement:** Autopan final position.

```

AUTO-PAN
-----
1>PRESET OUTWARD :      1
2 PRESET RETURN  :      2
  
```

Fig. 106



The Preset position approaching speed is defined in the relative chapter (10.1.8.4 Preset Menu (Edit Preset), page 47).

10.1.8.8 Motion Recall Menu

The unit can be configured so that, after a period of non-use, it carries out a movement function selected by the operator.

1. **Movement Type:** Type of movement to be loaded (None, Home, Autopan, Patrol).
2. **Movement Delay:** The standby time of the joystick is expressed in seconds.

```

MOTION RECALL
-----
1>MOVEMENT TYPE :    NONE
2 MOVEMENT DELAY:    60
  
```

Fig. 107

10.1.9 Display Menu

1. **Actual Position:** Is not set to OFF, you are able to select the display mode of the Pan, Tilt, Zoom, Focus, and Iris values.
2. **Preset Name:** If not set to OFF, you are able to select the display mode of the text associated with the last Preset position. It is possible to select timed (1 s, 3 s and 5 s) or a constant (Const) display.
3. **Pan & Tilt ID:** If not on OFF, it shows the ID of the product.
4. **Alarms:** If not set to OFF, you are able to select the display mode of the alarm texts. It is possible to select timed (1 s, 3 s and 5 s) or a constant (Const) display.

5. **Received Commands:** If enabled, it shows the received serial commands.
6. **Horizontal Delta:** Horizontal displacement of the menu texts to improve centring.
7. **Vertical Delta:** Vertical displacement of the menu texts to improve centring.
8. **Video Signal:** Video signal format.

```

DISPLAY
-----
1 ACTUAL POSITION :    ON
2 PRESET NAME   :    5 S
3 UNIT ID      :    ON
4 ALARMS       :    ON
5 RECEIVED COMMAND: ON
6 HORIZONTAL DELTA: 35
7 VERTICAL DELTA : 10
8 VIDEO SIGNAL  :    PAL
  
```

Fig. 108

This is a dynamic self-configuration menu based on the Pan & Tilt model.

10.1.10 Digital I/O-Options Menu

1. **Alarms:** Access the alarm menu.
2. **Washer:** Access the Washing System menu.
3. **Communications:** Access the Communications menu.

```

DIGITAL I/O-OPTIONS
-----
1>ALARMS                >
2 WASHER                >
3 COMMUNICATIONS       >
  
```

Fig. 109

10.1.10.1 Alarms Menu

- 01-04. **Alarms 1-4:** Access the menus, which allow you to modify the Alarm parameters from 1 to 4.
05. **Alarms State:** Access the Alarm Status menu.

```

ALARM
-----
1>ALARM 1          >
2 ALARM 2          >
3 ALARM 3          >
4 ALARM 4          >
5 ALARMS STATE    >

```

Fig. 110

This is a dynamic self-configuration menu based on the Pan & Tilt model.

The single alarms menu allows you to configure the following values:

1. **Type:** Type of contact, normally closed (N.C.) or normally open (N.O.).
2. **Action:** The type of action carried out by P&T when the alarm triggers (Off, Msg, PTZ Stop, Wiper, Washer, Scan, Patrol, Autopan, Relay, Ir Filt). The OFF parameter disables the alarm.
3. **Number:** The preset to be reached when the alarm's type of action is Scan.
4. **Text:** This message is displayed when the alarm is active.

```

ALARM 1
-----
1>TYPE :      N.C.
2 ACT. :      SCAN
3 NR.  :      1
4 TEXT : ALARM 1

```

Fig. 111

This is a dynamic self-configuration menu based on the choice made and shows the parameters on which it is possible to operate.

The Alarm Status menu shows the input status of the alarms (Closed, Open).

```

ALARMS STATE
-----
ALARM 1          CLOSED
ALARM 2          OPEN
ALLARME 3        CLOSED
ALLARME 4        CLOSED

```

Fig. 112

10.1.10.2 Communication menu

1. **Serial ACK:** Configure the Pan & Tilt to enable/disable the sending of an ACK response to the serial commands.
2. **ACK PELCO D Standard:** Configure the PELCO D command ACK response. The menu is invisible if the communication protocol set by the DIP switches is not PELCO D or if the ACK response is not enabled (SERIAL ACK = FALSE). If the menu item is enabled, the ACK response is the standard type (checksum correlated to the original message). If the menu item is disabled, the checksum is only calculated on the ACK package itself.

```

COMMUNICATIONS
-----
1 SERIAL ACK      : Y
2 DEFAULT PELCOD ACK : N

```

Fig. 113

10.1.10.3 Washer Menu

The unit offers the possibility to use a wiper and to operate a pump to clean the glass.

To configure the Washer put the lens of the camera in front of the nozzle of the Washer.

Save a preset (XY) that identifies this position; the preset will be recalled by the pan & tilt when the WASHER function is enabled.

Configure the following parameters:

1. **Enable:** Enabling the Washer function.
2. **Nozzle Preset:** Enter the preset number (XY) corresponding to the nozzle.
3. **Wiper On Delay:** Select the time interval between the pump and wiper.
4. **Washing Length:** Choose the duration of brushing.
5. **Wiper Off Delay:** Choose the duration of brushing without water.

```

WASHER
-----
1>ENABLE           :  N
2 NOZZLE PRESET   :  1
3 WIPER-ON DELAY :  5
4 WASHING DURATION : 10
5 WIPER-OFF DELAY :  5
  
```

Fig. 114

10.1.11 Default Menu

1. **Delete Setup?:** Resets all the parameters except the Presets.
2. **Delete Preset?:** Deletes all previously stored presets.

```

DEFAULT
-----
1>DELETE SETUP?
2 DELETE PRESET?
  
```

Fig. 115

 **The above mentioned operations cause the loss of all previously stored data (i.g. Preset, Patrol, Autopan, Home...).**

10.1.12 Info Menu

The menu is used to check the configuration of the device and the installed firmware version.

```

INFO
-----
Device ID: 00001
Type      : Rs485 only Rx
Baud Rate: 38400-8N1
Protocol  : MACRO
Net Board: Fw6.02 Hw01
Mpp Board: Fw6.02 Hw00
Config.   : 001
P.C.      : UPT1SVSA000E
S.N.      : 000000000000
Upgrade   : NET BOARD
  
```

Fig. 116

11 Accessories

i For further details on configuration and use, refer to the relative manual.

11.1 Washer

The P&T can be equipped with an external pump that supplies water for the glass to be cleaned.

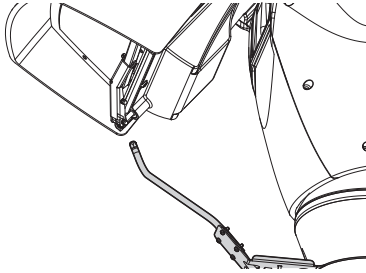

Fig. 117

11.1.1 Washing system connection

! **CAUTION!** TNV-1 installation type. The installation is type TNV-1, do not connect it to SELV circuits.

! **CAUTION!** In order to reduce the risk of fire, only use UL Listed or CSA certified cables with sections greater than or equal to 0.14mm² (26AWG).

! All signal cables must be grouped together by means of a strap.

WASHING SYSTEM CONNECTION	
Terminals	Description
AL1-COM AL1-AGND	Alarm input. The washing systems provided with level sensor indicate the absence of liquid in the tank.
O1-C1	Clean contact to activate the washing system.

Tab. 17

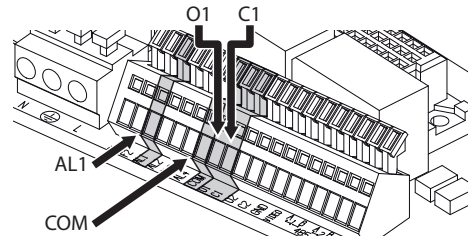

Fig. 118 Standard version.

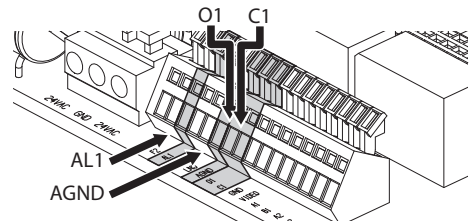

Fig. 119 Version with LED illuminators.

i For further information refer to the relative chapter (10.1.10.3 Washer Menu, page 51).

11.2 Wall mount bracket

Wall bracket with internal cable channel.

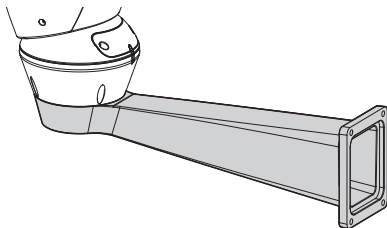

Fig. 120

11.3 Parapet bracket

Parapet bracket with internal cable channel.

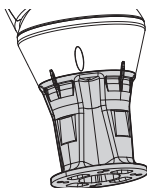

Fig. 121

11.4 Power supply with illuminator control

Weather-proof box with power supply and control of the illuminators.

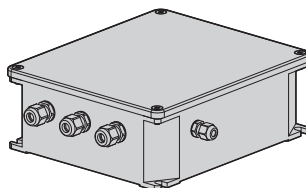

Fig. 122 Version of the standard box.

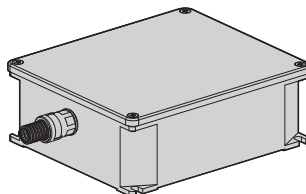

Fig. 123 Version of the UL certified box.



For further information refer to the relative chapter (8.5.3 Connection of the alarm inputs, of the twilight switch and of the relays, page 26).

12 Instructions for normal operation

12.1 Visualizing the state of the pan & tilt

During normal operation the pan & tilt displays on screen, at user's choice, the data organized as illustrated. The visualization can be enabled or disabled (10.1.9 Display Menu, page 49).

ID 1: Receiver's address;

ZONE 1: Name of the area where one is currently located;

MASK 1: Name of the mask displayed;

ALARM 1: Text regarding the last active alarm;

Preset 001 go to: Commands received via serial;

E1: PATROL CONFIGURATION: Display of the errors detected during system operation;

PAN/TILT/Z/F/I: Current position of PAN, TILT, ZOOM, FOCUS and IRIS;

PRESET 001: Name of selected active preset.

```

ID 1

ZONE 1
MASK 1
ALARM1
Preset 001 go to

E1: PATROL CONFIGURATION
PAN : +000.00
TILT: +000.00
Z:000.0 F:000.0 I:000.0
PRESET 001
  
```

Fig. 124

12.2 Saving a Preset

The current position can be saved using the control device being used (for additional information refer to the manual of the device being used).

12.3 Restore a Preset position (Scan)

Using the control device it is possible to recall a previously saved Preset position (for additional information refer to the manual of the device being used).

12.4 Recalling the Home position

Using the control device it is possible to recall a previously saved Home (Scan n.1) position (for further information refer to the manual of the control device in use).

12.5 Patrol enabling

The Patrol function loads the saved Presets in sequence.

To activate/deactivate this function, refer to the manual of the control device used or to the relative chapter (12.11 Special controls, page 56).

To deactivate this function, move the joystick or restore a different type of movement.

Refer to the relative chapter for the configuration of this function (10.1.8.6 Patrol Menu, page 48).

12.6 Autopan enabling

The Autopan function loads the 2 saved Presets in a continuous manner.

To activate/deactivate this function, refer to the manual of the control device used or to the relative chapter (12.11 Special controls, page 56).

To deactivate this function, move the joystick or restore a different type of movement.

Refer to the relative chapter for the configuration of this function (10.1.8.7 Autopan Menu, page 48).

12.7 Enabling the wiper (Wiper)



Do not use the wiper when the outside temperature is below 0°C or in case of ice.

To activate/deactivate this function, refer to the manual of the control device used or to the relative chapter (12.11 Special controls, page 56).



If it is left on, the wiper automatically disables itself.

12.8 Enabling the washer (Washer)

When a control is provided, the Pan & Tilt is positioned with the window in front of the nozzle.. The pump and wiper are activated for a set period of time. At the end of the operation the P&T returns to its initial position.

To activate/deactivate this function, refer to the manual of the control device used or to the relative chapter (12.11 Special controls, page 56).

To activate special configurations, refer to the relative chapter (12.12 Special configurations, page 57).

For models with washer complete with level sensor, can also display a video message when the level of the liquid inside the tank is too low (only if using a high prevalence pump).

12.9 Enabling the LED illuminator

If the system is not provided with a dusk switch, you can activate/deactivate the LED illuminator with the specific control (12.11 Special controls, page 56).

12.10 Unit Reboot

Using the control device it is possible to reboot the unit (for further information refer to the manual of the control device in use).

For further information refer to the relative chapter (12.11 Special controls, page 56).

12.11 Special controls

SPECIAL CONTROLS						
Action	Control					
	Protocol					
	AMERICAN DYNAMICS	ERNITEC	PANASONIC	PELCO D	VIDEOTEC MACRO	VISTA
Wiper Start	Save Preset 85	Save Preset 85	Save Preset 85	Save Preset 85	Save Preset 85	Save Preset 85
	Aux 3 ON	Aux 3 ON	Save Preset 54	Aux 3 ON	Aux 3 ON	Aux 3 ON
					Wip+	
Wiper Stop	Save Preset 86	Save Preset 86	Save Preset 86	Save Preset 86	Save Preset 86	Save Preset 86
	Aux 3 OFF	Aux 3 OFF	Save Preset 55	Aux 3 OFF	Aux 3 OFF	Aux 3 OFF
					Wip-	
Washer Start	Save Preset 87	Save Preset 87	Save Preset 87	Save Preset 87	Save Preset 87	Save Preset 87
	Aux 4 ON	Aux 4 ON	Save Preset 56	Aux 4 ON	Aux 4 ON	Aux 4 ON
					Was+	
Night Mode On	Save Preset 88	Save Preset 88	Save Preset 88	Save Preset 88	Save Preset 88	Save Preset 88
			Save Preset 57			
Night Mode Off	Save Preset 89	Save Preset 89	Save Preset 89	Save Preset 89	Save Preset 89	Save Preset 89
			Save Preset 58			
Patrol Stop	Save Preset 92	Save Preset 92	Save Preset 92	Save Preset 92	Save Preset 92	Save Preset 92
	Joystick	Joystick	Joystick	Joystick	Joystick	Joystick
			Save Preset 59		Pat-	
Patrol Start	Save Preset 93	Save Preset 93	Save Preset 93	Save Preset 93	Save Preset 93	Save Preset 93
	Run pattern 1	Run patrol	Save Preset 60	Pattern	Pat+	Run Patrol
Reboot the device	Save Preset 94	Save Preset 94	Save Preset 94	Save Preset 94	Save Preset 94	Save Preset 94
	Faster+ Zoom out+ Focus far+ Iris open		Save Preset 61		Ini+	
Enabling OSM	Save Preset 95	Save Preset 95	Save Preset 95	Save Preset 95	Save Preset 95	Save Preset 95
	Iris open+ Focus+ Zoom out		Save Preset 46		Men+	
Autopan Stop	Save Preset 96	Save Preset 96	Save Preset 96	Save Preset 96	Save Preset 96	Save Preset 96
	Joystick	Joystick	Joystick	Joystick	Joystick	Joystick
			Save Preset 62		Apa-	
Autopan Start	Save Preset 99	Save Preset 99	Save Preset 99	Save Preset 99	Save Preset 99	Save Preset 99
	Run Pattern 2	Run Autopan	Save Preset 63	Pattern 1	Apa+	Run Autopan

Tab. 18

12.12 Special configurations

SPECIAL CONFIGURATIONS					
Configuration	Protocol				
	AMERICAN DYNAMICS	PANASONIC	PELCO D	VIDEOTEC MACRO	VISTA
Washer Configuration 1 (short wash)	Save Preset 72	Save Preset 72	Save Preset 72	Save Preset 72	Save Preset 72
Washer Configuration 2 (long wash)	Save Preset 73	Save Preset 73	Save Preset 73	Save Preset 73	Save Preset 73

Tab. 19

13 Maintenance



Maintenance must be carried out by personnel trained to operate on electrical circuits.

13.1 Fuses replacement



Maintenance must be performed with the power supply disconnected and the circuit-breaker open.

If necessary, replace the fuses illustrated in figure (8.3 Connector board description, page 21).

FUSES REPLACEMENT		
Voltage	Fuse F1	Fuse F2
24Vac, 50/60Hz	T 4A L 250V 5x20	T 6.3A H 250V 5x20 (standard version) T 8A H 250V 5x20 (version with LED illuminators)
120Vac, 50/60Hz	T 4A L 250V 5x20	T 4A H 250V 5x20
230Vac, 50/60Hz	T 4A L 250V 5x20	T 2A H 250V 5x20

Tab. 20

14 Cleaning

14.1 Window and plastic cover cleaning



Avoid ethyl alcohol, solvents, hydrogenated hydrocarbide, strong acid and alkali. Such products may irreparably damage the surface.

We recommend using a soft cloth with neutral soaps diluted with water or specific products to clean the glasses lenses.

14.2 Cleaning the germanium window



Cleaning the window take care not to scratch or damage the outer surface treated with carbon coating. Damage to this coating could also interfere with the transparency of the surface to infrared light.

Cleaning should be done with mild soap diluted with water.

15 Disposal of waste materials



This symbol mark and recycle system are applied only to EU countries and not applied to the countries in the other area of the world.

Your product is designed and manufactured with high quality materials and components which can be recycled and reused.

This symbol means that electrical and electronic equipment, at their end-of-life, should be disposed of separately from your household waste.

Please dispose of this equipment at your local Community waste collection or Recycling centre.

In the European Union there are separate collection systems for used electrical and electronic products.

16 Troubleshooting

Ask for assistance from skilled personnel if:

- The unit is damaged after being dropped;
- There is noticeable deterioration in performance of the unit.
- The unit does not work properly, even though all the instructions in this handbook have been followed.

PROBLEM **The product does not go on.**

CAUSE Wiring error, blown fuse.

SOLUTION Make sure the connections are correct. Check the continuity of the fuses and replace them with the indicated models should they fail.

PROBLEM **Under special zoom conditions, the housing or sunshield interfere with the image being shot (only for versions with motorised zoom lens).**

CAUSE The position of the camera or lens is too far back in relation to the window.

SOLUTION Adjust the position of the camera and lens.

PROBLEM **A blue display appears instead of the footage with the following indication: No Video Signal!!!.**

CAUSE Incorrect wiring of the camera or failed camera.

SOLUTION Make sure the connections are correct.

PROBLEM **During start-up, the Pan & Tilt remains blocked and displays a screen similar to that shown below:**

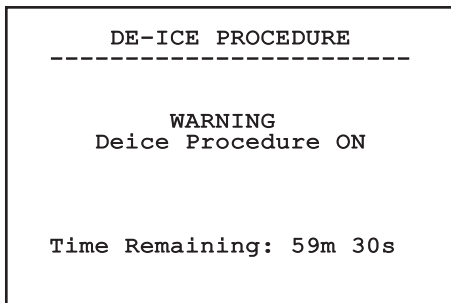

CAUSE Air temperature is very low.

SOLUTION Wait until the end of the pre-heating procedure. If the room temperature is too low the pan & tilt is blocked and shows the following screen:

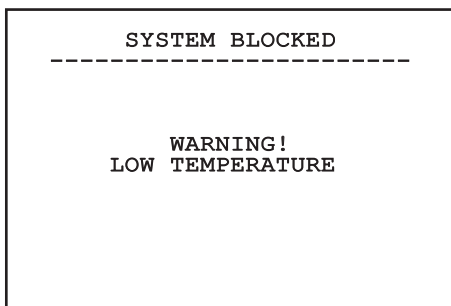

PROBLEM A display such as that shown below appears instead of the footage:

```

                INFO
-----
Device ID: 00001
Type      : Rs485 only Rx
Baud Rate: 19200-8N1
Protocol  : PELCO-D
Net Board: Fw05.01 Hw00
Mpp Board: Fw05.01 Hw00
Config.   : 001
P.C.      : UPT1SMSA005C
S.N.      : 00000000000000
Upgrade   : NET BOARD

```

CAUSE Programming dip-switch on.

SOLUTION Turn off the P&T. Lower the firmware update dip-switch lever (8.14.2 DIP1 configuration, page 34). Turn the unit on again.

PROBLEM **Error E1: PATROL CONFIGURATION.**

CAUSE The presets have not been saved.
The presets have not been enabled.

SOLUTION Save one or more presets (12.2 Saving a Preset, page 54). Update the Patrol configuration menu (10.1.8.6 Patrol Menu, page 48).
Enable presets (10.1.8.4 Preset Menu (Edit Preset), page 47).

PROBLEM **Error E2:AUTOPAN CONFIGURATION.**

CAUSE The two presets used as limits have not been saved.
The two presets used as limits have not been enabled.

SOLUTION Save two presets (12.2 Saving a Preset, page 54). Update the autopan configuration menu (10.1.8.7 Autopan Menu, page 48).
Enable presets (10.1.8.4 Preset Menu (Edit Preset), page 47).

PROBLEM **Error E3:WASHER DISABLED or error E4:WASHER PRST DISABLED.**

CAUSE Washing system not enabled.

SOLUTION Enable the washer system (10.1.10.3 Washer Menu, page 51).

PROBLEM **Error PRESET XXX NOT ENABLED.**

CAUSE Restore an unsaved preset
Restore a non-enabled preset

SOLUTION Save the preset using the relative control (12.2 Saving a Preset, page 54).
Enable preset (10.1.8.4 Preset Menu (Edit Preset), page 47).

17 Technical data

17.1 General

Constructed from aluminium and tecnopolymer
Epoxypolyester powder painting, RAL9002 colour
Top mount (OTT)
Electronic limit switches
Zero backlash
Max weight camera+lens: 7.6kg (17lb)
Optical sensors for absolute positioning feedback
Maximum number of presets: 250 (VIDEOTEC MACRO)
15 characters string for Area and Preset titling
Configuration through OSM
Addressable through DIP-switch up 255 units

17.2 Mechanical

Cable glands: 3xM16
Horizontal rotation: continuous
Vertical rotation: from +45° up to -20°
Horizontal speed (variable): from 0.02°/s up to 20°/s
Tilt speed (variable): from 0.02°/s up to 20°/s
Internal usable area: See drawings
Transmission through toothed belt
Accuracy of preset positions: 0.02°
Unit weight: 30kg (66lb)

17.3 Housing's window

Glass window
• Dimensions: 112mm (4.4in)x95mm (3.7in)
Germanium window
• Diameter: 85mm (3.3in) (external), 70mm (2.8in) (usable diameter)
• Thick: 2mm (0.07in)
• External scratch-resistant treatment: Hard Carbon Coating (DLC)
• Internal antireflection treatment
Spectral range: from 7.5µm up to 14µm
Medium transmittance (from 7.5µm up to 11.5µm): 94%
Medium transmittance (from 11.5µm up to 14µm): 90%
Transmittance of the germanium window

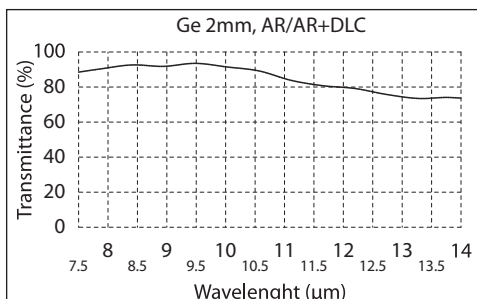

Fig. 125

17.4 Electrical

Power supply/Current consumption:
• 230Vac, 0.4A, 50/60Hz
• 24Vac, 4A (8A with LED illuminators), 50/60Hz
• 120Vac, 0.8A, 50/60Hz
Power consumption:
• 100W
• 150-190W max with LED illuminators in 24Vac
• 24W, P&T static, heating switched off
Camera power supply: 12Vdc, 800mA
Cables input section:
• 0.75mm ² (18AWG), 120Vac or 230Vac
• 1.5mm ² (16AWG), 24Vac
Cables signal section: from 0.14mm ² (26AWG) up to 0.5mm ² (20AWG)

17.5 Video

Video line: coaxial cable (1Vpp, 75Ohm)

17.6 Communications

RS-232 interface for firmware update

2-ports RS-485 for daisy chain configuration

17.7 Protocols

Configuration of telemetry protocol parameters via DIP-switch

Protocols supported:

- AMERICAN DYNAMICS
- PANASONIC
- PELCO D
- VIDEOTEC MACRO
- VISTA

17.8 I/O interface

Alarm input:

- 4 (standard version)
- 2 (version with LED illuminators)
- Control voltage: From 10Vdc up to 35Vdc

Dry contacts:

- 2 (standard version)
- 1 (version with LED illuminators)
- Applicable voltage: 50Vdc max or 30Vac@1A

17.9 Lenses

Power supply: From 6Vdc a 15Vdc, 200mA max

Control: Polarity inversion and common wire

17.10 Environment

Indoor/Outdoor

Operating temperature (with heater): From -10° (14°F)
up to +60°C (140°F)

17.11 Certifications

Electrical safety (CE): EN60950-1

Electromagnetic compatibility (CE): EN50130-4,
EN55022 (Class B), FCC Part 15 (Class B)

Outdoor installation (CE): EN60950-22

IP protection degree: EN60529 (IP66)

Salty fog resistance: EN50130-5, EN60068-2-52

EAC certification

18 Technical drawings

i The dimensions of the drawings are in millimetres.

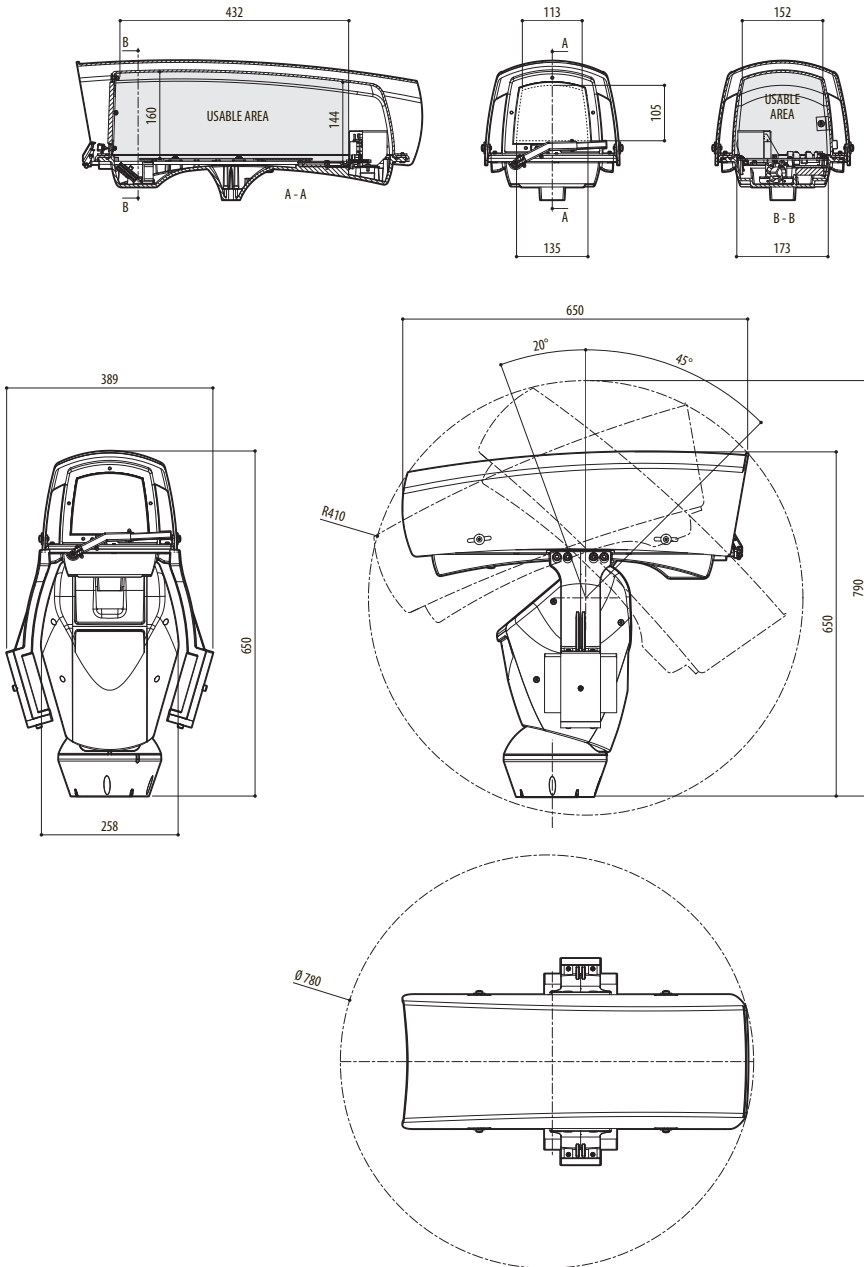

Fig. 126 ULISSE MAXI, standard version.

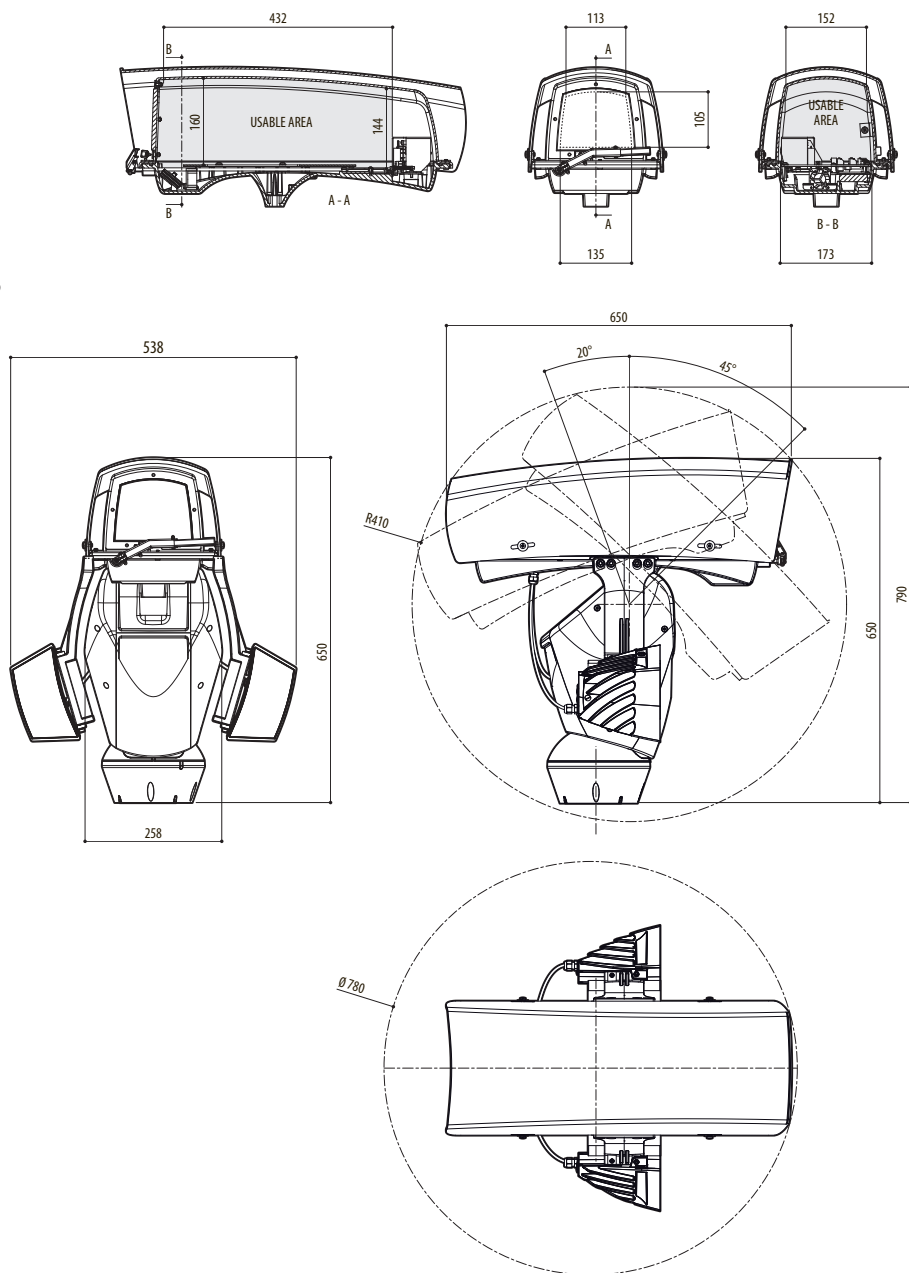

Fig. 127 ULISSE MAXI, pre-arranged version for two LED illuminators installation.

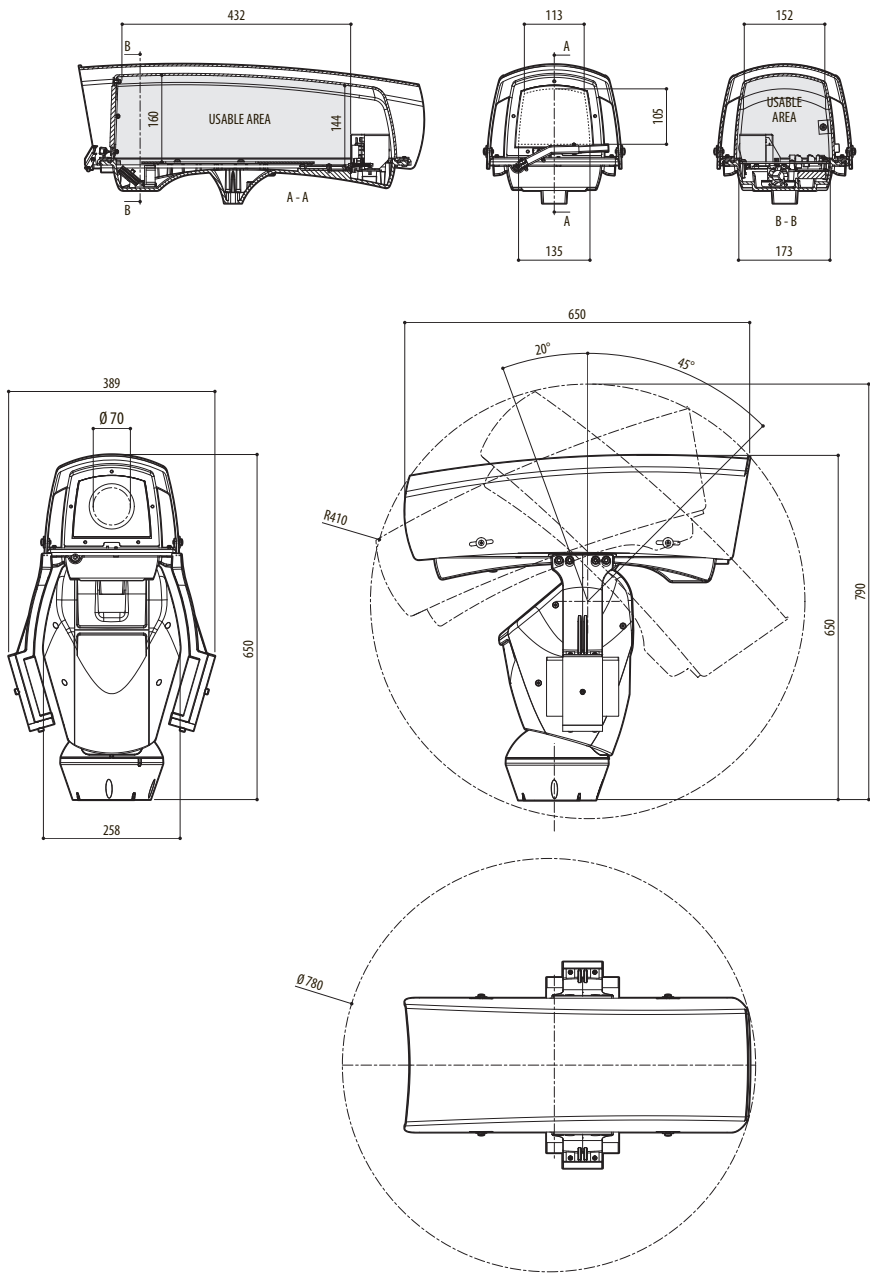

Fig. 128 ULISSE MAXI, version for thermal cameras.

A Appendix - Address table



When the switch rocker is up it represents the value 1 (ON). When the dip-switch rocker is down it represents the value 0 (OFF).

All possible combinations are shown below.

ADDRESS CONFIGURATION (DIP 3)								
SW 8	SW 7	SW 6	SW 5	SW 4	SW 3	SW 2	SW 1	Address
OFF	OFF	OFF	OFF	OFF	OFF	OFF	OFF	Address not enabled
OFF	OFF	OFF	OFF	OFF	OFF	OFF	ON	Address 1
OFF	OFF	OFF	OFF	OFF	OFF	ON	OFF	Address 2
OFF	OFF	OFF	OFF	OFF	OFF	ON	ON	Address 3
OFF	OFF	OFF	OFF	OFF	ON	OFF	OFF	Address 4
OFF	OFF	OFF	OFF	OFF	ON	OFF	ON	Address 5
OFF	OFF	OFF	OFF	OFF	ON	ON	OFF	Address 6
OFF	OFF	OFF	OFF	OFF	ON	ON	ON	Address 7
OFF	OFF	OFF	OFF	ON	OFF	OFF	OFF	Address 8
OFF	OFF	OFF	OFF	ON	OFF	OFF	ON	Address 9
OFF	OFF	OFF	OFF	ON	OFF	ON	OFF	Address 10
OFF	OFF	OFF	OFF	ON	ON	OFF	OFF	Address 11
OFF	OFF	OFF	OFF	ON	ON	ON	OFF	Address 12
OFF	OFF	OFF	OFF	ON	ON	OFF	ON	Address 13
OFF	OFF	OFF	OFF	ON	ON	ON	OFF	Address 14
OFF	OFF	OFF	OFF	ON	ON	ON	ON	Address 15
OFF	OFF	OFF	ON	OFF	OFF	OFF	OFF	Address 16
OFF	OFF	OFF	ON	OFF	OFF	OFF	ON	Address 17
OFF	OFF	OFF	ON	OFF	OFF	ON	OFF	Address 18
OFF	OFF	OFF	ON	OFF	OFF	ON	ON	Address 19
OFF	OFF	OFF	ON	OFF	ON	OFF	OFF	Address 20
OFF	OFF	OFF	ON	OFF	ON	OFF	ON	Address 21
OFF	OFF	OFF	ON	OFF	ON	ON	OFF	Address 22
OFF	OFF	OFF	ON	OFF	ON	ON	ON	Address 23
OFF	OFF	OFF	ON	ON	OFF	OFF	OFF	Address 24
OFF	OFF	OFF	ON	ON	OFF	OFF	ON	Address 25
OFF	OFF	OFF	ON	ON	OFF	ON	OFF	Address 26
OFF	OFF	OFF	ON	ON	OFF	ON	ON	Address 27
OFF	OFF	OFF	ON	ON	ON	OFF	OFF	Address 28
OFF	OFF	OFF	ON	ON	ON	OFF	ON	Address 29
OFF	OFF	OFF	ON	ON	ON	ON	OFF	Address 30
OFF	OFF	OFF	ON	ON	ON	ON	ON	Address 31
OFF	OFF	ON	OFF	OFF	OFF	OFF	OFF	Address 32
OFF	OFF	ON	OFF	OFF	OFF	OFF	ON	Address 33
OFF	OFF	ON	OFF	OFF	OFF	ON	OFF	Address 34
OFF	OFF	ON	OFF	OFF	OFF	ON	ON	Address 35
OFF	OFF	ON	OFF	OFF	ON	OFF	OFF	Address 36
OFF	OFF	ON	OFF	OFF	ON	OFF	ON	Address 37
OFF	OFF	ON	OFF	OFF	ON	ON	OFF	Address 38

ADDRESS CONFIGURATION (DIP 3)								
SW 8	SW 7	SW 6	SW 5	SW 4	SW 3	SW 2	SW 1	Address
OFF	OFF	ON	OFF	OFF	ON	ON	ON	Address 39
OFF	OFF	ON	OFF	ON	OFF	OFF	OFF	Address 40
OFF	OFF	ON	OFF	ON	OFF	OFF	ON	Address 41
OFF	OFF	ON	OFF	ON	OFF	ON	OFF	Address 42
OFF	OFF	ON	OFF	ON	OFF	ON	ON	Address 43
OFF	OFF	ON	OFF	ON	ON	OFF	OFF	Address 44
OFF	OFF	ON	OFF	ON	ON	OFF	ON	Address 45
OFF	OFF	ON	OFF	ON	ON	ON	OFF	Address 46
OFF	OFF	ON	OFF	ON	ON	ON	ON	Address 47
OFF	OFF	ON	ON	OFF	OFF	OFF	OFF	Address 48
OFF	OFF	ON	ON	OFF	OFF	OFF	ON	Address 49
OFF	OFF	ON	ON	OFF	OFF	ON	OFF	Address 50
OFF	OFF	ON	ON	OFF	OFF	ON	ON	Address 51
OFF	OFF	ON	ON	OFF	ON	OFF	OFF	Address 52
OFF	OFF	ON	ON	OFF	ON	OFF	ON	Address 53
OFF	OFF	ON	ON	OFF	ON	ON	OFF	Address 54
OFF	OFF	ON	ON	OFF	ON	ON	ON	Address 55
OFF	OFF	ON	ON	ON	OFF	OFF	OFF	Address 56
OFF	OFF	ON	ON	ON	OFF	OFF	ON	Address 57
OFF	OFF	ON	ON	ON	OFF	ON	OFF	Address 58
OFF	OFF	ON	ON	ON	OFF	ON	ON	Address 59
OFF	OFF	ON	ON	ON	ON	OFF	OFF	Address 60
OFF	OFF	ON	ON	ON	ON	OFF	ON	Address 61
OFF	OFF	ON	ON	ON	ON	ON	OFF	Address 62
OFF	OFF	ON	ON	ON	ON	ON	ON	Address 63
OFF	ON	OFF	OFF	OFF	OFF	OFF	OFF	Address 64
OFF	ON	OFF	OFF	OFF	OFF	OFF	ON	Address 65
OFF	ON	OFF	OFF	OFF	OFF	ON	OFF	Address 66
OFF	ON	OFF	OFF	OFF	OFF	ON	ON	Address 67
OFF	ON	OFF	OFF	OFF	ON	OFF	OFF	Address 68
OFF	ON	OFF	OFF	OFF	ON	OFF	ON	Address 69
OFF	ON	OFF	OFF	OFF	ON	ON	OFF	Address 70
OFF	ON	OFF	OFF	OFF	ON	ON	ON	Address 71
OFF	ON	OFF	OFF	ON	OFF	OFF	OFF	Address 72
OFF	ON	OFF	OFF	ON	OFF	OFF	ON	Address 73
OFF	ON	OFF	OFF	ON	OFF	ON	OFF	Address 74
OFF	ON	OFF	OFF	ON	OFF	ON	ON	Address 75
OFF	ON	OFF	OFF	ON	ON	OFF	OFF	Address 76
OFF	ON	OFF	OFF	ON	ON	OFF	ON	Address 77
OFF	ON	OFF	OFF	ON	ON	ON	OFF	Address 78
OFF	ON	OFF	OFF	ON	ON	ON	ON	Address 79
OFF	ON	OFF	ON	OFF	OFF	OFF	OFF	Address 80
OFF	ON	OFF	ON	OFF	OFF	OFF	ON	Address 81
OFF	ON	OFF	ON	OFF	OFF	ON	OFF	Address 82

ADDRESS CONFIGURATION (DIP 3)

SW 8	SW 7	SW 6	SW 5	SW 4	SW 3	SW 2	SW 1	Address
OFF	ON	OFF	ON	OFF	OFF	ON	ON	Address 83
OFF	ON	OFF	ON	OFF	ON	OFF	OFF	Address 84
OFF	ON	OFF	ON	OFF	ON	OFF	ON	Address 85
OFF	ON	OFF	ON	OFF	ON	ON	OFF	Address 86
OFF	ON	OFF	ON	OFF	ON	ON	ON	Address 87
OFF	ON	OFF	ON	ON	OFF	OFF	OFF	Address 88
OFF	ON	OFF	ON	ON	OFF	OFF	ON	Address 89
OFF	ON	OFF	ON	ON	OFF	ON	OFF	Address 90
OFF	ON	OFF	ON	ON	OFF	ON	ON	Address 91
OFF	ON	OFF	ON	ON	ON	OFF	OFF	Address 92
OFF	ON	OFF	ON	ON	ON	OFF	ON	Address 93
OFF	ON	OFF	ON	ON	ON	ON	OFF	Address 94
OFF	ON	OFF	ON	ON	ON	ON	ON	Address 95
OFF	ON	ON	OFF	OFF	OFF	OFF	OFF	Address 96
OFF	ON	ON	OFF	OFF	OFF	OFF	ON	Address 97
OFF	ON	ON	OFF	OFF	OFF	ON	OFF	Address 98
OFF	ON	ON	OFF	OFF	OFF	ON	ON	Address 99
OFF	ON	ON	OFF	OFF	ON	OFF	OFF	Address 100
OFF	ON	ON	OFF	OFF	ON	OFF	ON	Address 101
OFF	ON	ON	OFF	OFF	ON	ON	OFF	Address 102
OFF	ON	ON	OFF	OFF	ON	ON	ON	Address 103
OFF	ON	ON	OFF	ON	OFF	OFF	OFF	Address 104
OFF	ON	ON	OFF	ON	OFF	OFF	ON	Address 105
OFF	ON	ON	OFF	ON	OFF	ON	OFF	Address 106
OFF	ON	ON	OFF	ON	OFF	ON	ON	Address 107
OFF	ON	ON	OFF	ON	ON	OFF	OFF	Address 108
OFF	ON	ON	OFF	ON	ON	OFF	ON	Address 109
OFF	ON	ON	OFF	ON	ON	ON	OFF	Address 110
OFF	ON	ON	OFF	ON	ON	ON	ON	Address 111
OFF	ON	ON	ON	OFF	OFF	OFF	OFF	Address 112
OFF	ON	ON	ON	OFF	OFF	OFF	ON	Address 113
OFF	ON	ON	ON	OFF	OFF	ON	OFF	Address 114
OFF	ON	ON	ON	OFF	OFF	ON	ON	Address 115
OFF	ON	ON	ON	OFF	ON	OFF	OFF	Address 116
OFF	ON	ON	ON	OFF	ON	OFF	ON	Address 117
OFF	ON	ON	ON	OFF	ON	ON	OFF	Address 118
OFF	ON	ON	ON	OFF	ON	ON	ON	Address 119
OFF	ON	ON	ON	ON	OFF	OFF	OFF	Address 120
OFF	ON	ON	ON	ON	OFF	OFF	ON	Address 121
OFF	ON	ON	ON	ON	OFF	ON	OFF	Address 122
OFF	ON	ON	ON	ON	OFF	ON	ON	Address 123
OFF	ON	ON	ON	ON	ON	OFF	OFF	Address 124
OFF	ON	ON	ON	ON	ON	OFF	ON	Address 125
OFF	ON	ON	ON	ON	ON	ON	OFF	Address 126

ADDRESS CONFIGURATION (DIP 3)

SW 8	SW 7	SW 6	SW 5	SW 4	SW 3	SW 2	SW 1	Address
OFF	ON	ON	ON	ON	ON	ON	ON	Address 127
ON	OFF	OFF	OFF	OFF	OFF	OFF	OFF	Address 128
ON	OFF	OFF	OFF	OFF	OFF	OFF	ON	Address 129
ON	OFF	OFF	OFF	OFF	OFF	ON	OFF	Address 130
ON	OFF	OFF	OFF	OFF	OFF	ON	ON	Address 131
ON	OFF	OFF	OFF	OFF	ON	OFF	OFF	Address 132
ON	OFF	OFF	OFF	OFF	ON	OFF	ON	Address 133
ON	OFF	OFF	OFF	OFF	ON	ON	OFF	Address 134
ON	OFF	OFF	OFF	OFF	ON	ON	ON	Address 135
ON	OFF	OFF	OFF	ON	OFF	OFF	OFF	Address 136
ON	OFF	OFF	OFF	ON	OFF	OFF	ON	Address 137
ON	OFF	OFF	OFF	ON	OFF	ON	OFF	Address 138
ON	OFF	OFF	OFF	ON	OFF	ON	ON	Address 139
ON	OFF	OFF	OFF	ON	ON	OFF	OFF	Address 140
ON	OFF	OFF	OFF	ON	ON	OFF	ON	Address 141
ON	OFF	OFF	OFF	ON	ON	ON	OFF	Address 142
ON	OFF	OFF	OFF	ON	ON	ON	ON	Address 143
ON	OFF	OFF	ON	OFF	OFF	OFF	OFF	Address 144
ON	OFF	OFF	ON	OFF	OFF	OFF	ON	Address 145
ON	OFF	OFF	ON	OFF	OFF	ON	OFF	Address 146
ON	OFF	OFF	ON	OFF	OFF	ON	ON	Address 147
ON	OFF	OFF	ON	OFF	ON	OFF	OFF	Address 148
ON	OFF	OFF	ON	OFF	ON	OFF	ON	Address 149
ON	OFF	OFF	ON	OFF	ON	ON	OFF	Address 150
ON	OFF	OFF	ON	OFF	ON	ON	ON	Address 151
ON	OFF	OFF	ON	ON	OFF	OFF	OFF	Address 152
ON	OFF	OFF	ON	ON	OFF	OFF	ON	Address 153
ON	OFF	OFF	ON	ON	OFF	ON	OFF	Address 154
ON	OFF	OFF	ON	ON	OFF	ON	ON	Address 155
ON	OFF	OFF	ON	ON	ON	OFF	OFF	Address 156
ON	OFF	OFF	ON	ON	ON	OFF	ON	Address 157
ON	OFF	OFF	ON	ON	ON	ON	OFF	Address 158
ON	OFF	OFF	ON	ON	ON	ON	ON	Address 159
ON	OFF	ON	OFF	OFF	OFF	OFF	OFF	Address 160
ON	OFF	ON	OFF	OFF	OFF	OFF	ON	Address 161
ON	OFF	ON	OFF	OFF	OFF	ON	OFF	Address 162
ON	OFF	ON	OFF	OFF	OFF	ON	ON	Address 163
ON	OFF	ON	OFF	OFF	ON	OFF	OFF	Address 164
ON	OFF	ON	OFF	OFF	ON	OFF	ON	Address 165
ON	OFF	ON	OFF	OFF	ON	ON	OFF	Address 166
ON	OFF	ON	OFF	OFF	ON	ON	ON	Address 167
ON	OFF	ON	OFF	ON	OFF	OFF	OFF	Address 168
ON	OFF	ON	OFF	ON	OFF	OFF	ON	Address 169
ON	OFF	ON	OFF	ON	OFF	ON	OFF	Address 170

ADDRESS CONFIGURATION (DIP 3)

SW 8	SW 7	SW 6	SW 5	SW 4	SW 3	SW 2	SW 1	Address
ON	OFF	ON	OFF	ON	OFF	ON	ON	Address 171
ON	OFF	ON	OFF	ON	ON	OFF	OFF	Address 172
ON	OFF	ON	OFF	ON	ON	OFF	ON	Address 173
ON	OFF	ON	OFF	ON	ON	ON	OFF	Address 174
ON	OFF	ON	OFF	ON	ON	ON	ON	Address 175
ON	OFF	ON	ON	OFF	OFF	OFF	OFF	Address 176
ON	OFF	ON	ON	OFF	OFF	OFF	ON	Address 177
ON	OFF	ON	ON	OFF	OFF	ON	OFF	Address 178
ON	OFF	ON	ON	OFF	OFF	ON	ON	Address 179
ON	OFF	ON	ON	OFF	ON	OFF	OFF	Address 180
ON	OFF	ON	ON	OFF	ON	OFF	ON	Address 181
ON	OFF	ON	ON	OFF	ON	ON	OFF	Address 182
ON	OFF	ON	ON	OFF	ON	ON	ON	Address 183
ON	OFF	ON	ON	ON	OFF	OFF	OFF	Address 184
ON	OFF	ON	ON	ON	OFF	OFF	ON	Address 185
ON	OFF	ON	ON	ON	OFF	ON	OFF	Address 186
ON	OFF	ON	ON	ON	OFF	ON	ON	Address 187
ON	OFF	ON	ON	ON	ON	OFF	OFF	Address 188
ON	OFF	ON	ON	ON	ON	OFF	ON	Address 189
ON	OFF	ON	ON	ON	ON	ON	OFF	Address 190
ON	OFF	ON	ON	ON	ON	ON	ON	Address 191
ON	ON	OFF	OFF	OFF	OFF	OFF	OFF	Address 192
ON	ON	OFF	OFF	OFF	OFF	OFF	ON	Address 193
ON	ON	OFF	OFF	OFF	OFF	ON	OFF	Address 194
ON	ON	OFF	OFF	OFF	OFF	ON	ON	Address 195
ON	ON	OFF	OFF	OFF	ON	OFF	OFF	Address 196
ON	ON	OFF	OFF	OFF	ON	OFF	ON	Address 197
ON	ON	OFF	OFF	OFF	ON	ON	OFF	Address 198
ON	ON	OFF	OFF	OFF	ON	ON	ON	Address 199
ON	ON	OFF	OFF	ON	OFF	OFF	OFF	Address 200
ON	ON	OFF	OFF	ON	OFF	OFF	ON	Address 201
ON	ON	OFF	OFF	ON	OFF	ON	OFF	Address 202
ON	ON	OFF	OFF	ON	OFF	ON	ON	Address 203
ON	ON	OFF	OFF	ON	ON	OFF	OFF	Address 204
ON	ON	OFF	OFF	ON	ON	OFF	ON	Address 205
ON	ON	OFF	OFF	ON	ON	ON	OFF	Address 206
ON	ON	OFF	OFF	ON	ON	ON	ON	Address 207
ON	ON	OFF	ON	OFF	OFF	OFF	OFF	Address 208
ON	ON	OFF	ON	OFF	OFF	OFF	ON	Address 209
ON	ON	OFF	ON	OFF	OFF	ON	OFF	Address 210
ON	ON	OFF	ON	OFF	OFF	ON	ON	Address 211
ON	ON	OFF	ON	OFF	ON	OFF	OFF	Address 212
ON	ON	OFF	ON	OFF	ON	OFF	ON	Address 213
ON	ON	OFF	ON	OFF	ON	ON	OFF	Address 214

ADDRESS CONFIGURATION (DIP 3)								
SW 8	SW 7	SW 6	SW 5	SW 4	SW 3	SW 2	SW 1	Address
ON	ON	OFF	ON	OFF	ON	ON	ON	Address 215
ON	ON	OFF	ON	ON	OFF	OFF	OFF	Address 216
ON	ON	OFF	ON	ON	OFF	OFF	ON	Address 217
ON	ON	OFF	ON	ON	OFF	ON	OFF	Address 218
ON	ON	OFF	ON	ON	OFF	ON	ON	Address 219
ON	ON	OFF	ON	ON	ON	OFF	OFF	Address 220
ON	ON	OFF	ON	ON	ON	OFF	ON	Address 221
ON	ON	OFF	ON	ON	ON	ON	OFF	Address 222
ON	ON	OFF	ON	ON	ON	ON	ON	Address 223
ON	ON	ON	OFF	OFF	OFF	OFF	OFF	Address 224
ON	ON	ON	OFF	OFF	OFF	OFF	ON	Address 225
ON	ON	ON	OFF	OFF	OFF	ON	OFF	Address 226
ON	ON	ON	OFF	OFF	OFF	ON	ON	Address 227
ON	ON	ON	OFF	OFF	ON	OFF	OFF	Address 228
ON	ON	ON	OFF	OFF	ON	OFF	ON	Address 229
ON	ON	ON	OFF	OFF	ON	ON	OFF	Address 230
ON	ON	ON	OFF	OFF	ON	ON	ON	Address 231
ON	ON	ON	OFF	ON	OFF	OFF	OFF	Address 232
ON	ON	ON	OFF	ON	OFF	OFF	ON	Address 233
ON	ON	ON	OFF	ON	OFF	ON	OFF	Address 234
ON	ON	ON	OFF	ON	OFF	ON	ON	Address 235
ON	ON	ON	OFF	ON	ON	OFF	OFF	Address 236
ON	ON	ON	OFF	ON	ON	OFF	ON	Address 237
ON	ON	ON	OFF	ON	ON	ON	OFF	Address 238
ON	ON	ON	OFF	ON	ON	ON	ON	Address 239
ON	ON	ON	ON	OFF	OFF	OFF	OFF	Address 240
ON	ON	ON	ON	OFF	OFF	OFF	ON	Address 241
ON	ON	ON	ON	OFF	OFF	ON	OFF	Address 242
ON	ON	ON	ON	OFF	OFF	ON	ON	Address 243
ON	ON	ON	ON	OFF	ON	OFF	OFF	Address 244
ON	ON	ON	ON	OFF	ON	OFF	ON	Address 245
ON	ON	ON	ON	OFF	ON	ON	OFF	Address 246
ON	ON	ON	ON	OFF	ON	ON	ON	Address 247
ON	ON	ON	ON	ON	OFF	OFF	OFF	Address 248
ON	ON	ON	ON	ON	OFF	OFF	ON	Address 249
ON	ON	ON	ON	ON	OFF	ON	OFF	Address 250
ON	ON	ON	ON	ON	OFF	ON	ON	Address 251
ON	ON	ON	ON	ON	ON	OFF	OFF	Address 252
ON	ON	ON	ON	ON	ON	OFF	ON	Address 253
ON	ON	ON	ON	ON	ON	ON	OFF	Address 254
ON	ON	ON	ON	ON	ON	ON	ON	Address 255

Tab. 21

Headquarters Italy Videotec S.p.A.

Via Friuli, 6 - I-36015 Schio (VI) - Italy

Tel. +39 0445 697411 - Fax +39 0445 697414

Email: info@videotec.com

Asia Pacific Videotec (HK) Ltd

Flat 8, 19/F. On Dak Industrial Building, No. 2-6 Wah Sing Street

Kwai Chung, New Territories - Hong Kong

Tel. +852 2333 0601 - Fax +852 2311 0026

Email: info.hk@videotec.com

France Videotec France SARL

Immeuble Le Montreal, 19bis Avenue du Québec, ZA de Courtaboeuf
91140 Villebon sur Yvette - France

Tel. +33 1 60491816 - Fax +33 1 69284736

Email: info.fr@videotec.com

Americas Videotec Security, Inc.

Gateway Industrial Park, 35 Gateway Drive, Suite 100
Plattsburgh, NY 12901 - U.S.A.

Tel. +1 518 825 0020 - Fax +1 518 825 0022

Email: info.usa@videotec.com - www.videotec.com



www.videotec.com

MNVCUPTMAXB_1511_EN



ULISSE MAXI

Unità PTZ per il monitoraggio dinamico di ampie aree outdoor

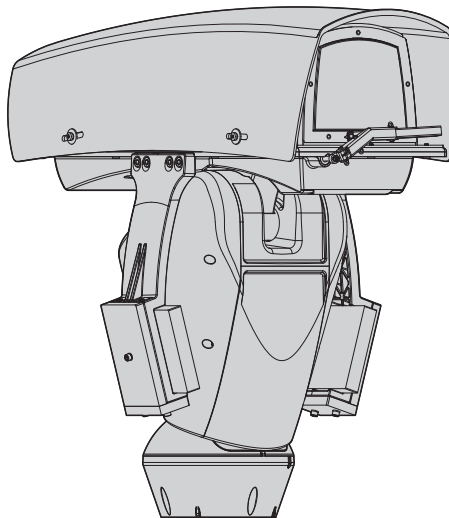

Sommario

1 Informazioni sul presente manuale	7
1.1 Convenzioni tipografiche	7
2 Note sul copyright e informazioni sui marchi commerciali.....	7
3 Norme di sicurezza	7
4 Identificazione	10
4.1 Descrizione e designazione del prodotto.....	10
4.2 Marcatura del prodotto	10
4.2.1 Controllo della marcatura.....	10
5 Versioni.....	11
5.1 Illuminatori a LED.....	11
5.2 Finestra in germanio.....	11
6 Preparazione del prodotto per l'utilizzo.....	12
6.1 Precauzioni di sicurezza prima dell'utilizzo.....	12
6.2 Disimballaggio.....	12
6.3 Contenuto	12
6.4 Smaltimento in sicurezza dei materiali di imballaggio.....	12
6.5 Lavoro preparatorio prima dell'installazione.....	13
6.5.1 Fissaggio del supporto	13
6.5.2 Passaggio cavi.....	13
7 Assemblaggio	14
7.1 Fissaggio del tettuccio.....	14
7.2 Apertura della custodia	14
7.3 Montaggio telecamera e ottiche motorizzate	14
7.3.1 Caratteristiche delle telecamere	14
7.3.2 Fissaggio dell'ottica e della telecamera alla slitta interna.....	15
7.3.3 Posizionamento del distanziale H-20 sulla slitta interna.....	16
7.3.4 Posizionamento della slitta interna.....	16
7.4 Descrizione della scheda della custodia.....	17
7.4.1 Collegamento della telecamera e dell'ottica motorizzata	17
7.4.2 Regolazione della tensione di alimentazione dei motori delle ottiche	18
8 Installazione.....	19
8.1 Collegamento dei cavi alla base.....	19
8.2 Fissaggio della base al supporto.....	20
8.3 Descrizione della scheda connettori	21
8.4 Collegamento della linea di alimentazione.....	22
8.4.1 Collegamento della linea di alimentazione in 24Vac.....	23
8.4.2 Collegamento della linea di alimentazione in 120Vac e 230Vac	23
8.5 Collegamento dei cavi di segnale.....	24
8.5.1 Collegamento del cavo video	24
8.5.2 Collegamento delle linee di telemetria	25
8.5.3 Collegamento degli ingressi di allarme, dell'interruttore crepuscolare e dei relè	26

8.6 Fissaggio del corpo superiore	27
8.7 Montaggio dei contrappesi	27
8.8 Montaggio degli illuminatori a LED	28
8.8.1 Rimozione dei contrappesi	28
8.8.2 Montaggio dell'illuminatore sulla staffa.....	28
8.9 Collegamento degli illuminatori a LED	29
8.10 Collegamento per la sincronizzazione della telecamera con gli illuminatori a LED	30
8.11 Sacchetto disidratante	30
8.12 Regolazione e modalità di attivazione degli illuminatori a LED.....	30
8.12.1 Descrizione dell'illuminatore a LED.....	30
8.12.2 Attivazione degli illuminatori a LED tramite un interruttore crepuscolare esterno.....	31
8.12.3 Attivazione degli illuminatori a LED tramite il sensore crepuscolare integrato	31
8.12.4 Regolazione della soglia di accensione degli illuminatori a LED	32
8.12.5 Regolazione della potenza degli illuminatori a LED.....	32
8.13 Fissaggio della spazzola del tergitricristallo.....	33
8.14 Configurazione hardware.....	34
8.14.1 Apertura dello sportellino di configurazione	34
8.14.2 Configurazione del DIP1.....	34
8.14.3 Configurazione del DIP2.....	34
8.14.4 Configurazione del DIP3.....	35
8.14.4.1 Configurazione dell'indirizzo	35
8.14.4.2 Configurazione delle linee di comunicazione seriali.....	35
8.14.5 Configurazione del DIP4.....	35
8.14.6 Esempi di installazione.....	36
8.14.6.1 Linea RS-485 RX	36
8.14.6.2 Linea RS-422 (RS-485-1 RX e RS-485-2 TX)	36
8.14.6.3 Linea RS-485-1 ricezione, linea RS-485-2 ripetizione	36
8.14.6.4 Linea RS-485 TX/RX bidirezionale	36
9 Accensione	37
9.1 Prima accensione.....	37
9.2 Lista dei controlli.....	37
10 Configurazione	38
10.1 Interfaccia OSM (On Screen Menu).....	38
10.1.1 Uso dell'OSM.....	38
10.1.1.1 Come usare il joystick	38
10.1.1.2 Come muoversi nei menù.....	39
10.1.1.3 Come modificare i parametri	39
10.1.1.4 Come modificare i campi numerici.....	40
10.1.1.5 Come modificare i testi	40
10.1.2 Configurazione tramite OSM	42
10.1.3 Menù Principale.....	42
10.1.4 Menù Scelta Lingua.....	42
10.1.5 Menù Parametri ZFI.....	42
10.1.5.1 Menù Titolazione Aree.....	43
10.1.5.2 Menù Mascheratura Aree	44
10.1.6 Menù Seriale Custodia	45
10.1.7 Menù Polarità	45
10.1.8 Menù Movimento	46
10.1.8.1 Menù Controllo Manuale.....	46

10.1.8.2 Menù Controllo Manuale (Limiti)	47
10.1.8.3 Menù Preset	47
10.1.8.4 Menù Preset (Modifica Preset).....	47
10.1.8.5 Menù Preset (Utilità Preset)	48
10.1.8.6 Menù Patrol	48
10.1.8.7 Menù Autopan	48
10.1.8.8 Menù Richiamo Movimenti	49
10.1.9 Menù Visualizzazioni	49
10.1.10 Menù I/O Digitali-Opzioni	49
10.1.10.1 Menù Allarmi	50
10.1.10.2 Menù Comunicazioni	50
10.1.10.3 Menù Impianto di Lavaggio.....	51
10.1.11 Menù Default	51
10.1.12 Menù Info	51
11 Accessori.....	52
11.1 Impianto di lavaggio	52
11.1.1 Collegamento dell'impianto di lavaggio	52
11.2 Supporto da parete	53
11.3 Supporto da parapetto	53
11.4 Alimentatore con controllo degli illuminatori	53
12 Istruzioni di funzionamento ordinario	54
12.1 Visualizzazione dello stato del brandeggio	54
12.2 Salvataggio di un Preset	54
12.3 Richiamo di una posizione di Preset (Scan).....	54
12.4 Richiamo della posizione di Home	54
12.5 Attivazione del Patrol.....	54
12.6 Attivazione dell'Autopan	55
12.7 Attivazione del tergicristallo (Wiper)	55
12.8 Attivazione dell'impianto di lavaggio (Washer)	55
12.9 Attivazione dell'illuminatore a LED.....	55
12.10 Reboot dell'unità.....	55
12.11 Comandi speciali.....	56
12.12 Configurazioni speciali.....	57
13 Manutenzione.....	58
13.1 Sostituzione dei fusibili.....	58
14 Pulizia	58
14.1 Pulizia del vetro e delle parti in plastica.....	58
14.2 Pulizia della finestra in germanio	58
15 Smaltimento dei rifiuti	58
16 Risoluzione dei problemi	59
17 Dati tecnici	61
17.1 Generale	61
17.2 Meccanica	61
17.3 Finestre per custodia.....	61
17.4 Elettrico.....	61

17.5 Video	62
17.6 Comunicazioni	62
17.7 Protocolli	62
17.8 Interfaccia I/O	62
17.9 Ottiche.....	62
17.10 Ambiente	62
17.11 Certificazioni.....	62
18 Disegni tecnici	63
A Appendice - Tabella degli indirizzi.....	66

1 Informazioni sul presente manuale

Prima di installare e utilizzare questa unità, leggere attentamente tutta la documentazione fornita. Tenere il manuale a portata di mano per consultazioni successive.

1.1 Convenzioni tipografiche



PERICOLO!
Pericolosità elevata.
Rischio di scosse elettriche. Prima di eseguire qualsiasi operazione assicurarsi di togliere tensione al prodotto, salvo diversa indicazione.



PERICOLO!
Superficie calda.
Evitare il contatto. Le superfici sono calde e potrebbero causare danni alla persona in caso di contatto.



PERICOLO!
Pericolo di natura meccanica.
Rischio di schiacciamento o cesoiamento.



ATTENZIONE!
Pericolosità media.
L'operazione è molto importante per il corretto funzionamento del sistema. Si prega di leggere attentamente la procedura indicata e di eseguirla secondo le modalità previste.



INFO
Descrizione delle caratteristiche del sistema.
Si consiglia di leggere attentamente per comprendere le fasi successive.

2 Note sul copyright e informazioni sui marchi commerciali

I nomi di prodotto o di aziende citati sono marchi commerciali o marchi commerciali registrati appartenenti alle rispettive società.

3 Norme di sicurezza



ATTENZIONE! L'impianto elettrico al quale è collegata l'unità deve essere dotato di un interruttore di protezione bipolare automatico da 20A max. Tale interruttore deve essere di tipo Listed. La distanza minima tra i contatti dell'interruttore di protezione deve essere di 3mm. L'interruttore deve essere provvisto di protezione contro la corrente di guasto verso terra (differenziale) e la sovracorrente (magnetotermico).



ATTENZIONE! Parti mobili pericolose. Non avvicinare dita e altre parti del corpo.



ATTENZIONE! L'installazione e la manutenzione del dispositivo deve essere eseguita solo da personale tecnico specializzato.



ATTENZIONE! Per assicurare la protezione contro il rischio di incendio, sostituire i fusibili con lo stesso tipo e valore. I fusibili devono essere sostituiti solo da personale qualificato.



ATTENZIONE! L'installazione è di tipo TNV-1. Non collegare a circuiti SELV.



ATTENZIONE! Per ridurre il rischio di incendio usare solamente cavi certificati UL Listed o CSA aventi sezioni maggiori o uguali a 0.14mm² (26AWG).

- Il produttore declina ogni responsabilità per eventuali danni derivanti da un uso improprio delle apparecchiature menzionate in questo manuale. Si riserva inoltre il diritto di modificarne il contenuto senza preavviso. Ogni cura è stata posta nella raccolta e nella verifica della documentazione contenuta in questo manuale. Il produttore, tuttavia, non può assumersi alcuna responsabilità derivante dall'utilizzo della stessa. Lo stesso dicasi per ogni persona o società coinvolta nella creazione e nella produzione di questo manuale.

- Prima di eseguire qualsiasi operazione assicurarsi di togliere tensione al prodotto.
- Non utilizzare cavi con segni di usura o invecchiamento.
- Non effettuare per nessun motivo alterazioni o collegamenti non previsti in questo manuale. L'uso di apparecchi non idonei può portare a gravi pericoli per la sicurezza del personale e dell'impianto.
- Utilizzare solo parti di ricambio originali. Pezzi di ricambio non originali potrebbero causare incendi, scariche elettriche o altri pericoli.
- Prima di procedere con l'installazione, controllare che il materiale fornito corrisponda alle specifiche richieste esaminando le etichette di marcatura (4.2 Marcatura del prodotto, pagina 10).
- La categoria di installazione (detta anche categoria di sovratensione) specifica i livelli della tensione transitoria di rete alla quale l'apparato è soggetto. La categoria dipende dal luogo di installazione e dalla presenza di dispositivi di protezione contro le sovratensioni. Un dispositivo per ambienti industriali, connesso ai rami principali dell'impianto di alimentazione è soggetto alla categoria di installazione III. Se questo è il caso, è richiesta una riduzione alla categoria II. Ciò può essere ottenuto utilizzando un trasformatore di isolamento con schermatura connessa a terra tra il primario ed il secondario, o tramite l'impiego di dispositivi di protezione contro le sovratensioni (SPD), UL listed, connessi tra la fase ed il neutro e tra il neutro e terra. I dispositivi SPD UL listed, dovranno essere predisposti per limitare sovratensioni transitorie in modo ripetitivo e per le seguenti condizioni nominali di funzionamento: Tipo 2 (Dispositivi SPD connessi permanentemente alla rete di alimentazione, per installazioni dal lato del carico del dispositivo di servizio); Corrente nominale di scarica (In) 20kA minimi. Si possono utilizzare ad esempio: FERRAZ SHAWMUT, ST23401PG-CN, ST2405PG-CN specificati per 120Vac/240Vac, (In=20kA). La distanza massima tra l'installazione e la riduzione è di 5m.
- Questo dispositivo è stato progettato per essere fissato e collegato in maniera permanente su un edificio o su una struttura adeguata. Il dispositivo deve essere fissato e collegato in maniera permanente prima di effettuare qualsiasi operazione.
- L'impianto elettrico deve essere dotato di un sezionatore di rete prontamente riconoscibile e utilizzabile in caso di necessità.
- Il terminale di terra disponibile nel prodotto deve essere collegato permanentemente alla terra.
- Collegare il dispositivo ad una sorgente d'alimentazione corrispondente a quella indicata nell'etichetta di marcatura. Prima di procedere con l'installazione verificare che la linea elettrica sia opportunamente sezionata. La tensione di alimentazione non deve eccedere i limiti ($\pm 10\%$).
- L'alimentazione deve essere fornita da una sorgente isolata di tipo SELV, 24Vac, 8A derivata da un trasformatore a doppio isolamento UL Listed, opportunamente protetto in uscita.
- Il dispositivo va montato in modo da non essere accessibile al personale diverso dal tecnico/ installatore in quanto, essendo dotato di parti mobili, rimane residuo il pericolo di ferirsi a seguito dei movimenti delle parti mobili.
- Applicare l'etichetta Parti Mobili Pericolose vicino all'unità (Fig. 4, pagina 12).
- Non utilizzare l'apparecchio in presenza di sostanze infiammabili.
- Per la connessione della linea di alimentazione utilizzare l'apposita scatola di connessione (UPTJ BUL). Per ulteriori informazioni fare riferimento al manuale d'uso ed installazione del prodotto.

- Non permettere l'uso dell'apparecchio a bambini o personale non autorizzato.
- La manutenzione del dispositivo deve essere eseguita solo da personale qualificato. Durante le operazioni di manutenzione l'operatore è esposto al rischio di folgorazione o ad altri pericoli.
- Utilizzare solo gli accessori indicati dal costruttore. Qualsiasi cambiamento non espressamente approvato dal costruttore fa decadere la garanzia.
- Collegare a terra il cavo coassiale.
- Prima di collegare tutti i cavi di segnale verificare che l'unità sia opportunamente collegata al circuito di terra.
- Se il dispositivo deve essere rimosso dall'impianto, scollegare sempre per ultimo il cavo di terra.
- Adottare le dovute precauzioni per evitare di danneggiare l'apparecchiatura con scariche elettrostatiche.
- L'unità è stata realizzata per essere collegata con cavo tripolare. Seguire le indicazioni per un corretto collegamento del circuito di terra descritte nel presente manuale.
- Maneggiare con cura l'unità, forti sollecitazioni meccaniche potrebbero danneggiarla.
- Porre particolare attenzione alle distanze di isolamento tra la linea di alimentazione e tutti gli altri cavi compresi i dispositivi di protezione contro i fulmini.
- È possibile trasportare il dispositivo solo prestando la massima attenzione. Fermate brusche, dislivelli e impatti violenti possono causare danneggiamenti all'oggetto o ferite per l'utente.

4 Identificazione

4.1 Descrizione e designazione del prodotto

ULISSE MAXI è una robusta ed efficiente unità PTZ progettata per garantire una sorveglianza dinamica e non-stop di ampie aree esterne e resistere a condizioni atmosferiche difficili.

Questo modello permette di contenere e gestire gli obiettivi motorizzati più voluminosi del mercato, fino a quasi 8 chili di peso totale.

Un'unica unità può in questo modo assicurare un'ampia copertura a 360° della zona da sorvegliare.

Per garantire immagini dettagliate anche durante le ore notturne, sono disponibili versioni con illuminatori a LED, con luce ad infrarosso o luce bianca.

La robusta struttura meccanica e i potenti motori di questo PTZ sono studiati per garantire la massima resistenza ad un elevato stress di funzionamento, alle vibrazioni e a temperature da -10°C a +60°C.

L'unità è provvista di sensori ottici che garantiscono il preciso controllo della posizione in qualsiasi condizione di utilizzo.

L'unità è dotata di tergicristallo per pulizia del vetro frontale da pioggia e polvere; è disponibile una vasta scelta di taniche con pompa lavavetro con diverse capacità e prevalenze.

Sono disponibili modelli per visione con telecamera termica.

4.2 Marcatura del prodotto

i Sui brandeggi è applicata una etichetta conforme alla marcatura CE.

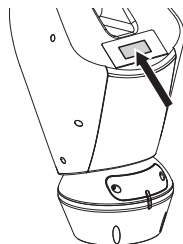

Fig. 1

L'etichetta riporta:

- Codice di identificazione del modello (Codice a barre Extended 3/9).
- Tensione di alimentazione (Volt).
- Frequenza (Hertz).
- Corrente assorbita (Ampere).
- Grado di protezione (IP).
- Numero di serie.

4.2.1 Controllo della marcatura

Prima di procedere con l'installazione controllare che il materiale fornito corrisponda alle specifiche richieste, esaminando le etichette di marcatura.

Non effettuare per nessun motivo alterazioni o collegamenti non previsti in questo manuale. L'uso di apparecchi non idonei può portare a gravi pericoli per la sicurezza del personale e dell'impianto.

5 Versioni

5.1 Illuminatori a LED

⚠ La versione con illuminatori a LED è alimentabile solamente in 24Vac.

Il brandeggio può essere dotato di un supporto per montaggio di 2 illuminatori a LED VIDEOTEC per la visione notturna (illuminatori non inclusi).

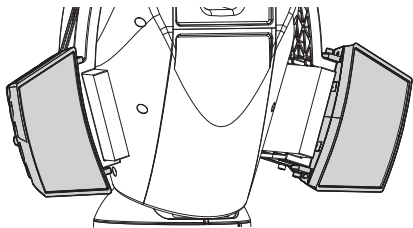

Fig. 2

i Per ulteriori informazioni fare riferimento al relativo capitolo (8.8 Montaggio degli illuminatori a LED, pagina 28).

5.2 Finestra in germanio

La versione con finestra in germanio è stata studiata per applicazioni con telecamere termiche.

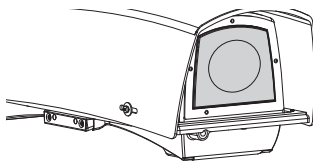

Fig. 3

6 Preparazione del prodotto per l'utilizzo

! **Qualsiasi cambiamento non espressamente approvato dal costruttore fa decadere la garanzia.**

! **L'unità non deve essere smontata o manomessa. Le uniche eccezioni sono quelle che riguardano le operazioni di montaggio e manutenzione previste nel presente manuale.**

6.1 Precauzioni di sicurezza prima dell'utilizzo

! **L'apparecchiatura comprende parti mobili. Assicurarsi che l'unità venga posizionata in un'area non accessibile durante le normali condizioni di funzionamento. Applicare l'apposita etichetta fornita assieme all'apparecchio nelle sue vicinanze ed in modo ben visibile.**



Fig. 4

6.2 Disimballaggio

Alla consegna del prodotto verificare che l'imballo sia integro e non abbia segni evidenti di cadute o abrasioni.

In caso di evidenti segni di danno all'imballo contattare immediatamente il fornitore.

Conservare l'imballo nel caso sia necessario inviare il prodotto in riparazione.

i **Disimballare il tettuccio del dispositivo avendo cura di non danneggiare la custodia.**

6.3 Contenuto

Controllare che il contenuto sia corrispondente alla lista del materiale sotto elencata:

- Unità di posizionamento
- Base di alimentazione
- Imballo degli accessori:
 - Adattatore seriale
 - Cavo prolunga seriale
 - Chiavi a brugola
 - Distanziali
 - Distanziali (non presenti nella versione con telecamera integrata)
 - Etichetta
 - Fascette
 - Guaina siliconica
 - Guarnizioni di riduzione per pressacavi
 - Manuale di istruzioni
 - Piastra di fissaggio per sacchetto disidratante
 - Sacchetto disidratante
 - Viteria
- Imballo dei contrappesi:
- Staffa per fissaggio illuminatori a LED (presente nelle versioni con illuminatori a LED)
- Contrappesi
- Supporti per contrappesi
- Tettuccio

6.4 Smaltimento in sicurezza dei materiali di imballaggio

I materiali d'imballo sono costituiti interamente da materiale riciclabile. Sarà cura del tecnico installatore smaltirli secondo le modalità di raccolta differenziata o comunque secondo le norme vigenti nel Paese di utilizzo.

In caso di restituzione del prodotto malfunzionante è consigliato l'utilizzo dell'imballaggio originale per il trasporto.

6.5 Lavoro preparatorio prima dell'installazione

6.5.1 Fissaggio del supporto

 Per installazioni soggette a vibrazioni utilizzare solamente il supporto da parapetto.

Sono disponibili diversi tipi di supporto (11 Accessori, pagina 52). Scegliere il supporto adeguato all'installazione e seguire tutte le istruzioni nel capitolo indicato.

 **Porre particolare attenzione ai sistemi di fissaggio dell'apparecchiatura. Il sistema di fissaggio deve essere in grado di reggere almeno 4 volte il peso dell'intera apparecchiatura, comprensiva di brandeggio, lenti e telecamera.**

 **Il dispositivo deve essere montato in posizione verticale. Ogni posizionamento alternativo potrebbe compromettere le prestazioni dell'apparecchiatura.**

 **Non montare il dispositivo capovolto.**

6.5.2 Passaggio cavi

 **I cavi di collegamento non devono essere accessibili dall'esterno. I cavi devono essere opportunamente fissati al sostegno per evitare che l'eccessivo peso ne comporti lo sfilamento accidentale.**

 **I cavi utilizzati devono essere conformi al tipo di installazione.**

Introdurre i cavi all'interno del supporto in modo che fuoriescano per circa 50cm.

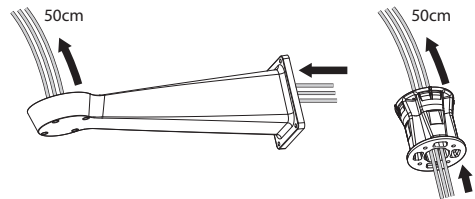

Fig. 5

7 Assemblaggio

7.1 Fissaggio del tettuccio

Fissare il tettuccio alla custodia tramite le 4 viti e le 4 coppie di rondelle fornite in dotazione.

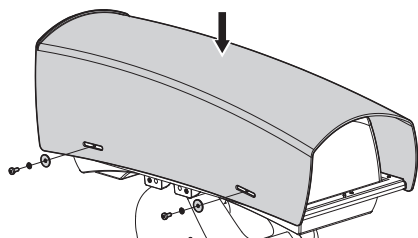

Fig. 6

7.2 Apertura della custodia

Svitare le viti antiperdita poste sui fianchi e sollevare la parte superiore della custodia.

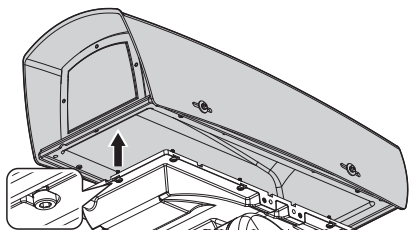

Fig. 7



Al termine delle operazioni di installazione e cablaggio richiudere il prodotto.

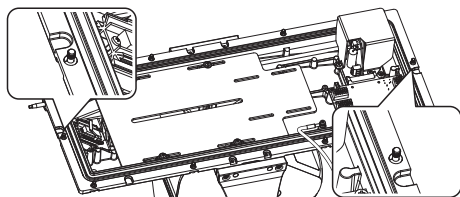

Fig. 8



Serrare per prime le due viti centrali come illustrato in figura.

7.3 Montaggio telecamera e ottiche motorizzate

Il montaggio della telecamera e dei relativi obiettivi è a cura del cliente.

7.3.1 Caratteristiche delle telecamere



Il corretto funzionamento dell'apparecchiatura, nel range di temperatura indicato, è garantito solo se si utilizzano telecamera ed ottica con limiti di temperatura pari ad almeno -10°C e +60°C.

- La tensione di alimentazione dalla telecamera deve essere 12Vdc.
- La corrente massima assorbita dalla telecamera deve essere inferiore al valore indicato di seguito: 800mA.
- Il segnale video in uscita dalla telecamera deve essere di tipo composito con ampiezza 1Vpp (sync negativo).

7.3.2 Fissaggio dell'ottica e della telecamera alla slitta interna

! È necessario isolare il corpo della telecamera dalla slitta di fissaggio per evitare disturbi sul segnale video.

! Il peso complessivo massimo consentito per la telecamera e l'ottica non deve superare i 7.6kg.

Connettere la telecamera (02) all'ottica (01).

Fissare la staffetta a L in alluminio (03) alla telecamera tramite la rondella in nylon (04) e la vite da 1/4" (05).

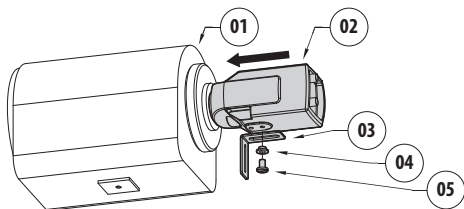

Fig. 9

Posizionare l'ottica sulla slitta (02) interponendo il distanziale in plastica (01). Fissare il tutto con la rondella in nylon (03) e la vite da 1/4" (04).

Se necessario utilizzare i distanziali supplementari per posizionare in modo corretto telecamera e ottica.

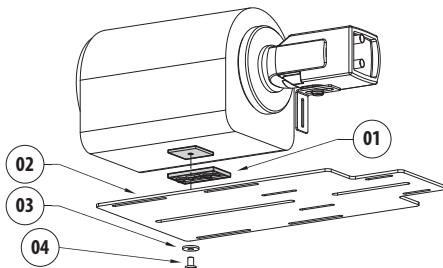

Fig. 10

Fissare la piastra in alluminio (01) sulla slitta tramite le viti e le relative rondelle (02).

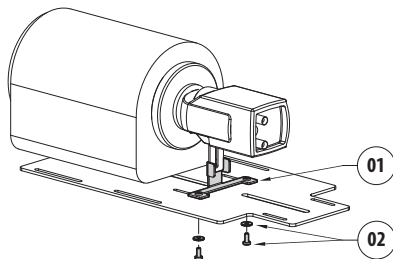

Fig. 11

Fissare la staffetta ad L con la vite.

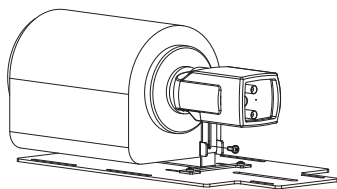

Fig. 12

7.3.3 Posizionamento del distanziale H-20 sulla slitta interna

È possibile fissare un distanziale H-20 (02) all'ottica. Connettere la telecamera e fissare la staffetta a L (Fig. 9, pagina 15). Interporre un distanziale di plastica (01) dello spessore desiderato e fissarlo con la rondella e la vite (03).

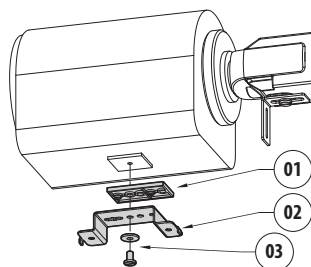

Fig. 13

Posizionare l'ottica con il distanziale sulla slitta interna (01) e fissare tramite le rondelle e le viti (02) fornite in dotazione.

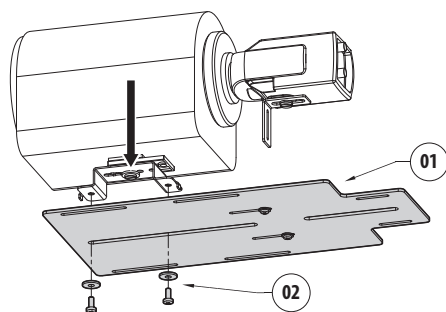

Fig. 14

Concludere il fissaggio come illustrato nelle figure (Fig. 11, pagina 15 e Fig. 12, pagina 15).

7.3.4 Posizionamento della slitta interna

Far scorrere la slitta interna con ottica e telecamera già fissate nella posizione desiderata e fissarla tramite le viti e le rondelle in dotazione.

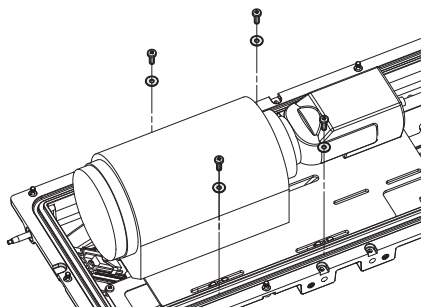

Fig. 15

7.4 Descrizione della scheda della custodia

DESCRIZIONE DELLA SCHEDA	
Connettore/Morsetto	Funzione
CN1	Connettore BNC, segnale video dalla telecamera
CN2	Connettore controllo motori ottiche motorizzate
CN3	Connettore potenziometri ottiche motorizzate
CN6	Connettore seriale per il controllo della telecamera
CN7	Alimentazione telecamera, contatto pulito per l'attivazione della modalità Day/Night della telecamera, linee aggiuntive
DIP1	Selezione della tensione di alimentazione delle ottiche

Tab. 1

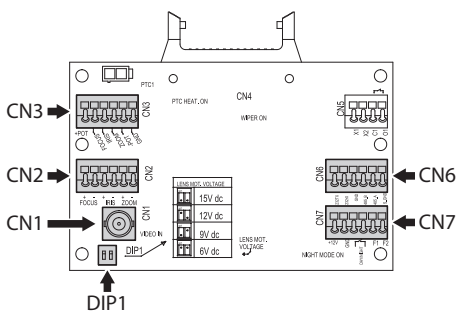

Fig. 16

7.4.1 Collegamento della telecamera e dell'ottica motorizzata



Tutti i collegamenti illustrati di seguito devono essere eseguiti solo da installatori esperti e devono essere rispettate tutte le specifiche di cablaggio e di alimentazione dei dispositivi.

La scheda elettronica è predisposta per poter controllare telecamere con ottiche motorizzate, dotate o meno di potenziometri per il controllo della posizione raggiunta.



Prima di procedere ai collegamenti, verificare che le tensioni fornite dalla scheda rientrino nei limiti previsti per l'apparecchiatura.

CONNETTORE DELLA TELECAMERA CON OTTICHE MOTORIZZATE		
Tensione	Corrente	Descrizione
+12V	800mA max	Alimentazione telecamera
+5V	15mA max	Alimentazione potenziometri ottiche
Da 6Vdc fino a 15Vdc (regolabile)	200mA max (Focus+Zoom+Iris)	Alimentazione motori ottiche

Tab. 2

Ottiche con motori ad inversione di polarità: Eseguire le connessioni come illustrato in figura.

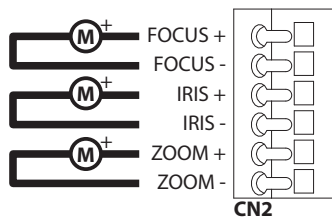

Fig. 17 CN2.

Ottiche con motori a filo comune: Eseguire le connessioni come illustrato in figura.

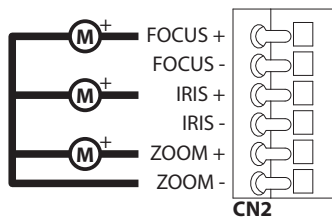

Fig. 18 CN2.

Potenzimetri: Eseguire le connessioni come illustrato in figura.

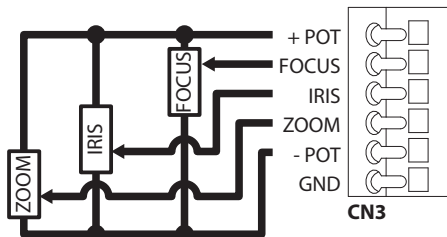

Fig. 19 CN3.

Telecamera: Eseguire le connessioni come illustrato in figura.

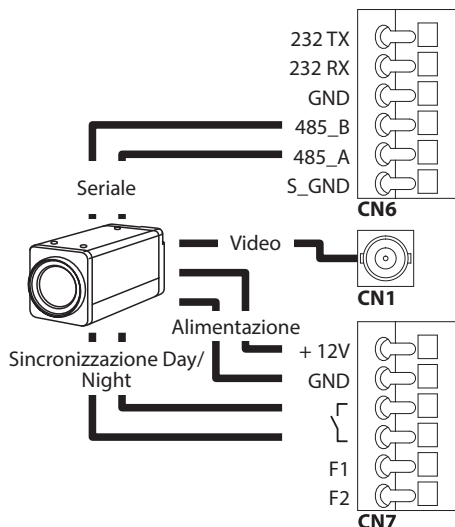

Fig. 20

Per abilitare il controllo della telecamera fare riferimento al relativo capitolo (10.1.6 Menù Seriale Custodia, pagina 45).

7.4.2 Regolazione della tensione di alimentazione dei motori delle ottiche

Prima di alimentare il brandeggio, selezionare la tensione di alimentazione delle ottiche agendo sul DIP1 (7.4 Descrizione della scheda della custodia, pagina 17).

REGOLAZIONE DELLA TENSIONE DI ALIMENTAZIONE DEI MOTORI DELLE OTTICHE

SW1	SW2	Tensione
OFF	OFF	15Vdc
ON	OFF	12Vdc
OFF	ON	9Vdc
ON	ON	6Vdc

Tab. 3

8 Installazione

! Non effettuare per nessun motivo alterazioni o collegamenti non previsti in questo manuale. Il mancato rispetto delle indicazioni fornite nel manuale in merito ai collegamenti può portare a gravi pericoli per la sicurezza del personale e dell'impianto.

! Non modificare i cablaggi già presenti nel prodotto. Il mancato rispetto di questa indicazione può portare a gravi pericoli per la sicurezza del personale e dell'impianto, oltre a far decadere la garanzia.

i In caso di utilizzo del kit lavavetro, il supporto per l'ugello deve essere installato prima del posizionamento del brandeggio dei cablaggi. Per ulteriori chiarimenti, fare riferimento al manuale del kit specifico.

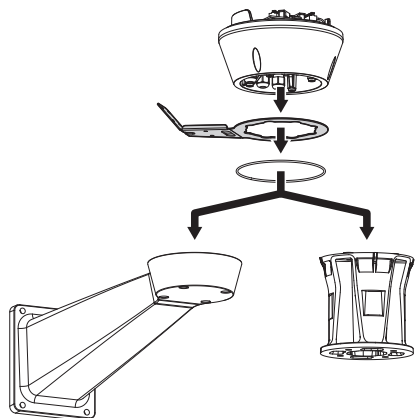

Fig. 21

i All'interno della calotta inferiore è presente un sacchetto disidratante utile per evitare la formazione di umidità nella base ed in corrispondenza alle schede connettori. Rimuovere il sacchetto prima dell'installazione.

8.1 Collegamento dei cavi alla base

Introdurre i cavi all'interno dei pressacavi tenendo la base a circa 20cm dal supporto. Serrare i pressacavi. I pressacavi sono adatti per cavi con diametro compreso tra 5mm e 10mm.

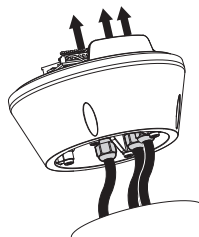

Fig. 22

! Prestare attenzione durante il fissaggio. Coppia di serraggio: 5Nm.

i Per cavi di diametro da 3mm a 7mm utilizzare gli appositi gommini in dotazione.

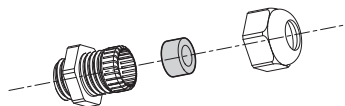

Fig. 23

8.2 Fissaggio della base al supporto

⚠ Utilizzare le viti e le rondelle fornite con la base.

Dopo aver posizionato la guarnizione (01), fissare la base (02) sul supporto (03) utilizzando le viti (04), le rondelle dentellate (05) e gli anelli per vite (06).

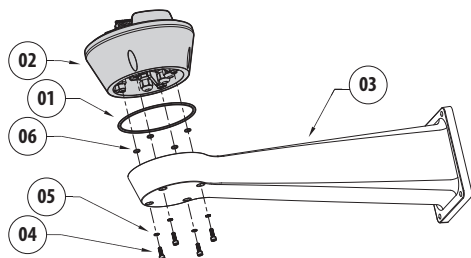

Fig. 24

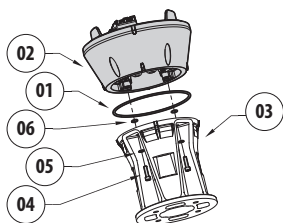

Fig. 25

Allineare le 3 tacche sulla base con quelle presenti sui supporti come illustrato nella figura seguente.

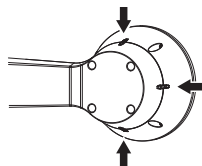

Fig. 26

⚠ Applicare del frenafili nei fori delle viti (Loctite 243®).

⚠ Prestare attenzione durante il fissaggio. Coppia di serraggio: 6Nm.

Tab. 4

8.3 Descrizione della scheda connettori

DESCRIZIONE DELLA SCHEDA CONNETTORI	
Connettore/Componente	Funzione
J6	Alimentazione della scheda
J7	Cavi di segnale
J4	RS-232
F1	Fusibile
F2	Fusibile

Tab. 5 Versione standard.

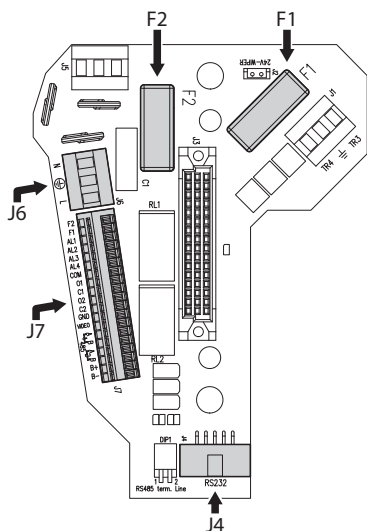

Fig. 27 Versione standard.

DESCRIZIONE DELLA SCHEDA CONNETTORI	
Connettore/Componente	Funzione
J6	Alimentazione della scheda
J7	Cavi di segnale
J4	RS-232
F1	Fusibile
F2	Fusibile

Tab. 6 Versione con illuminatori a LED.

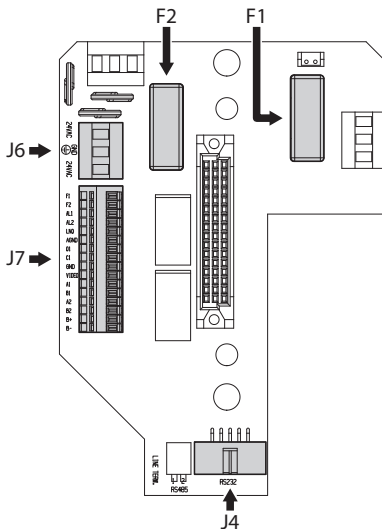

Fig. 28 Versione con illuminatori a LED.

8.4 Collegamento della linea di alimentazione

A seconda della versione, al dispositivo possono essere fornite diverse tensioni di alimentazione. Il valore di tensione di alimentazione è riportato nell'etichetta identificativa del prodotto (4.2 Marcatura del prodotto, pagina 10).

Eseguire le connessioni elettriche in assenza di alimentazione e con dispositivo di sezionamento aperto.

All'atto dell'installazione controllare che le caratteristiche di alimentazione fornite dall'impianto corrispondano a quelle richieste dal dispositivo.

Verificare che la sorgente e il cavo di alimentazione siano adeguatamente dimensionati.

Il cavo di terra deve essere più lungo degli altri due di circa 10mm per prevenirne il distacco accidentale a causa dello stiramento.

Il cavo di alimentazione deve essere coperto con la guaina siliconica (01) presente nella dotazione. La guaina siliconica deve essere fissata con l'apposita fascetta (02).

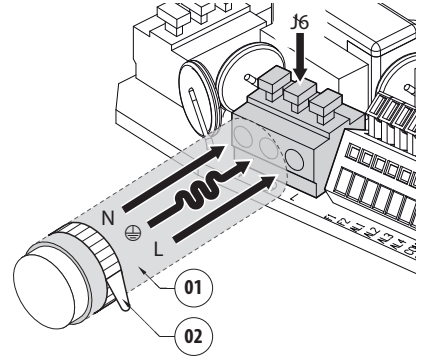

Fig. 29

8.4.1 Collegamento della linea di alimentazione in 24Vac

Tagliare a misura i cavi e realizzare i collegamenti. Collegare la linea di alimentazione al seguente morsetto: J6.

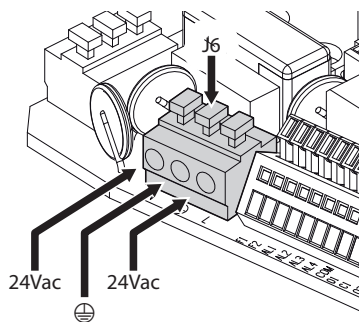

Fig. 30 Versione standard.

8.4.2 Collegamento della linea di alimentazione in 120Vac e 230Vac

Tagliare a misura i cavi e realizzare i collegamenti. Collegare la linea di alimentazione al seguente morsetto: J6.

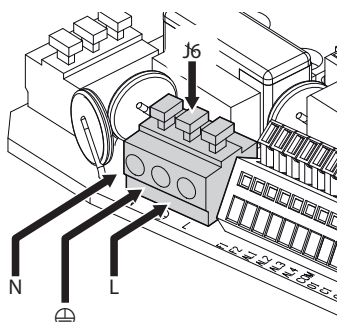

Fig. 32 Versione standard.

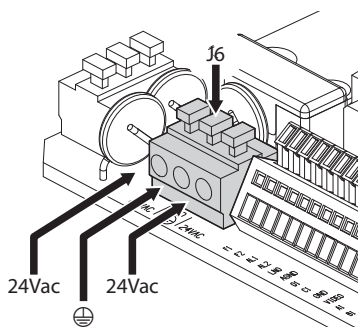

Fig. 31 Versione con illuminatori a LED.

Collegare i cavi di alimentazione come descritto nella tabella sottostante.

COLLEGAMENTO DELLA LINEA DI ALIMENTAZIONE	
Colore	Morsetti
Alimentazione 24Vac	
Definito dall'installatore	24Vac
Definito dall'installatore	24Vac
Giallo/Verde	⊕

Tab. 7

Collegare i cavi di alimentazione come descritto nella tabella sottostante.

COLLEGAMENTO DELLA LINEA DI ALIMENTAZIONE	
Colore	Morsetti
Alimentazione 230Vac	
Blu	N (Neutro)
Marrone	L (Fase)
Giallo/Verde	⊕
Alimentazione 120Vac	
Blu	N (Neutro)
Marrone	L (Fase)
Giallo/Verde	⊕

Tab. 8

8.5 Collegamento dei cavi di segnale

! Tutti i cavi di segnale devono essere raggruppati con una fascetta.

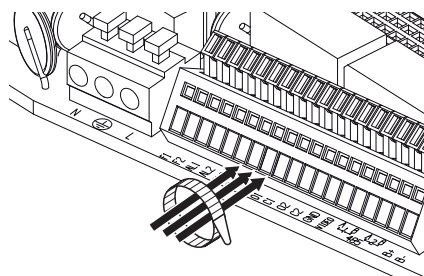

Fig. 33

8.5.1 Collegamento del cavo video

! **ATTENZIONE!** Per ridurre il rischio di incendio usare solamente cavi certificati UL Listed o CSA aventi sezioni maggiori o uguali a 0.14mm^2 (26AWG).

! L'impianto è di tipo CDS (Cable Distribution System). Non collegare a circuiti SELV.

! Collegare lo schermo e il cavo centrale rispettivamente ai morsetti GND e VIDEO. I morsetti accettano cavi di sezione compresa tra 0.5mm^2 (20AWG) e 0.08mm^2 (28AWG).

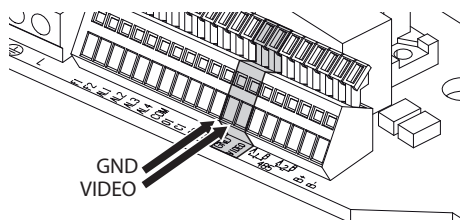

Fig. 34 Versione standard.

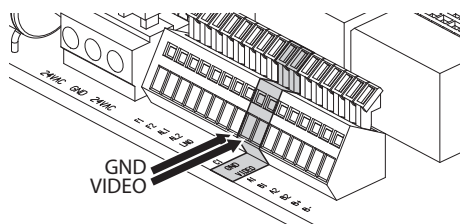

Fig. 35 Versione con illuminatori a LED.

8.5.2 Collegamento delle linee di telemetria

ATTENZIONE! L'installazione è di tipo TNV-1. Non collegare a circuiti SELV.

ATTENZIONE! Per ridurre il rischio di incendio usare solamente cavi certificati UL Listed o CSA aventi sezioni maggiori o uguali a 0.14mm² (26AWG).

Il prodotto prevede due linee seriali di comunicazione RS-485 e una linea seriale RS-232 (solo per aggiornamento del firmware).

Le linee di telemetria possono essere configurate in vari modi secondo la posizione dei dip-switch 10 e 9 del selettore Seriali e Indirizzo (8.14.4.2 Configurazione delle linee di comunicazione seriali, pagina 35).

Linee seriali RS-485

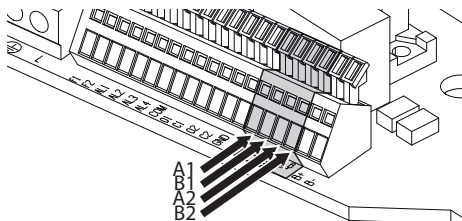

Fig. 36 RS-485. Versione standard.

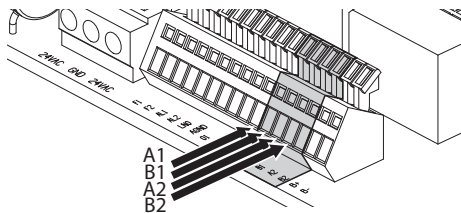

Fig. 37 RS-485. Versione con illuminatori a LED.

COLLEGAMENTO DELLE LINEE DI TELEMETRIA

Morsetti	Descrizione
A1-B1	Linea RS-485 (1)
A2-B2	Linea RS-485 (2)

Tab. 9

Linea seriale RS-232

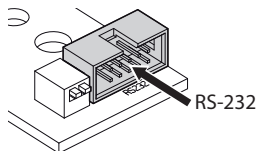

Fig. 38 RS-232.

8.5.3 Collegamento degli ingressi di allarme, dell'interruttore crepuscolare e dei relè

ATTENZIONE! L'installazione è di tipo TNV-1. Non collegare a circuiti SELV.

ATTENZIONE! Per ridurre il rischio di incendio usare solamente cavi certificati UL Listed o CSA aventi sezioni maggiori o uguali a 0.14mm² (26AWG).

Versione standard

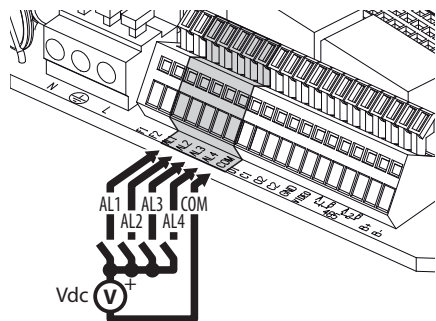

Fig. 39 Ingressi di allarme.

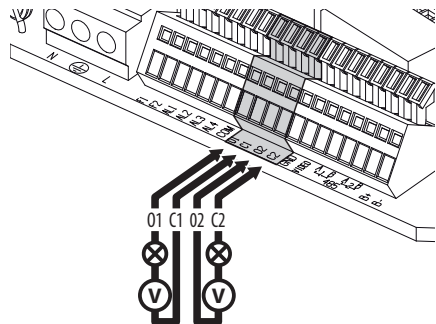

Fig. 40 Relè.

COLLEGAMENTO DEGLI INGRESSI DI ALLARME E DEI RELÈ

Morsetti	Descrizione
AL1, AL2, AL3, AL4 e COM	Ingressi di allarme controllati in tensione riferiti al morsetto comune COM
F1-F2	Riservati per utilizzi futuri
O1-C1 e O2-C2	Contatti puliti di uscita attivabili da allarme o da comando utente

Tab. 10 Versione standard.

Versione con illuminatori a LED

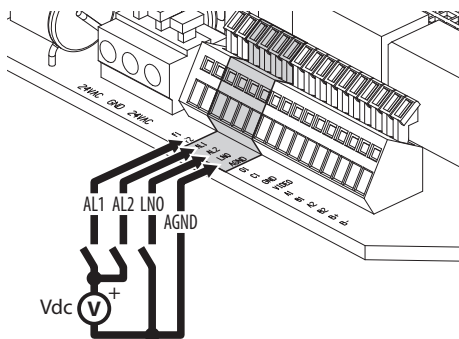

Fig. 41 Ingressi di allarme e interruttore crepuscolare.

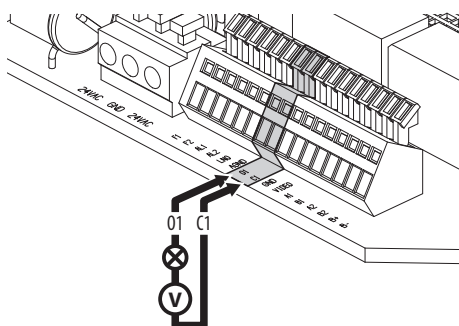

Fig. 42 Relè.

COLLEGAMENTO DEGLI INGRESSI DI ALLARME, DELL'INTERRUTTORE CREPUSCOLARE E DEI RELÈ

Morsetti	Descrizione
AL1, AL2 e AGND	Ingressi di allarme controllati in tensione riferiti al morsetto comune AGND
F1-F2	Riservati per utilizzi futuri
LNO e AGND	Interruttore crepuscolare (contatto pulito)
O1-C1	Contatti puliti di uscita attivabili da allarme o da comando utente

Tab. 11 Versione con illuminatori a LED.

8.6 Fissaggio del corpo superiore

Fissare il corpo superiore (01) alla base (02) tramite le viti di fissaggio (03) dotate di guarnizioni (04). Controllare che sia presente e in buono stato la guarnizione della base (05).

⚠ Prestare attenzione durante il fissaggio. Coppia di serraggio: 4Nm.

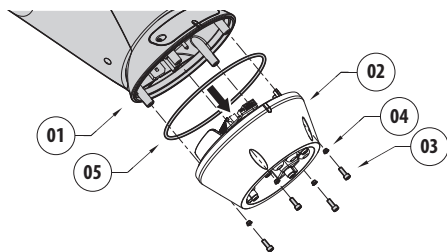

Fig. 43

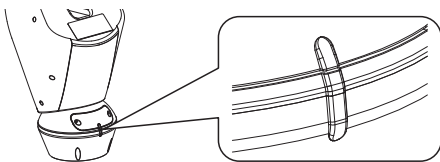

Fig. 44

i Esiste un'unica posizione di ancoraggio tra la base e corpo superiore. Allineare le sporgenze laterali per un corretto posizionamento.

8.7 Montaggio dei contrappesi

Fissare i contrappesi alla custodia usando le viti e le rondelle in dotazione.

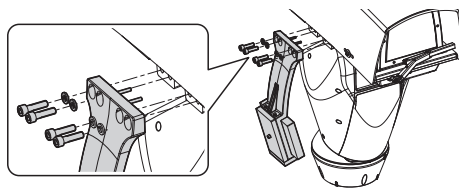

Fig. 45

⚠ Applicare del frenafletti nei fori delle viti (Loctite 243®).

⚠ Prestare attenzione durante il fissaggio. Coppia di serraggio: 16Nm.

8.8 Montaggio degli illuminatori a LED

! Per un corretto funzionamento si devono sempre installare entrambi gli illuminatori.

i Sul brandeggio è possibile installare esclusivamente illuminatori VIDEOTEC.

8.8.1 Rimozione dei contrappesi

Svitare le viti e rimuovere i contrappesi esterni.

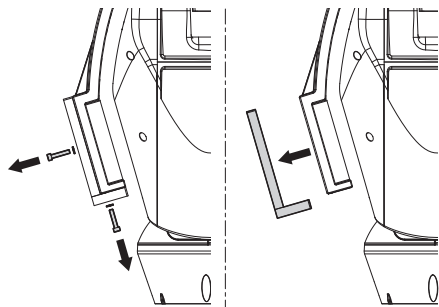

Fig. 46

8.8.2 Montaggio dell'illuminatore sulla staffa

Individuare i fori anteriori presenti sulla staffa del contrappeso.

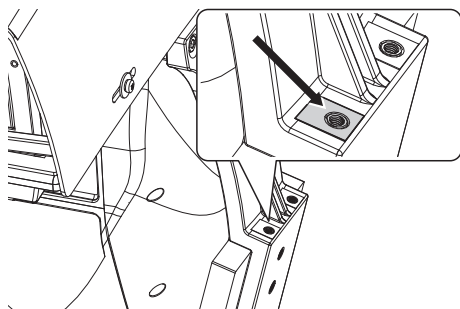

Fig. 47

Posizionare i fissaggi dell'illuminatore (01) su quelli della staffa (02).

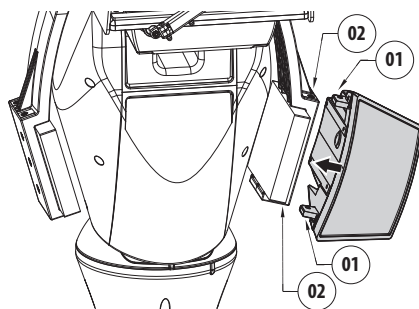

Fig. 48

Avvitare le viti e le rondelle precedentemente rimosse.

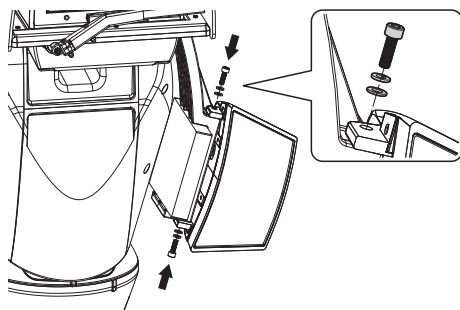

Fig. 49

! Prestare attenzione durante il fissaggio.
Coppia di serraggio: 6Nm.

8.9 Collegamento degli illuminatori a LED

Rimuovere i 2 tappi M12. Avvitare i 2 pressacavi e i rispettivi O-ring forniti in dotazione.

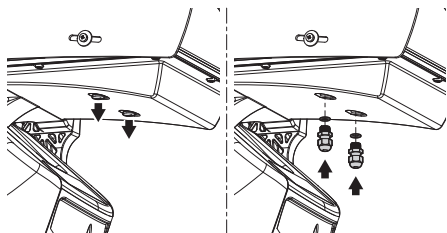

Fig. 50

⚠ Per non compromettere la sicurezza e il funzionamento dell'unità non lasciare eccedenza di cavo all'esterno.

Fig. 51

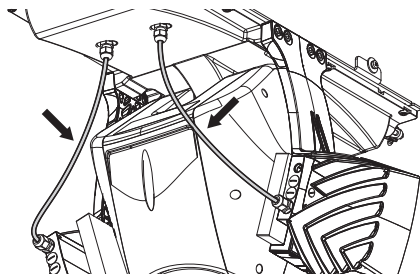

Fig. 52

Collegare i cavi come illustrato in figura.

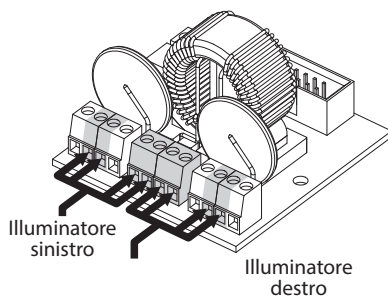

Fig. 53

COLLEGAMENTO DEGLI ILLUMINATORI A LED			
Illuminatore sinistro		Illuminatore destro	
Riferimento sulla scheda	Colore del cavo	Riferimento sulla scheda	Colore del cavo
WH	Bianco	WH	Bianco
BK	Nero	BK	Nero
A1	Verde	A2	Verde
B1	Rosso	B2	Rosso

Tab. 12

8.10 Collegamento per la sincronizzazione della telecamera con gli illuminatori a LED

Telecamere ZFI dotate di filtro infrarosso:

Collegare l'ingresso di commutazione tra le modalità Day/Night della telecamera al connettore Night Mode (contatto pulito) come illustrato in figura.

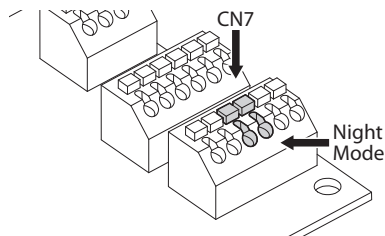

Fig. 54

8.11 Sacchetto disidratante

Inserire i sacchetti disidratanti (01) nella posizioni indicate in figura, dopo averli tolti dalla confezione trasparente e piegati in due. Fissare i sacchetti tramite le piastrine (02) e le viti in dotazione (03).

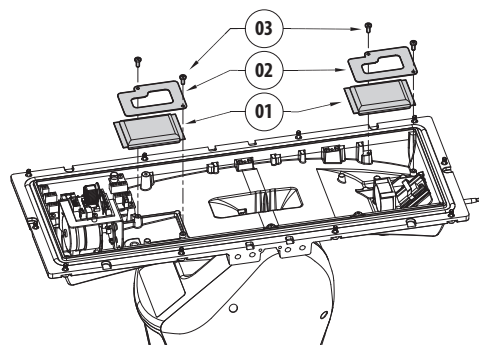

Fig. 55

8.12 Regolazione e modalità di attivazione degli illuminatori a LED

Una volta effettuata la regolazione, l'illuminatore di sinistra (MASTER) sincronizza e controlla l'illuminatore di destra (SLAVE).

L'interruttore crepuscolare rileva la luce ambientale e controlla l'accensione e lo spegnimento degli illuminatori quando la luminosità raggiunge il livello impostato dall'utilizzatore.

Un segnale di commutazione Day/Night è inviato alla telecamera all'accensione degli illuminatori a LED (8.10 Collegamento per la sincronizzazione della telecamera con gli illuminatori a LED, pagina 30).

8.12.1 Descrizione dell'illuminatore a LED



Per non compromettere la sicurezza e il funzionamento dell'illuminatore non rimuovere la vite trasparente del sensore crepuscolare.

- **Sensore crepuscolare:** Rileva il livello di luminosità.
- **Cavo:** Alimentazione e controllo.
- **Regolatore soglia accensione:** Il potenziometro permette di regolare il livello di sensibilità per l'accensione dell'illuminatore.
- **Regolatore potenza infrarossi:** Il potenziometro permette di regolare la potenza dell'illuminatore.

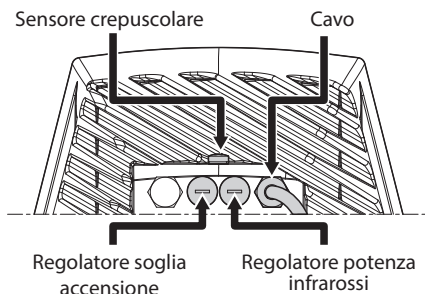

Fig. 56

8.12.2 Attivazione degli illuminatori a LED tramite un interruttore crepuscolare esterno

Effettuare le seguenti operazioni:

- Collegare l'interruttore crepuscolare ai morsetti: LNO/AGND (8.5.3 Collegamento degli ingressi di allarme, dell'interruttore crepuscolare e dei relè, pagina 26).
- Regolare l'illuminatore sinistro (MASTER):
 - **Soglia di accensione:** Impostare il valore al minimo (8.12.4 Regolazione della soglia di accensione degli illuminatori a LED, pagina 32).
 - **Potenza degli infrarossi:** Impostare il valore secondo necessità (8.12.5 Regolazione della potenza degli illuminatori a LED, pagina 32).
- Regolare l'illuminatore destro (SLAVE):
 - **Soglia di accensione:** Impostare il valore al massimo (8.12.4 Regolazione della soglia di accensione degli illuminatori a LED, pagina 32).
 - **Potenza degli infrarossi:** Impostare il valore al minimo (8.12.5 Regolazione della potenza degli illuminatori a LED, pagina 32).
- Associare il valore Esterna alla voce Sonda IR del menù Parametri ZFI (10.1.5 Menù Parametri ZFI, pagina 42).

```

PARAMETRI ZFI
-----
1>ZOOM                :    30x

3 SONDA IR            :ESTERNA
4 TITOLAZIONE AREE   >
5 MASCHERATURA AREE  >
    
```

Fig. 57

8.12.3 Attivazione degli illuminatori a LED tramite il sensore crepuscolare integrato

Per sincronizzare l'unità con gli illuminatori a LED è necessario:

- Regolare l'illuminatore sinistro (MASTER):
 - **Soglia di accensione:** Impostare il valore secondo necessità (8.12.4 Regolazione della soglia di accensione degli illuminatori a LED, pagina 32).
 - **Potenza degli infrarossi:** Impostare il valore secondo necessità (8.12.5 Regolazione della potenza degli illuminatori a LED, pagina 32).
- Regolare l'illuminatore destro (SLAVE):
 - **Soglia di accensione:** Impostare il valore al massimo (8.12.4 Regolazione della soglia di accensione degli illuminatori a LED, pagina 32).
 - **Potenza degli infrarossi:** Impostare il valore al minimo (8.12.5 Regolazione della potenza degli illuminatori a LED, pagina 32).
- Associare il valore Interna alla voce Sonda IR del menù Parametri ZFI (10.1.5 Menù Parametri ZFI, pagina 42).

```

PARAMETRI ZFI
-----
1>ZOOM                :    30x

3 SONDA IR            :INTERNA
4 TITOLAZIONE AREE   >
5 MASCHERATURA AREE  >
    
```

Fig. 58

8.12.4 Regolazione della soglia di accensione degli illuminatori a LED

! L'illuminatore destro deve sempre essere impostato a luminosità massima.

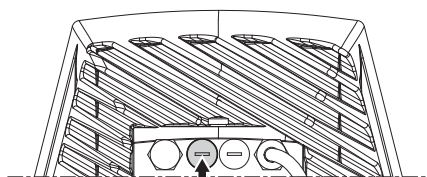

Regolatore soglia accensione

Fig. 59

L'illuminatore ha un sensore crepuscolare integrato che consente l'accensione e lo spegnimento automatico a condizioni luminose prestabilite.

La regolazione del sensore crepuscolare è effettuata in fabbrica ad un livello luminoso prefissato ed idoneo alla maggior parte delle installazioni (circa 50lx). Nel caso si voglia regolare in maniera diversa la soglia di intervento, svitare il tappo posizionato sul retro dell'illuminatore e provvedere alla regolazione tramite un cacciavite.

Ruotando il trimmer in senso orario la commutazione in modalità notturna è anticipata (ad un valore di luminosità maggiore). Ruotando il trimmer in senso antiorario la commutazione in modalità notturna è ritardata (ad un valore di luminosità inferiore).

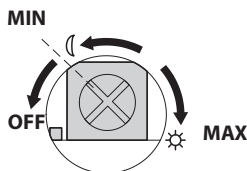

Fig. 60

Attendere le condizioni di luminosità adeguate per l'accensione dell'illuminatore. Ruotare lentamente il trimmer fino all'accensione del LED presente a lato del trimmer. Una volta oltrepassata la soglia di intervento (LED acceso), ruotare leggermente in senso opposto.

! Al termine delle regolazioni accertarsi che il tappo di chiusura sia adeguatamente serrato per garantire la tenuta ermetica del prodotto.

8.12.5 Regolazione della potenza degli illuminatori a LED

! L'illuminatore destro deve sempre essere impostato a potenza minima.

L'illuminatore è regolato in fabbrica per erogare la massima potenza. Qualora non servisse illuminare dettagli lontani o se l'immagine risultasse sovraesposta per l'eccessiva luminosità, diminuire la potenza, ottenendo inoltre un risparmio energetico.

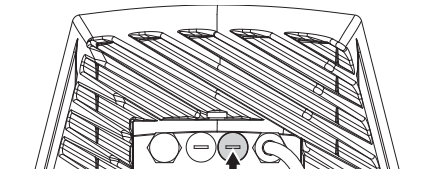

Regolatore potenza infrarossi

Fig. 61

Svitare il tappo di chiusura ermetica. Ruotare il trimmer in senso orario per aumentare la potenza degli infrarossi e in senso antiorario per diminuirli.



Fig. 62

! Al termine delle regolazioni accertarsi che il tappo di chiusura sia adeguatamente serrato per garantire la tenuta ermetica del prodotto.

8.13 Fissaggio della spazzola del tergicristallo

Inserire la spazzola sull'albero del tergicristallo.
Mettere la spazzola nella posizione di riposo.

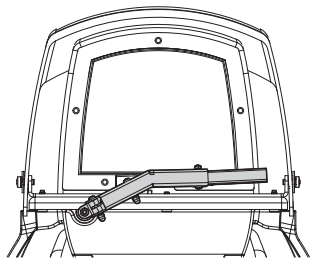

Fig. 63

Fissare il tutto tramite la rondella dentellata e il dado.

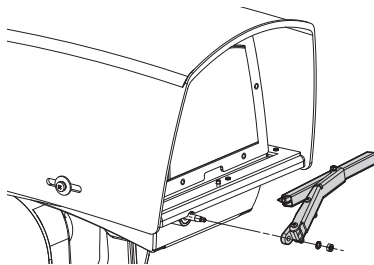

Fig. 64



La regolazione corretta deve permettere alla spazzola di ritornare nella posizione di riposo andando in battuta sulla piastra del corpo.

8.14 Configurazione hardware

8.14.1 Apertura dello sportellino di configurazione

Prima di alimentare il dispositivo, è necessario configurarlo correttamente tramite i dip-switch presenti all'interno dello sportellino di configurazione. Aprire lo sportellino svitando le viti come illustrato in figura.

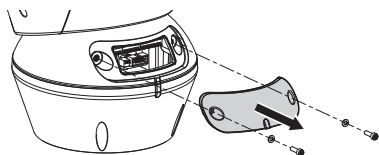

Fig. 65

I DIP-switch si presentano come illustrato in figura.

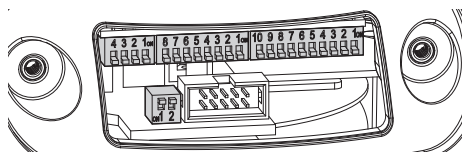

Fig. 66

i Al termine delle operazioni di installazione e cablaggio richiudere il prodotto.

8.14.2 Configurazione del DIP1

i La levetta dello switch verso l'alto rappresenta il valore 1 (ON). La levetta verso il basso rappresenta il valore 0 (OFF).

Lo switch 1 è utilizzato per l'aggiornamento del firmware.

Gli switch 4, 3 e 2 sono utilizzati per selezionare la velocità di comunicazione del dispositivo.

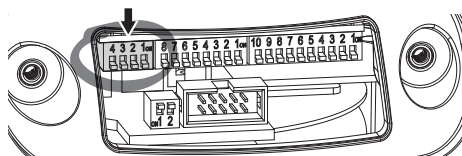

Fig. 67

CONFIGURAZIONE DEL DIP1					
Descrizione	SW 4	SW 3	SW 2	SW 1	Baud rate
Regolazione del baud rate	OFF	OFF	OFF	-	300 baud
	ON	OFF	OFF	-	600 baud
	OFF	ON	OFF	-	1200 baud
	ON	ON	OFF	-	2400 baud
	OFF	OFF	ON	-	4800 baud
	ON	OFF	ON	-	9600 baud
	OFF	ON	ON	-	19200 baud
	ON	ON	ON	-	38400 baud
Aggiornamento firmware	-	-	-	ON	Programmazione abilitata
	-	-	-	OFF	Programmazione disabilitata

Fig. 68

8.14.3 Configurazione del DIP2

i La levetta dello switch verso l'alto rappresenta il valore 1 (ON). La levetta verso il basso rappresenta il valore 0 (OFF).

Il brandeggio è controllabile mediante vari protocolli.

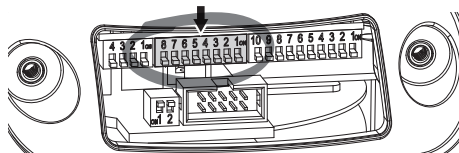

Fig. 69

CONFIGURAZIONE DEL DIP2								
Protocollo	SW 8	SW 7	SW 6	SW 5	SW 4	SW 3	SW 2	SW 1
PTZ Manager ¹	OFF	OFF	OFF	OFF	OFF	OFF	OFF	OFF
MACRO (VIDEOTEC)	OFF	OFF	OFF	OFF	OFF	ON	ON	ON
PANASONIC	OFF	OFF	OFF	ON	OFF	ON	OFF	OFF
PELCO D	OFF	OFF	OFF	OFF	ON	OFF	OFF	ON
AMERICAN DYNAMICS	OFF	OFF	OFF	OFF	ON	ON	ON	OFF
VISTA	OFF	OFF	OFF	ON	OFF	OFF	ON	ON

Tab. 13 ¹ Configurazione di default: MACRO (VIDEOTEC), 115200 baud, Indirizzo 1. Questa opzione non richiede il settaggio dei DIP-switch (DIP1, DIP3).

Tab. 14

8.14.4 Configurazione del DIP3

i La levetta dello switch verso l'alto rappresenta il valore 1 (ON). La levetta verso il basso rappresenta il valore 0 (OFF).

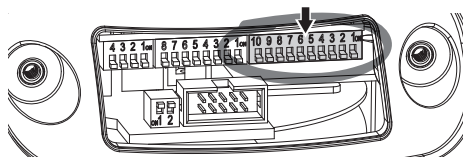

Fig. 70

8.14.4.1 Configurazione dell'indirizzo

Gli switch da 1 a 8 sono utilizzati per configurare l'indirizzo dell'unità (da 1 a 255).

La selezione dell'indirizzo avviene secondo la codifica binaria (A Appendice - Tabella degli indirizzi, pagina 66).

8.14.4.2 Configurazione delle linee di comunicazione seriali

Il prodotto prevede due linee seriali di comunicazione RS-485.

Gli switch 10 e 9 sono utilizzati per configurare le linee seriali.

CONFIGURAZIONE DEL DIP3		
Descrizione	SW 10	SW 9
Comunicazione monodirezionale sulla linea RS-485-1.	OFF	OFF
Comunicazione in full-duplex secondo lo standard RS-422.	OFF	ON
Collegamento di più dispositivi in cascata. Il segnale viene rigenerato da ogni unità.	ON	OFF
Comunicazione bidirezionale, half-duplex, sulla linea RS-485-1.	ON	ON

Tab. 15

i Per ulteriori informazioni fare riferimento al relativo capitolo (8.14.6 Esempi di installazione, pagina 36).

8.14.5 Configurazione del DIP4

i Il settaggio di questo DIP avviene in maniera inversa dai precedenti. La levetta dello switch verso l'alto rappresenta il valore 0 (OFF). La levetta verso il basso rappresenta il valore 1 (ON).

Sulla scheda sono presenti due switch usati per configurare la terminazione (120 Ohm) delle linee seriali.

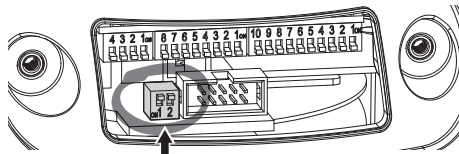

Fig. 71

Ogni unità che si trovi a fine linea deve essere terminata utilizzando l'apposito switch in modo da evitare riflessioni e deformazioni del segnale.

Gli switch 1 e 2 terminano rispettivamente le linee seriali RS-485-1 e RS-485-2.

CONFIGURAZIONE DEL DIP4			
Linea seriale	SW 2	SW 1	Descrizione
Linea RS-485-1	-	ON	Terminata
	-	OFF	Non terminata
Linea RS-485-2	ON	-	Terminata
	OFF	-	Non terminata

Tab. 16

8.14.6 Esempi di installazione

8.14.6.1 Linea RS-485 RX

La linea RS-485-1 funziona secondo le impostazioni settate con i dip-switch Indirizzio, Baud rate e Protocollo.

La linea seriale RS-485-2 non è utilizzata.

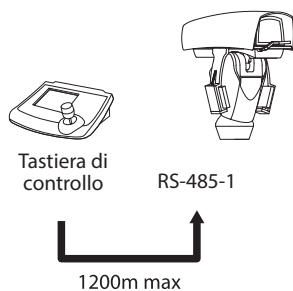

Fig. 72

ATTENZIONE! L'installazione è di tipo TNV-1. Non collegare a circuiti SELV.

8.14.6.2 Linea RS-422 (RS-485-1 RX e RS-485-2 TX)

Questa impostazione permette la comunicazione in full duplex secondo lo standard RS-422. Vengono pertanto impegnate le due linee RS-485-1 e RS-485-2.

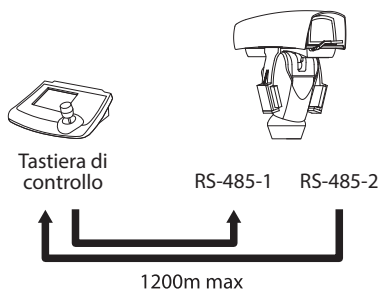

Fig. 73

i Questa funzione è disponibile soltanto con protocolli bidirezionali (esempio: PELCO, AMERICAN DYNAMICS, VIDEOTEC MACRO, ecc.).

8.14.6.3 Linea RS-485-1 ricezione, linea RS-485-2 ripetizione

Questa impostazione permette di collegare più dispositivi in cascata. Il segnale è rigenerato da ogni unità permettendo di aumentare notevolmente la distanza totale.

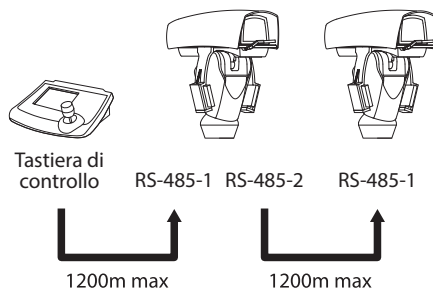

Fig. 74

i Questa configurazione è utilizzabile solo con protocolli monodirezionali.

8.14.6.4 Linea RS-485 TX/RX bidirezionale

Questa impostazione permette di ottenere una comunicazione bidirezionale half-duplex sulla linea RS-485-1.

La linea seriale RS-485-2 non è utilizzata.

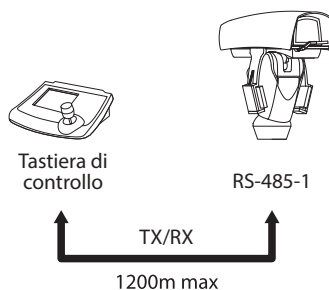





Fig. 75

i Questa funzione è disponibile soltanto con protocolli bidirezionali (esempio: PELCO, AMERICAN DYNAMICS, VIDEOTEC MACRO, ecc.).

9 Accensione

 **Assicurarsi che l'unità e gli altri componenti dell'impianto siano chiusi in modo idoneo a impedire il contatto con componenti sotto tensione.**

 **Durante il normale funzionamento la superficie dell'illuminatore può raggiungere temperature elevate. Evitare il contatto diretto e posizionare l'apparecchiatura in luogo non accessibile al personale non autorizzato. Per qualunque operazione di manutenzione spegnere il dispositivo d'illuminazione e lasciarlo raffreddare per almeno 10 minuti.**

 **Non sostare nei pressi del dispositivo quando alimentato. Agire sul dispositivo solo in assenza di alimentazione.**

 **Accertarsi che tutte le parti siano fissate in maniera solida ed affidabile.**

 **La procedura di preriscaldamento automatico (De-Ice) si potrebbe attivare tutte le volte che il dispositivo viene acceso ad una temperatura ambiente inferiore a 0°C. La procedura serve a garantire la corretta funzionalità del dispositivo anche alle basse temperature. La durata varia a seconda delle condizioni climatiche (da 60 minuti fino a 105 minuti).**

Collegare l'alimentazione elettrica per accendere l'unità.

Scollegare l'alimentazione elettrica per spegnere l'unità.

9.1 Prima accensione

Alla prima accensione è sempre utile verificare la corretta configurazione del dispositivo.

Prima di fornire alimentazione, rimuovere lo sportellino di protezione dei DIP e posizionare su ON la levetta dello switch di aggiornamento del firmware (8.14.2 Configurazione del DIP1, pagina 34).

Alimentare il dispositivo. Dopo pochi secondi sarà possibile verificare a monitor la configurazione impostata.

Conclusa la verifica, spegnere il dispositivo e abbassare nuovamente la levetta dello switch di aggiornamento del firmware.

Chiudere lo sportellino ed alimentare di nuovo il dispositivo.

9.2 Lista dei controlli

 **Se uno dei controlli non supera il test (ERR), contattare il centro assistenza. La scritta OFF significa che il brandeggio non è provvisto dell'opzione descritta.**

Durante la fase di accensione il dispositivo visualizza la lista dei controlli che deve effettuare prima di passare al funzionamento normale.

STARTUP	

TEST FLASH	: OK
HOMING PROCEDURE	: OK
ZFI SEARCH	: OK
IO EXPANDER	: OFF
IR360 STATE	: OFF

Fig. 76

10 Configurazione

10.1 Interfaccia OSM (On Screen Menu)

10.1.1 Uso dell'OSM

Durante il normale funzionamento dell'unità è possibile attivare l'OSM per la selezione e la configurazione delle funzioni avanzate. Per ulteriori informazioni fare riferimento al manuale della tastiera utilizzata e al relativo capitolo (12.11 Comandi speciali, pagina 56).

Uscire dall'OSM con Zoom Wide (Zoom-).

i Il menù si autoconfigura dinamicamente a seconda del modello di brandeggio.

10.1.1.1 Come usare il joystick

Tutte le operazioni nei menù sono eseguite utilizzando il joystick.

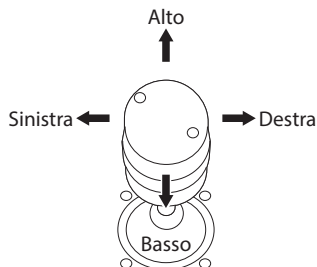

Fig. 77 Pan e tilt.

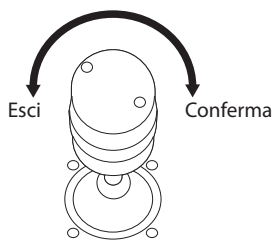

Fig. 78 Zoom Wide e Zoom Tele.

i Nel caso si usino tastiere di controllo con joystick a due assi, utilizzare i pulsanti di Zoom Wide e Zoom Tele per inviare i comandi Esci e Conferma.

10.1.1.2 Come muoversi nei menù

Ogni videata dell'OSM presenta una lista di parametri o di sottomenù che possono essere selezionati dall'operatore. Per scorrere i vari parametri muovere il cursore agendo sul joystick (alto e basso).

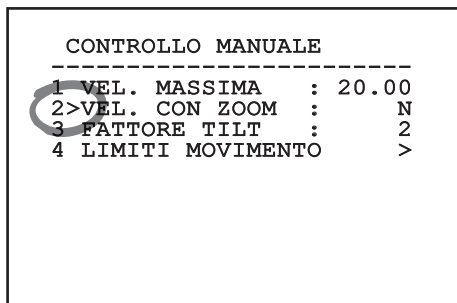

Fig. 79

Il simbolo > a fine riga indica la presenza di uno specifico sottomenù. Per attivarlo è sufficiente confermare la voce del menù. Per uscire dal sottomenù, usare la funzione Esci (Zoom Wide).

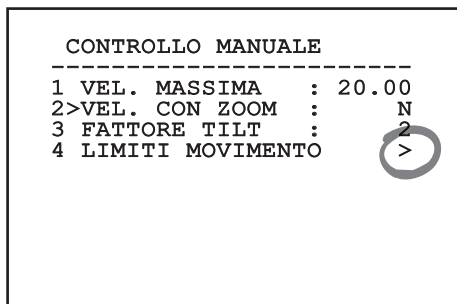

Fig. 80

10.1.1.3 Come modificare i parametri

Spostarsi con il cursore in corrispondenza del parametro che si intende modificare e confermare. Il campo comincerà a lampeggiare indicando che è in modifica. Agendo con il joystick (alto e basso) saranno mostrate le possibili scelte.

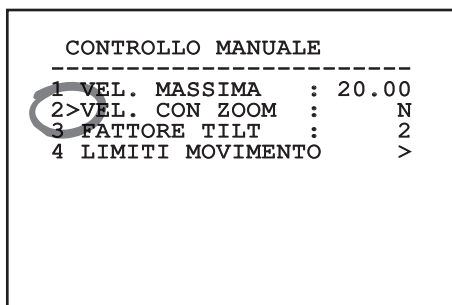

Fig. 81

Individuata l'opzione desiderata, confermare.

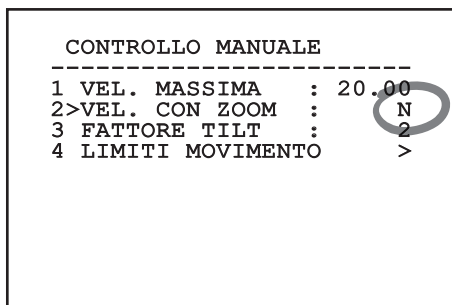

Fig. 82

Il campo smetterà di lampeggiare a conferma della preferenza.

10.1.1.4 Come modificare i campi numerici

Spostarsi con il cursore in corrispondenza del parametro che si intende modificare e confermare.

```

MODIFICA PRESET
-----
1 NR.      :      1
2 ENAB.   :      N
3>PAN     : +  0.00
4 TILT    : - 40.00
5 VEL.    :  20.00
6 PAUSA   :      5
7 TESTO:  PRESET 001
8 VAI A  PRESET?
  
```

Fig. 83

La prima cifra del campo numerico in modifica lampeggia e l'ultima riga dello schermo mostra i limiti di accettazione del campo. Muoversi sul campo (sinistra e destra) e cambiare il segno oppure il valore numerico (alto e basso).

```

MODIFICA PRESET
-----
1 NR.      :      1
2 ENAB.   :      N
3>PAN     : +000.00
4 TILT    : - 40.00
5 VEL.    :  20.00
6 PAUSA   :      5
7 TESTO:  PRESET 001
8 VAI A  PRESET?

min:-180.00 max:+179.99
  
```

Fig. 84

A risultato ottenuto confermare. Il cursore ritorna a sinistra e la cifra modificata smetterà di lampeggiare. Il campo sarà forzato al valore minimo o al massimo consentito se si tenta di inserire un valore non previsto.

10.1.1.5 Come modificare i testi

Spostarsi con il cursore in corrispondenza del parametro che si intende modificare e confermare.

```

MODIFICA AREA
-----
1 NR      :      1
2 START:+ 0.00
3 STOP :+  0.00
4>TESTO:TXT AREA1
  
```

Fig. 85

Apparirà la schermata di modifica del testo. Il simbolo freccia si posiziona sotto il carattere modificabile mentre il cursore > si posiziona alla sinistra del carattere selezionato.

```

EDIT TEXT: AREA
-----
Text: TEXT AREA1
      ↑
>A B C D E F G   ERASE
  H I J K L M N   SAVE
   O P Q R S T U   EXIT
   V W X Y Z 0 1   abc
  2 3 4 5 6 7 8
  9 : ; . , ? !
   \ + - * / = "
  < > SPACE ← →
  
```

Fig. 86

È possibile navigare all'interno del menù usando il joystick.

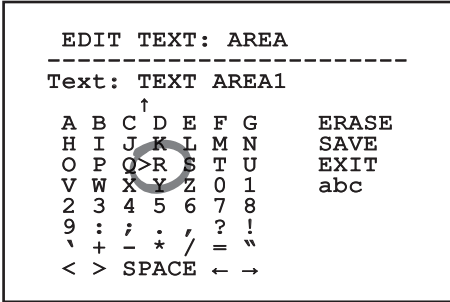

Fig. 87

Il comando Conferma (Zoom Tele) inserisce il carattere desiderato.

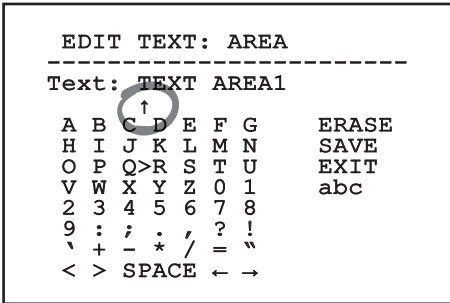

Fig. 88

Usare:

- **ERASE:** Cancella l'intera stringa di testo.
- **SAVE:** Salva il nuovo testo prima di uscire dal menù.
- **EXIT:** Esce dal menù.
- **abc:** Visualizza i caratteri minuscoli.

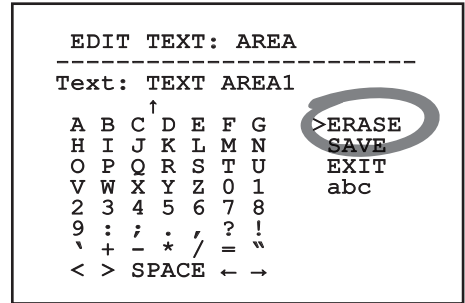

Fig. 89

Per uscire dal menù è possibile usare anche il comando Zoom Wide.

10.1.2 Configurazione tramite OSM

Di seguito verranno illustrate le schermate che servono a configurare il prodotto.

10.1.3 Menù Principale

Dal menù principale è possibile accedere alla configurazione del dispositivo.

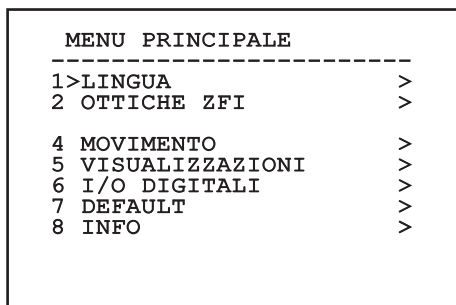

Fig. 90

Il menù si autoconfigura dinamicamente a seconda del modello di brandeggio.

10.1.4 Menù Scelta Lingua

Il menù permette di selezionare la lingua desiderata.

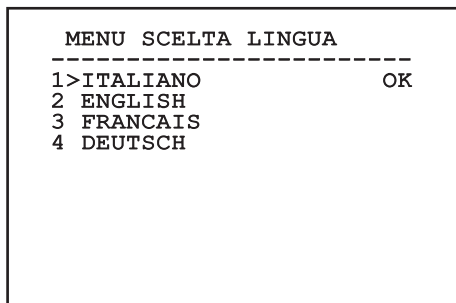

Fig. 91

10.1.5 Menù Parametri ZFI

- Zoom:** Imposta il numero massimo di ingrandimenti che può effettuare l'ottica motorizzata.
- Filo Comune:** Se abilitato, gestisce le ottiche motorizzate a filo comune altrimenti quelle ad inversione di polarità.
- Sonda IR:** Segnala l'eventuale presenza di un interruttore crepuscolare per la gestione Day/Night dell'ottica motorizzata. Sono disponibili tre opzioni:
 - Off: Commutazione Day/Night non abilitata.
 - Interna: L'interruttore crepuscolare per la commutazione Day/Night si trova all'interno degli illuminatori.
 - Esterna: L'interruttore crepuscolare per la commutazione Day/Night va collegato al morsetto LNO.
- Titolazione Aree:** Permette di entrare nel sottomenù per la gestione della titolazione delle aree.
- Mascheratura Aree:** Permette di entrare nel sottomenù per la gestione della mascheratura delle aree.
- Seriale Custodia:** Permette di entrare nel sottomenù per la gestione della porta seriale della custodia.
- Polarità:** Permette di entrare nel sottomenù per la gestione della polarità dei motori di Zoom, Focus ed Iris.

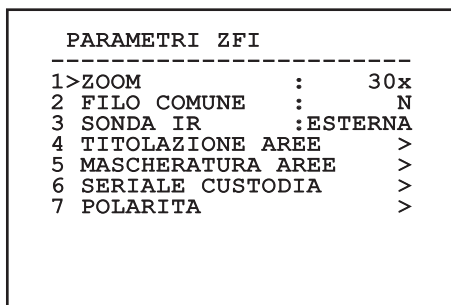

Fig. 92

10.1.5.1 Menù Titolazione Aree

Questa funzione consente di impostare fino a otto zone (di dimensioni variabili) con possibilità di titolazione.

Permette di configurare i seguenti parametri:

Numero: Seleziona l'area da modificare.

Abilitazione: Abilita la visualizzazione sullo schermo del messaggio associato all'area raggiunta.

Start: Imposta la posizione iniziale dell'area.

Stop: Imposta la posizione finale dell'area

Testo: Modifica il testo che viene visualizzato quando ci si muove all'interno dell'area.

TITOLAZIONE AREE			

1	>NR.	:	1
2	ENAB.	:	N
3	START:	+	0.00
4	STOP	:	+ 0.00
5	TESTO:		ZONE 1

Fig. 93

Esempio: Per attivare la titolazione dell'area 1 quando il dispositivo si trova tra +15° e +45° è necessario:

- Abilitare la titolazione delle aree, impostando S come valore della voce Abilitazione.
- Selezionare 1 come valore del parametro Nr.
- Impostare +015.00 come valore del parametro Start.
- Impostare +045.00 come valore del parametro Stop.
- Se necessario, modificare il testo visualizzato selezionando la voce Testo.

i Ponendo a zero i valori di Start e Stop del menù si disabilita la visualizzazione della scritta. In caso di sovrapposizione di più aree prevale quella con numero inferiore.

i Definire le aree muovendosi in senso orario come illustrato in figura.

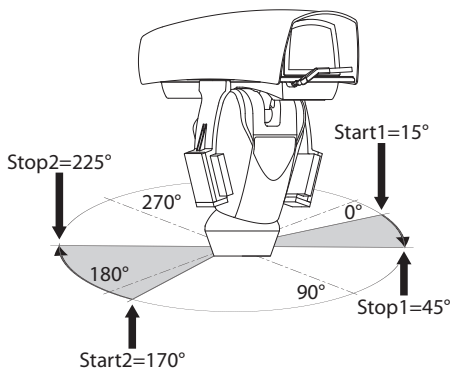

Fig. 94

10.1.5.2 Menù Mascheratura Aree

Questa funzione consente di impostare fino a otto maschere (di dimensioni variabili) con possibilità di titolazione.

1. **Numero:** Seleziona l'area da modificare.
2. **Enabling:** Abilita la mascheratura dell'area raggiunta.
3. **Start:** Imposta la posizione iniziale dell'area.
4. **Stop:** Imposta la posizione finale dell'area.
5. **Testo:** Modifica il testo che viene visualizzato quando l'area è attiva.

MASCHERATURA AREE

```

-----
1 >NR      :      1
2 ENAB.   :      N
3 START: + 0.00
4 STOP : + 0.00
5 TESTO: MASK 1
  
```

Fig. 95

Esempio: Per attivare la mascheratura dell'area 1 quando il dispositivo si trova tra $+15^\circ$ e $+45^\circ$ è necessario:

- Selezionare 1 come valore del parametro Nr.
- Abilitare la mascheratura dell'area, impostando S come valore della voce Abilitazione.
- Impostare $+015.00$ come valore del parametro Start.
- Impostare $+045.00$ come valore del parametro Stop.
- Se necessario, modificare il testo visualizzato selezionando la voce Testo.

i Ponendo a zero i valori di Start e Stop del menù si disabilita la mascheratura. In caso di sovrapposizione di più maschere prevale quella con numero inferiore.

i Definire le maschere muovendosi in senso orario come illustrato in figura.

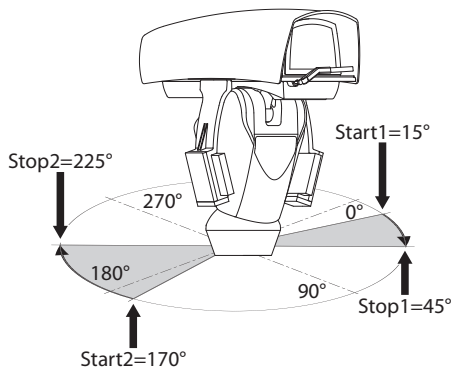

Fig. 96

10.1.6 Menù Seriale Custodia

i Una volta usciti dall'OSM della telecamera, premere il tasto Iris Close per tornare all'OSM del brandeggio.

i Per evitare la sovrapposizione dell'OSM della telecamera con l'OSM del brandeggio, è necessario uscire dalla modalità di configurazione della telecamera prima di premere il tasto Iris Close.

1. **Protocollo:** Permette di scegliere il protocollo usato nella seriale della custodia.
2. **Baud Rate:** Permette di scegliere il baud rate usato nella seriale della custodia.
3. **Cmd Invio:** Sostituisce il comando Conferma inviato tramite joystick con uno personalizzato.
4. **Cmd Esci:** Sostituisce il comando Esci inviato tramite joystick con uno personalizzato.
5. **Abilita OSM Camera:** Permette di entrare nella modalità di configurazione della telecamera.

```

SERIALE CUSTODIA
-----
1>PROTOCOLLO:      NESSUNO
2 BAUDRATE   :      9600
3 CMD INVIO  : IRIS CLOSE
4 CMD ESCI   : IRIS OPEN
5 ABILITA OSM CAMERA >
    
```

Fig. 97

10.1.7 Menù Polarità

Permette di configurare i seguenti parametri:

1. **Zoom:** Permette di scegliere la polarità di rotazione del motore dello Zoom dell'ottica.
2. **Focus:** Permette di selezionare la polarità di rotazione del motore del Focus dell'ottica.
3. **Iris:** Permette di selezionare la polarità di rotazione del motore dell'Iris dell'ottica.

```

POLARITA
-----
1>ZOOM :      POSITIVA
2 FOCUS :      POSITIVA
3 IRIS  :      POSITIVA
    
```

Fig. 98

10.1.8 Menù Movimento

1. **Offset Pan:** Il brandeggio ha una posizione di 0° definita meccanicamente. La funzione Offset Pan permette di definire via software una diversa posizione di 0°.
2. **Controllo Manuale:** Permette di accedere ai sottomenù che gestiscono i parametri associati ai movimenti manuali del dispositivo.
3. **Preset:** Permette di accedere ai sottomenù che consentono di modificare i valori dei Preset.
4. **Patrol:** Permette di accedere ai sottomenù che consentono di modificare i valori del Patrol.
5. **Autopan:** Permette di accedere ai sottomenù che consentono di modificare i valori dell'Autopan.
6. **Richiamo Movimenti:** Permette di accedere al sottomenù che gestisce il richiamo automatico dei movimenti.

```

MOVIMENTO
-----
1>OFFSET PAN:      + 20.00
2 CONTROLLO MANUALE >
3 PRESET           >
4 PATROL           >
5 AUTOPAN          >
6 RICHIAMO MOVIMENTI >

```

Fig. 99

10.1.8.1 Menù Controllo Manuale

1. **Velocità Massima:** Selezione della massima velocità manuale.
2. **Velocità Con Zoom:** Tale parametro, se abilitato, riduce automaticamente la velocità di Pan e Tilt in funzione del fattore di Zoom.
3. **Fattore Tilt:** Selezione del fattore di riduzione della velocità manuale dell'asse tilt.
4. **Limiti Movimento:** Accesso al menù Limiti.

```

CONTROLLO MANUALE
-----
1>VEL. MASSIMA      : 20.00
2 VEL. CON ZOOM     :      N
3 FATTORE TILT      :       2
4 LIMITI MOVIMENTO  >

```

Fig. 100

10.1.8.2 Menù Controllo Manuale (Limiti)

Permette di configurare i seguenti parametri:

1. **Limiti Pan:** Abilita i limiti del Pan.
2. **Pan Inizio:** Imposta il limite iniziale del Pan.
3. **Pan Fine:** Imposta il limite finale del Pan.
4. **Tilt Inizio:** Imposta il limite iniziale del Tilt.
5. **Tilt Fine:** Imposta il limite finale del Tilt.

```

LIMITI
-----
1>LIMITI PAN      :          N
2 PAN INIZIO     : +   0.00
3 PAN FINE       : +   0.00
4 TILT INIZIO    : +   0.00
5 TILT FINE      : +   0.00
    
```

Fig. 101

Il menù si autoconfigura dinamicamente in funzione della scelta effettuata mostrando i parametri sui quali si può agire.

10.1.8.3 Menù Preset

1. **Modifica Preset:** Per accedere al menù Modifica Preset.
2. **Utilità Preset:** Per accedere al menù Utilità Preset.

```

PRESET
-----
1>MODIFICA PRESET  >
2 UTILITA' PRESET  >
    
```

Fig. 102

10.1.8.4 Menù Preset (Modifica Preset)

Permette di configurare i seguenti parametri:

1. **Numero:** Il numero del Preset che si desidera modificare.
2. **Abilitazione:** L'abilitazione del preset.
3. **Pan:** Posizione di pan espressa in gradi.
4. **Tilt:** Posizione del tilt espressa in gradi.
5. **Velocità:** La velocità di raggiungimento della posizione quando il preset viene richiamato dalle funzioni Patrol e Autopan.
6. **Pausa:** L'attesa in secondi prima di iniziare il successivo movimento in Patrol.
7. **Testo:** La scritta visualizzata quando si raggiunge la posizione di preset.
8. **Vai A Preset?:** Impone al brandeggio il raggiungimento della posizione di Preset selezionata.
9. **Abilita Movimenti:** Permette di scegliere una nuova inquadratura.

```

MODIFICA PRESET
-----
1>NR.      :          1
2 ENAB.    :          N
3 PAN      : +   0.00
4 TILT     : -  40.00
5 VEL.     :  20.00
6 PAUSA    :          5
7 TESTO:   PRESET 001
8 VAI A PRESET?
9 ABILITA MOVIMENTI      >
    
```

Fig. 103

Dal menù è possibile memorizzare direttamente i preset inviando il comando Iris Close che abilita i movimenti del brandeggio.

10.1.8.5 Menù Preset (Utilità Preset)

Permette di configurare i seguenti parametri:

1. **Velocità Scan:** Velocità usata per raggiungere la posizione di Preset dopo la ricezione di un comando di Scan.
2. **Velocità Default:** Velocità di default dei Preset. Tale valore è utilizzato dalla funzione Imponi Pausa Vel.? per assegnare a tutti i Preset la stessa velocità.
3. **Pausa Default:** Pausa di default dei Preset. Tale valore è utilizzato dalla funzione Imponi Pausa? per assegnare a tutti i Preset la stessa pausa.
4. **Valore Rampa:** I tempi di partenza e di arresto. A numero maggiore, corrisponde maggiore accelerazione/decelerazione nelle fasi di partenza/arresto.
5. **Imponi Velocità?:** Assegna a tutti i Preset la velocità di default.
6. **Imponi Pausa?:** Assegna a tutti i Preset la pausa di default.

```

UTILITA  PRESET
-----
1>VELOCITA  SCAN  : 20.00
2  VEL.  DEFAULT  : 10.00
3  PAUSA  DEFAULT  :    3
4  VALORE  RAMPA   :   12
5  IMPONI  VEL.?
6  IMPONI  PAUSA?
  
```

Fig. 104

10.1.8.6 Menù Patrol

1. **Primo Preset:** Primo preset della sequenza di Patrol.
2. **Ultimo Preset:** L'ultimo preset della sequenza di Patrol.
3. **Modo Random:** Abilita l'esecuzione in modo casuale. La sequenza viene ricalcolata continuamente.

```

PATROL
-----
1>PRIMO PRESET   :    1
2  ULTIMO PRESET : 250
3  MODO  RANDOM  :    N
  
```

Fig. 105

10.1.8.7 Menù Autopan

1. **Preset Andata:** Posizione iniziale dell'Autopan.
2. **Preset Ritorno:** Posizione finale dell'Autopan.

```

AUTOPAN
-----
1>PRESET ANDATA  :    1
2  PRESET RITORNO:    2
  
```

Fig. 106



La velocità di raggiungimento delle posizioni di Preset è definita nel relativo capitolo (10.1.8.4 Menù Preset (Modifica Preset), pagina 47).

10.1.8.8 Menù Richiamo Movimenti

È possibile configurare l'unità in modo che, dopo un certo periodo di inattività, esegua automaticamente una funzione di movimento scelta dall'operatore.

1. **Tipo Movimento:** Tipo di movimento da richiamare (None, Home, Autopan, Patrol).
2. **Ritardo Movimento:** Tempo di inattività del Joystick, espresso in secondi.

```

RICHIAMO MOVIMENTI
-----
1>TIPO MOVIMENTO:    NONE
2 RIT. MOVIMENTO:    60
    
```

Fig. 107

10.1.9 Menù Visualizzazioni

1. **Posizione Attuale:** Se posto diverso da OFF, permette di selezionare la modalità con la quale sono visualizzate sullo schermo i valori di Pan, Tilt, Zoom, Focus ed Iris.
2. **Nome Preset:** Se posto diverso da OFF, permette di selezionare la modalità con la quale è visualizzato sullo schermo il testo associato all'ultima posizione di Preset raggiunta. È possibile scegliere una visualizzazione a tempo (1 s, 3 s e 5 s) oppure fissa (Const).
3. **ID Brandeggio:** Se posto diverso da OFF, visualizza l'ID del prodotto.
4. **Allarmi:** Se posto diverso da OFF, permette di selezionare la modalità con la quale sono visualizzati i testi associati ad un allarme. È possibile scegliere una visualizzazione a tempo (1 s, 3 s e 5 s) oppure fissa (Const).

5. **Comandi Ricevuti:** Permette di abilitare la visualizzazione dei comandi seriali ricevuti.
6. **Delta Orizzontale:** Spostamento orizzontale dei testi dei menù per consentire una migliore centratura.
7. **Delta Verticale:** Spostamento verticale dei testi dei menù per consentire una migliore centratura.
8. **Segnale Video:** Formato del segnale video.

```

VISUALIZZAZIONI
-----
1 POS. ATTUALE      :  ON
2 NOME PRESET      :  5 S
3 ID BRANDEGGIO    :  ON
4 ALLARMI          :  ON
5 COMANDI RICEVUTI :  ON
6 DELTA ORIZ.     :  35
7 DELTA VERTICALE  :  10
8 SEGNALE VIDEO    :  PAL
    
```

Fig. 108

Il menù si autoconfigura dinamicamente a seconda del modello di brandeggio.

10.1.10 Menù I/O Digitali-Opzioni

1. **Allarmi:** Accesso al menù Allarmi.
2. **Impianto Di Lavaggio:** Accesso al menù Impianto di Lavaggio.
3. **Comunicazioni:** Accesso al menù Comunicazioni.

```

I/O DIGITALI-OPZIONI
-----
1>ALLARMI           >
2 IMPIANTO DI LAVAGGIO >
3 COMUNICAZIONI    >
    
```

Fig. 109

10.1.10.1 Menù Allarmi

- 01-04. **Allarmi 1-4:** Accesso ai menù in cui è possibile modificare i parametri degli Allarmi da 1 a 4.
05. **Stato Allarmi:** Accesso al menù Stato Allarmi.

```

ALLARMI
-----
1>ALLARME 1          >
2 ALLARME 2          >
3 ALLARME 3          >
4 ALLARME 4          >
5 STATO ALLARMI     >
  
```

Fig. 110

Il menù si autoconfigura dinamicamente a seconda del modello di brandeggio.

Nei menù dei singoli allarmi è possibile configurare i seguenti valori:

1. **Tipo:** Tipo di contatto, normalmente chiuso (N.C.) o normalmente aperto (N.O.)
2. **Azione:** Il tipo di azione che il brandeggio effettua quando l'allarme si attiva (Off, Msg, PTZ Stop, Wiper, Washer, Scan, Patrol, Autopan, Relay, Ir Filt). Il parametro OFF disabilita l'allarme.
3. **Numero:** Il preset da raggiungere quando il tipo di azione dell'allarme è Scan.
4. **Testo:** Il messaggio visualizzato quando l'allarme è attivo.

```

ALLARME 1
-----
1>TIPO :      N.C.
2 AZ.  :      SCAN
3 NR.  :      1
4 TESTO: ALARM 1
  
```

Fig. 111

Il menù si autoconfigura dinamicamente in funzione della scelta effettuata mostrando i parametri sui quali si può agire.

Nel menù Stato Allarmi è visualizzato lo stato dell'ingresso degli allarmi (Closed, Open).

```

STATO ALLARMI
-----
ALLARME 1          CLOSED
ALLARME 2          OPEN
ALLARME 3          CLOSED
ALLARME 4          CLOSED
  
```

Fig. 112

10.1.10.2 Menù Comunicazioni

1. **ACK Seriale:** Configura il brandeggio per abilitare/disabilitare l'invio di una risposta con ACK ai comandi seriali.
2. **ACK PELCO D Standard:** Configura l'ACK di risposta del comando PELCO D. Il menù è invisibile se il protocollo di comunicazione impostato dai DIP switch non è PELCO D o se l'ACK di risposta non è abilitato (ACK SERIALE = FALSE). Se la voce del menù è abilitata, l'ACK di risposta è di tipo standard (checksum correlato al messaggio originale). Se la voce del menù è disabilitata, il checksum viene calcolato solamente sul pacchetto di ACK stesso.

```

COMUNICAZIONI
-----
1 ACK SERIALE      : S
2 ACK PELCOD STANDARD: N
  
```

Fig. 113

10.1.10.3 Menù Impianto di Lavaggio

L'unità offre la possibilità di utilizzare un tergicristallo e di azionare una pompa per la pulizia del vetro.

Per configurare l'impianto di lavaggio posizionare l'obiettivo della telecamera di fronte all'ugello dell'impianto di lavaggio.

Salvare un preset (XY) per questa posizione, che sarà richiamato dal brandeggio quando si attiva la funzione Washer.

Configurare i seguenti parametri:

1. **Abilita:** Abilitazione della funzione Washer.
2. **Preset Ugello:** Inserire il numero del preset (XY) corrispondente all'ugello.
3. **Ritardo Tergi On:** Selezionare l'intervallo di tempo che passa tra l'attivazione della pompa e quella del tergicristallo.
4. **Durata Lavaggio:** Scegliere la durata dello spazzolamento.
5. **Ritardo Tergi Off:** Scegliere la durata dello spazzolamento senza acqua.

```

IMPIANTO DI LAVAGGIO
-----
1>ABILITA           : N
2 PRESET UGELLO     : 1
3 RITARDO TERGI ON  : 5
4 DURATA LAVAGGIO   : 10
5 RITARDO TERGI OFF : 5
    
```

Fig. 114

10.1.11 Menù Default

1. **Cancella Setup?:** Ripristina tutti i parametri eccetto i preset.
2. **Cancella Preset?:** Elimina tutti i preset precedentemente memorizzati.

```

DEFAULT
-----
1>CANCELLA SETUP?
2 CANCELLA PRESET?
    
```

Fig. 115

 **Le operazioni sopra descritte comportano la perdita di tutti i dati precedentemente memorizzati (es.: Preset, Patrol, Autopan, Home...).**

10.1.12 Menù Info

Il menù consente di verificare la configurazione del dispositivo e la versione di firmware installata.

```

INFO
-----
Device ID: 00001
Type      : Rs485 only Rx
Baud Rate: 38400-8N1
Protocol  : MACRO
Net Board: Fw6.02 Hw01
Mpp Board: Fw6.02 Hw00
Config.   : 001
P.C.      : UPT1SVSA000E
S.N.      : 000000000000
Upgrade   : NET BOARD
    
```

Fig. 116

11 Accessori



Per ulteriori dettagli sulla configurazione e l'utilizzo fare riferimento al manuale del relativo accessorio.

11.1 Impianto di lavaggio

Il brandeggio può essere dotato di una pompa esterna che fornisce acqua per la pulizia del vetro.

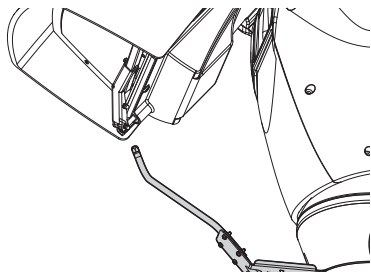

Fig. 117

11.1.1 Collegamento dell'impianto di lavaggio



ATTENZIONE! L'installazione è di tipo TNV-1. Non collegare a circuiti SELV.



ATTENZIONE! Per ridurre il rischio di incendio usare solamente cavi certificati UL Listed o CSA aventi sezioni maggiori o uguali a 0.14mm^2 (26AWG).



Tutti i cavi di segnale devono essere raggruppati con una fascetta.

COLLEGAMENTO DELL'IMPIANTO DI LAVAGGIO	
Morsetti	Descrizione
AL1-COM AL1-AGND	Ingresso di allarme. Gli impianti di lavaggio provvisti di sensore di livello, segnalano l'assenza di liquido nel serbatoio.
O1-C1	Contatto pulito per attivazione dell'impianto di lavaggio.

Tab. 17

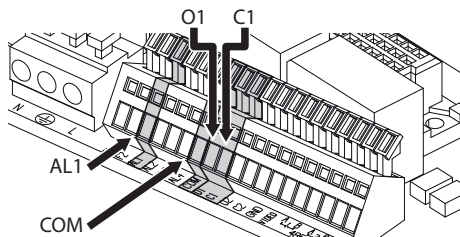

Fig. 118 Versione standard.

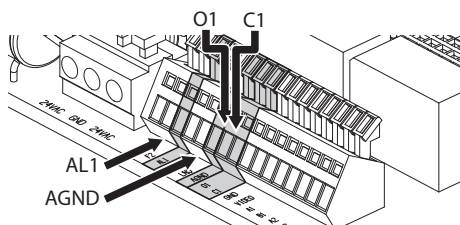

Fig. 119 Versione con illuminatori a LED.



Per ulteriori informazioni fare riferimento al relativo capitolo (10.1.10.3 Menù Impianto di Lavaggio, pagina 51).

11.2 Supporto da parete

Supporto per montaggio a parete con passaggio interno cavi.

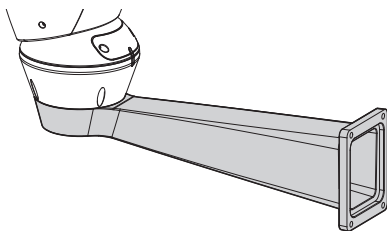

Fig. 120

11.3 Supporto da parapetto

Supporto per montaggio a parapetto con passaggio interno cavi.

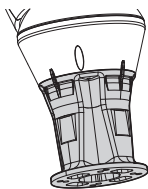

Fig. 121

11.4 Alimentatore con controllo degli illuminatori

Scatola stagna con alimentatore e controllo degli illuminatori.

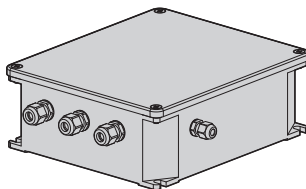

Fig. 122 Versione della scatola standard.

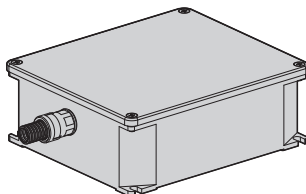

Fig. 123 Versione della scatola certificata UL.



Per ulteriori informazioni fare riferimento al relativo capitolo (8.5.3 Collegamento degli ingressi di allarme, dell'interruttore crepuscolare e dei relè, pagina 26).

12 Istruzioni di funzionamento ordinario

12.1 Visualizzazione dello stato del brandeggio

Durante il normale funzionamento, a scelta dell'utente, il brandeggio visualizza a monitor i dati organizzati come illustrato. La visualizzazione può essere abilitata o disabilitata (10.1.9 Menù Visualizzazioni, pagina 49).

ID 1: Indirizzo del ricevitore;

ZONE 1: Nome dell'area nella quale ci si trova;

MASK 1: Nome della maschera visualizzata;

ALARM 1: Testo dell'ultimo allarme attivo;

Preset 001 go to: Comandi ricevuti via seriale;

E1: PATROL CONFIGURATION: Visualizzazione degli errori riscontrati durante il funzionamento del sistema;

PAN/TILT/Z/F/I: Posizione attuale di PAN, TILT, ZOOM, FOCUS e IRIS;

PRESET 001: Nome del preset selezionato attivo.

```

ID 1

ZONE 1
MASK 1
ALARM1
Preset 001 go to

E1: PATROL CONFIGURATION
PAN : +000.00
TILT: +000.00
Z:000.0 F:000.0 I:000.0
PRESET 001
  
```

Fig. 124

12.2 Salvataggio di un Preset

Tramite il dispositivo di controllo utilizzato è possibile salvare la posizione attuale (per ulteriori informazioni fare riferimento al manuale del dispositivo utilizzato).

12.3 Richiamo di una posizione di Preset (Scan)

Tramite il dispositivo di controllo è possibile richiamare una posizione di Preset precedentemente salvata (per ulteriori informazioni fare riferimento al manuale del dispositivo utilizzato).

12.4 Richiamo della posizione di Home

Tramite il dispositivo di controllo è possibile richiamare la posizione di Home (Scan n.1) precedentemente salvata (per ulteriori informazioni fare riferimento al manuale del dispositivo di controllo utilizzato).

12.5 Attivazione del Patrol

La funzione Patrol richiama in modo sequenziale i preset memorizzati.

Per attivare/disattivare la funzione fare riferimento al manuale del dispositivo di controllo utilizzato o al relativo capitolo (12.11 Comandi speciali, pagina 56).

Per disattivare la funzione muovere il joystick o richiamare un tipo di movimento diverso.

Per la configurazione di questa funzione fare riferimento al relativo capitolo (10.1.8.6 Menù Patrol, pagina 48).

12.6 Attivazione dell'Autopan

La funzione Autopan richiama in modo continuo i 2 preset memorizzati.

Per attivare/disattivare la funzione fare riferimento al manuale del dispositivo di controllo utilizzato o al relativo capitolo (12.11 Comandi speciali, pagina 56).

Per disattivare la funzione muovere il joystick o richiamare un tipo di movimento diverso.

Per la configurazione di questa funzione fare riferimento al relativo capitolo (10.1.8.7 Menù Autopan, pagina 48).

12.7 Attivazione del tergicristallo (Wiper)



Non utilizzare il tergicristallo quando la temperatura esterna è inferiore a 0°C o in presenza di ghiaccio.

Per attivare/disattivare la funzione fare riferimento al manuale del dispositivo di controllo utilizzato o al relativo capitolo (12.11 Comandi speciali, pagina 56).



Il tergicristallo si disattiva in modo automatico se lasciato acceso.

12.8 Attivazione dell'impianto di lavaggio (Washer)

Quando si invia il comando il brandeggio si posiziona con la finestra di fronte all'ugello. Si attivano la pompa ed il tergicristallo per un tempo determinato. Alla fine della procedura il brandeggio ritorna nella posizione iniziale.

Per attivare/disattivare la funzione fare riferimento al manuale del dispositivo di controllo utilizzato o al relativo capitolo (12.11 Comandi speciali, pagina 56).

Per attivare le configurazioni speciali fare riferimento al relativo capitolo (12.12 Configurazioni speciali, pagina 57).

I modelli con impianto di lavaggio provvisto di sensore di livello visualizzano un messaggio a video quando il liquido nel serbatoio è insufficiente.

12.9 Attivazione dell'illuminatore a LED

Se l'impianto non è munito di interruttore crepuscolare è possibile attivare/disattivare l'illuminatore a LED tramite l'apposito comando (12.11 Comandi speciali, pagina 56).

12.10 Reboot dell'unità

Tramite il dispositivo di controllo è possibile inviare il comando di riavvio dell'unità (per ulteriori informazioni fare riferimento al manuale del dispositivo di controllo utilizzato).

Per ulteriori informazioni fare riferimento al relativo capitolo (12.11 Comandi speciali, pagina 56).

12.11 Comandi speciali

COMANDI SPECIALI						
Azione	Comando					
	Protocollo					
	AMERICAN DYNAMICS	ERNITEC	PANASONIC	PELCO D	VIDEOTEC MACRO	VISTA
Wiper Start	Salvare Preset 85	Salvare Preset 85	Salvare Preset 85	Salvare Preset 85	Salvare Preset 85	Salvare Preset 85
	Aux 3 ON	Aux 3 ON	Salvare Preset 54	Aux 3 ON	Aux 3 ON	Aux 3 ON
					Wip+	
Wiper Stop	Salvare Preset 86	Salvare Preset 86	Salvare Preset 86	Salvare Preset 86	Salvare Preset 86	Salvare Preset 86
	Aux 3 OFF	Aux 3 OFF	Salvare Preset 55	Aux 3 OFF	Aux 3 OFF	Aux 3 OFF
					Wip-	
Washer Start	Salvare Preset 87	Salvare Preset 87	Salvare Preset 87	Salvare Preset 87	Salvare Preset 87	Salvare Preset 87
	Aux 4 ON	Aux 4 ON	Salvare Preset 56	Aux 4 ON	Aux 4 ON	Aux 4 ON
					Was+	
Modalità Notturna On	Salvare Preset 88	Salvare Preset 88	Salvare Preset 88	Salvare Preset 88	Salvare Preset 88	Salvare Preset 88
			Salvare Preset 57			
Modalità Notturna Off	Salvare Preset 89	Salvare Preset 89	Salvare Preset 89	Salvare Preset 89	Salvare Preset 89	Salvare Preset 89
			Salvare Preset 58			
Patrol Stop	Salvare Preset 92	Salvare Preset 92	Salvare Preset 92	Salvare Preset 92	Salvare Preset 92	Salvare Preset 92
	Joystick	Joystick	Joystick	Joystick	Joystick	Joystick
			Salvare Preset 59		Pat-	
Patrol Start	Salvare Preset 93	Salvare Preset 93	Salvare Preset 93	Salvare Preset 93	Salvare Preset 93	Salvare Preset 93
	Attiva pattern 1	Attiva patrol	Salvare Preset 60	Pattern	Pat+	Attiva Patrol
Reboot dispositivo	Salvare Preset 94	Salvare Preset 94	Salvare Preset 94	Salvare Preset 94	Salvare Preset 94	Salvare Preset 94
	Faster+ Zoom out+ Focus far+ Iris open		Salvare Preset 61		Ini+	
Attivazione OSM	Salvare Preset 95	Salvare Preset 95	Salvare Preset 95	Salvare Preset 95	Salvare Preset 95	Salvare Preset 95
	Iris open+ Focus+ Zoom out		Salvare Preset 46		Men+	
Autopan Stop	Salvare Preset 96	Salvare Preset 96	Salvare Preset 96	Salvare Preset 96	Salvare Preset 96	Salvare Preset 96
	Joystick	Joystick	Joystick	Joystick	Joystick	Joystick
			Salvare Preset 62		Apa-	
Autopan Start	Salvare Preset 99	Salvare Preset 99	Salvare Preset 99	Salvare Preset 99	Salvare Preset 99	Salvare Preset 99
	Attiva Pattern 2	Attiva Autopan	Salvare Preset 63	Pattern 1	Apa+	Attiva Autopan

Tab. 18

12.12 Configurazioni speciali

CONFIGURAZIONI SPECIALI					
Configurazione	Protocollo				
	AMERICAN DYNAMICS	PANASONIC	PELCO D	VIDEOTEC MACRO	VISTA
Washer Configurazione 1 (lavaggio corto)	Salvare Preset 72	Salvare Preset 72	Salvare Preset 72	Salvare Preset 72	Salvare Preset 72
Washer Configurazione 2 (lavaggio lungo)	Salvare Preset 73	Salvare Preset 73	Salvare Preset 73	Salvare Preset 73	Salvare Preset 73

Tab. 19

13 Manutenzione



La manutenzione deve essere eseguita solo da personale qualificato ad intervenire su circuiti elettrici.

13.1 Sostituzione dei fusibili



Eeguire la manutenzione in assenza di alimentazione e con il dispositivo di sezionamento aperto.

In caso di necessità sostituire i fusibili illustrati in figura (8.3 Descrizione della scheda connettori, pagina 21).

SOSTITUZIONE DEI FUSIBILI		
Tensione	Fusibile F1	Fusibile F2
24Vac, 50/60Hz	T 4A L 250V 5x20	T 6.3A H 250V 5x20 (versione standard)
		T 8A H 250V 5x20 (versione con illuminatori a LED)
120Vac, 50/60Hz	T 4A L 250V 5x20	T 4A H 250V 5x20
230Vac, 50/60Hz	T 4A L 250V 5x20	T 2A H 250V 5x20

Tab. 20

14 Pulizia

14.1 Pulizia del vetro e delle parti in plastica



Evitare alcool etilico, solventi, idrocarburi idrogenati, acidi forti e alcali. L'utilizzo di detti prodotti danneggia in modo irreparabile la superficie trattata.

Si consiglia di utilizzare un panno morbido con saponi neutri diluiti con acqua o prodotti specifici per la pulizia delle lenti degli occhiali.

14.2 Pulizia della finestra in germanio



Pulire la finestra prestando attenzione a non graffiare o rigare la superficie esterna trattata con carbon coating. Danneggiando tale rivestimento c'è il rischio di compromettere la trasparenza all'infrarosso della superficie.

La pulizia deve essere effettuata con sapone neutro diluito con acqua.

15 Smaltimento dei rifiuti



Questo simbolo e il sistema di riciclaggio sono validi solo nei paesi dell'EU e TMovano applicazione in altri paesi del mondo.

Il vostro prodotto è costruito con materiali e componenti di alta qualità, che sono riutilizzabili o riciclabili.

Prodotti elettrici ed elettronici che riportano questo simbolo, alla fine dell'uso, devono essere smaltiti separatamente dai rifiuti casalinghi.

Vi preghiamo di smaltire questo apparecchio in un Centro di raccolta o in un'Ecostazione.

Nell'Unione Europea esistono sistemi di raccolta differenziata per prodotti elettrici ed elettronici.

16 Risoluzione dei problemi

Richiedere l'intervento di personale qualificato quando:

- L'unità si è danneggiata a seguito di una caduta;
- Le prestazioni dell'unità hanno avuto un evidente peggioramento;
- L'unità non funziona correttamente anche se sono state seguite tutte le indicazioni riportate nel presente manuale.

PROBLEMA	Il prodotto non si accende.
CAUSA	Errato cablaggio, rottura dei fusibili.
SOLUZIONE	Verificare la corretta esecuzione delle connessioni. Verificare la continuità dei fusibili e, in caso di guasto, sostituirli con i modelli indicati.

PROBLEMA	Con particolari condizioni di zoom c'è interferenza della custodia o del tettuccio nell'immagine ripresa (solo per versioni con ottica motorizzata).
CAUSA	Posizione della telecamera o dell'ottica troppo arretrata rispetto alla finestra.
SOLUZIONE	Regolare la posizione della telecamera e dell'ottica.

PROBLEMA	Non compare l'immagine ripresa, ma una schermata blu con l'indicazione: No Video Signal!!!.
CAUSA	Errato cablaggio della telecamera o telecamera guasta.
SOLUZIONE	Verificare la corretta esecuzione delle connessioni.

PROBLEMA	Durante l'accensione il brandeggio rimane bloccato visualizzando una schermata del tipo:
-----------------	---

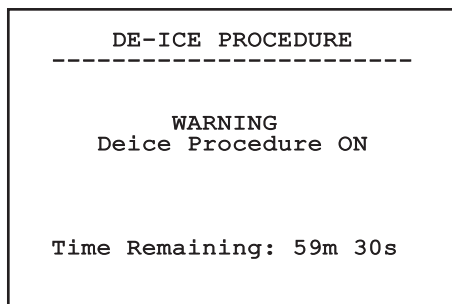

CAUSA	La temperatura ambiente è molto bassa.
SOLUZIONE	Attendere il termine della procedura di preriscaldamento. Se la temperatura ambiente è troppo bassa il brandeggio rimane bloccato visualizzando la seguente schermata:

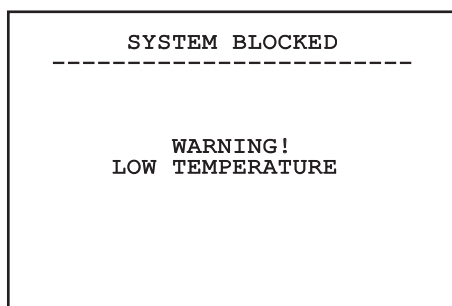

PROBLEMA Non compare l'immagine ripresa, ma una schermata del tipo:

```

                INFO
-----
Device ID: 00001
Type      : Rs485 only Rx
Baud Rate: 19200-8N1
Protocol  : PELCO-D
Net Board: Fw05.01 Hw00
Mpp Board: Fw05.01 Hw00
Config.   : 001
P.C.      : UPT1SMSA005C
S.N.      : 00000000000000
Upgrade   : NET BOARD
  
```

CAUSA Dip-switch di programmazione attivo.

SOLUZIONE Spegnerne il brandeggio. Abbassare la levetta del dip-switch di aggiornamento del firmware (8.14.2 Configurazione del DIP1, pagina 34). Accendere nuovamente l'unità.

PROBLEMA **Errore E1: PATROL CONFIGURATION.**

CAUSA I preset non sono stati memorizzati.

I preset non sono stati abilitati.

SOLUZIONE Salvare due o più preset (12.2 Salvataggio di un Preset, pagina 54). Aggiornare il menù di configurazione Patrol (10.1.8.6 Menù Patrol, pagina 48).

Abilitare i preset (10.1.8.4 Menù Preset (Modifica Preset), pagina 47).

PROBLEMA **Errore E2:AUTOPAN CONFIGURATION.**

CAUSA I due preset utilizzati come limiti non sono stati memorizzati.

I due preset utilizzati come limiti non sono stati abilitati.

SOLUZIONE Salvare i due preset (12.2 Salvataggio di un Preset, pagina 54). Aggiornare il menù di configurazione dell'autopan (10.1.8.7 Menù Autopan, pagina 48).

Abilitare i preset (10.1.8.4 Menù Preset (Modifica Preset), pagina 47).

PROBLEMA **Errore E3:WASHER DISABLED oppure errore E4:WASHER PRST DISABLED.**

CAUSA Impianto di lavaggio non abilitato.

SOLUZIONE Abilitare l'impianto di lavaggio (10.1.10.3 Menù Impianto di Lavaggio, pagina 51).

PROBLEMA **Errore PRESET XXX NOT ENABLED.**

CAUSA Richiamo di un preset non memorizzato.

Richiamo di un preset non abilitato.

SOLUZIONE Salvare il preset con l'apposito comando (12.2 Salvataggio di un Preset, pagina 54).

Abilitare il preset (10.1.8.4 Menù Preset (Modifica Preset), pagina 47).

17 Dati tecnici

17.1 Generale

Costruzione in pressofusione di alluminio e tecnopolimero

Verniciatura a polveri di epossipoliestere, colore RAL9002

Top mount (OTT)

Finecorsa elettronici

Assenza di gioco meccanico

Peso massimo consentito per telecamera e ottica: 7.6kg

Sensori ottici per feedback su posizionamento assoluto

Numero massimo di preset: 250 (VIDEOTEC MACRO)

Stringa di 15 caratteri per titolazione dell'area e dei preset

Configurabile da OSM

Fino a 255 unità indirizzabili tramite DIP-switch

17.2 Meccanica

Pressacavi: 3xM16

Rotazione orizzontale: continua

Rotazione verticale: da +45° fino a -20°

Velocità orizzontale (variabile): da 0.02°/s fino a 20°/s

Velocità verticale (variabile): da 0.02°/s fino a 20°/s

Dimensioni utili interne: Vedi disegni

Trasmissione per mezzo di cinghia dentata

Accuratezza del richiamo delle posizioni di preset: 0.02°

Peso unitario: 30kg

17.3 Finestre per custodia

Finestra in vetro

- Dimensioni: 112mmx95mm

Finestra in germanio

- Diametro: 85mm (esterno), 70mm (diametro utile)
- Spessore: 2mm
- Trattamento esterno antigraffio: Hard Carbon Coating (DLC)
- Trattamento interno antiriflesso

Range spettrale: da 7.5µm fino a 14µm

Trasmittanza media (da 7.5µm fino a 11.5µm): 94%

Trasmittanza media (da 11.5µm fino a 14µm): 90%

Trasmittanza della finestra in germanio

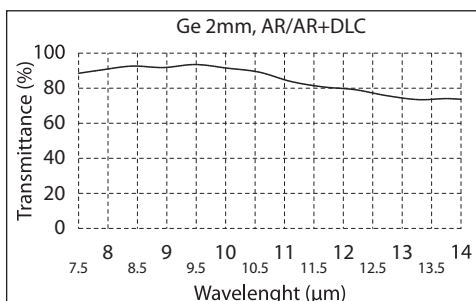

Fig. 125

17.4 Elettrico

Tensione di alimentazione/Corrente assorbita:

- 230Vac, 0.4A, 50/60Hz
- 24Vac, 4A (8A con illuminatori a LED), 50/60Hz
- 120Vac, 0.8A, 50/60Hz

Potenza assorbita:

- 100W
- 150-190W max con illuminatori a LED in 24Vac
- 24W, brandeggio fermo, riscaldamento spento

Alimentazione della telecamera: 12Vdc, 800mA

Sezione dei cavi d'ingresso:

- 0.75mm² (18AWG), 120Vac oppure 230Vac
- 1.5mm² (16AWG), 24Vac

Sezione dei cavi di segnale: da 0.14mm² (26AWG) fino a 0.5mm² (20AWG)

17.5 Video

Linea video: cavo coassiale (1Vpp, 75Ohm)

17.6 Comunicazioni

Interfaccia RS-232 per aggiornamento firmware

2 porte RS-485 per configurazione a catena

17.7 Protocolli

Configurazione tramite DIP-switch dei parametri dei protocolli di telemetria

Protocolli supportati:

- AMERICAN DYNAMICS
- PANASONIC
- PELCO D
- VIDEOTEC MACRO
- VISTA

17.8 Interfaccia I/O

Ingressi di allarme:

- 4 (versione standard)
- 2 (versione con illuminatori a LED)
- Tensione di controllo: Da 10Vdc fino a 35Vdc

Contatti puliti:

- 2 (versione standard)
- 1 (versione con illuminatori a LED)
- Tensione applicabile: 50Vdc max oppure 30Vac @1A

17.9 Ottiche

Alimentazione: Da 6Vdc a 15Vdc, 200mA max

Controllo: A inversione di polarità e a filo comune

17.10 Ambiente

Interno/Esterno

Temperatura di esercizio (con riscaldamento): Da -10°C fino a +60°C

17.11 Certificazioni

Sicurezza elettrica (CE): EN60950-1

Compatibilità elettromagnetica (CE): EN50130-4, EN55022 (Classe B), FCC Part 15 (Classe B)

Installazione all'esterno (CE): EN60950-22

Grado di protezione IP: EN60529 (IP66)

Resistenza alla nebbia salina: EN50130-5, EN60068-2-52

Certificazione EAC

18 Disegni tecnici

i Le dimensioni dei disegni sono espresse in millimetri.

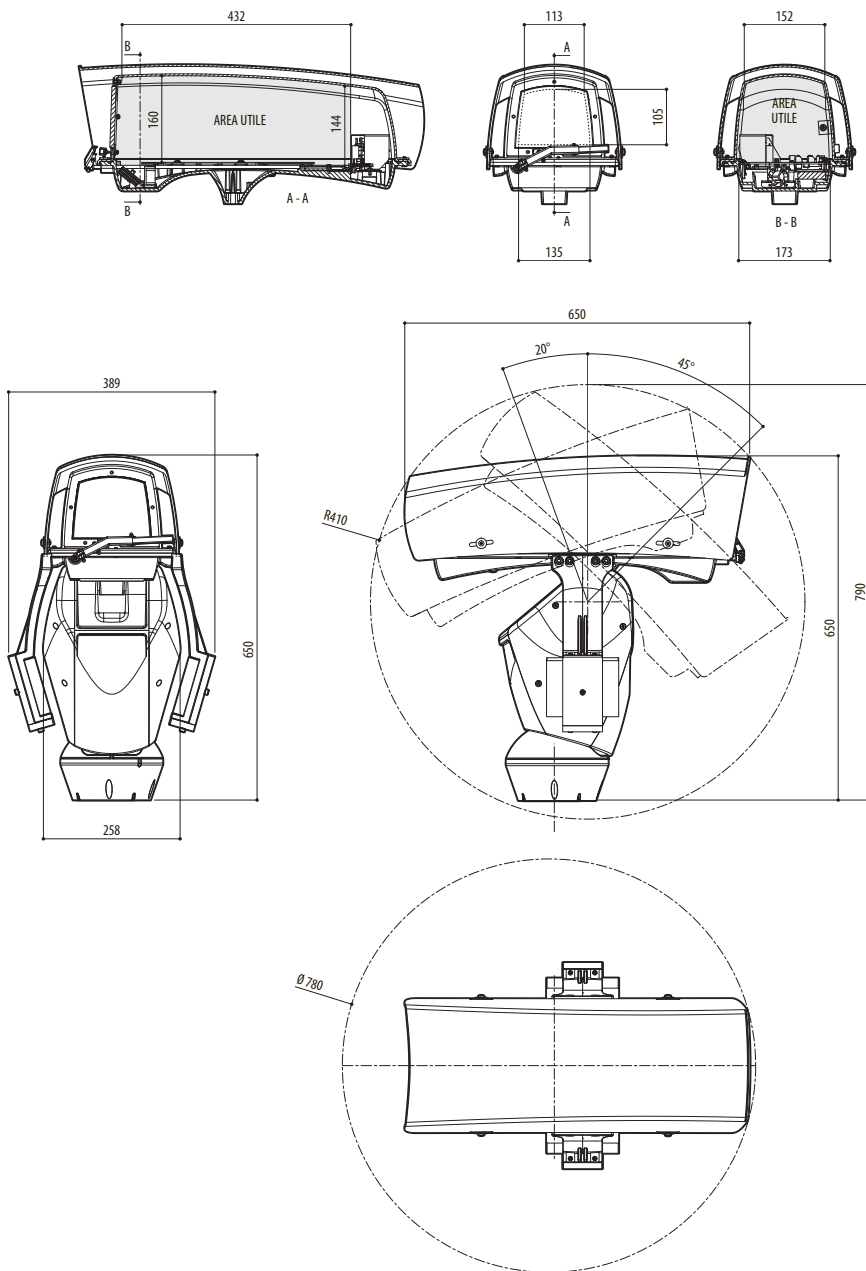

Fig. 126 ULISSE MAXI, versione standard.

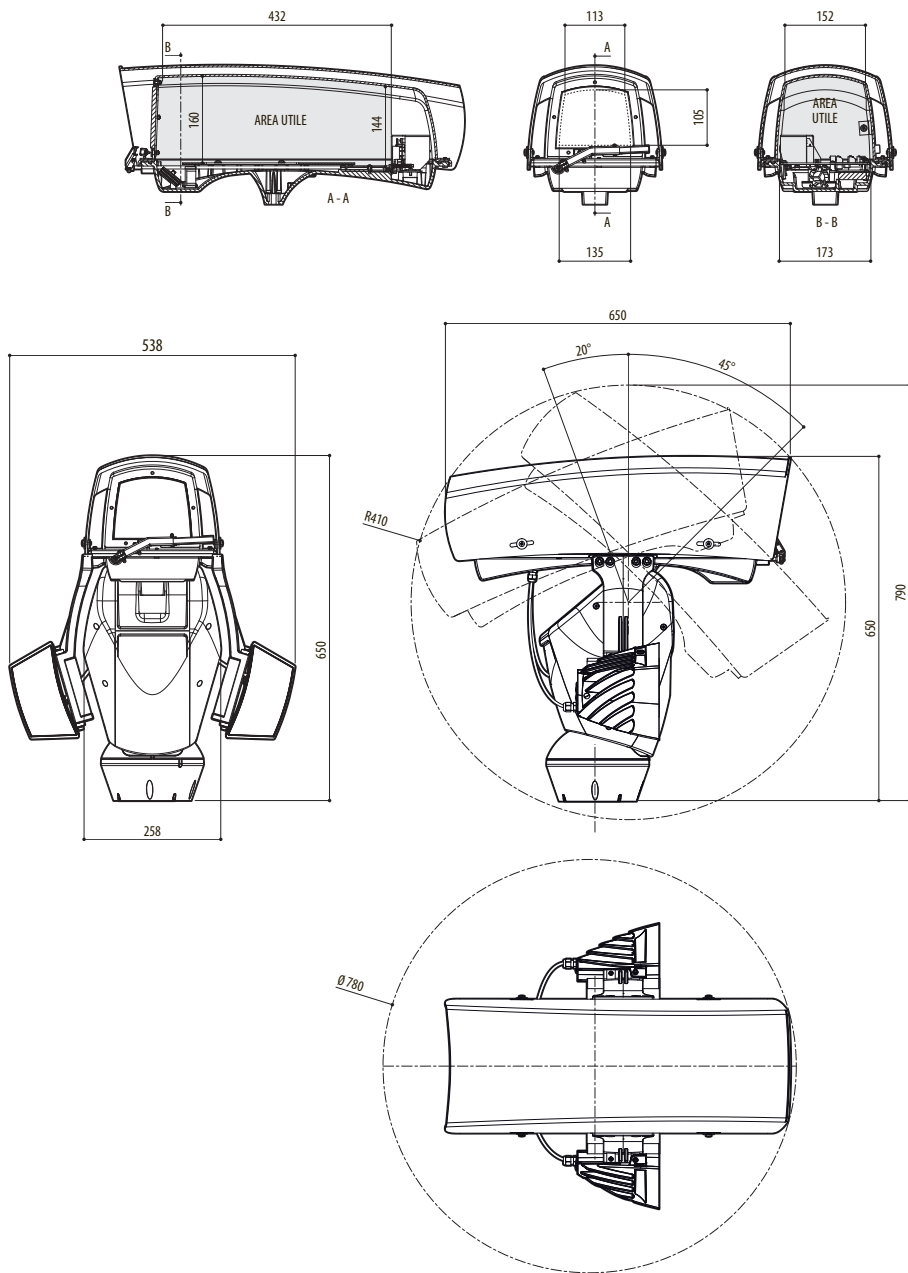

Fig. 127 ULISSE MAXI, versione con predisposizione per il montaggio di due illuminatori a LED.

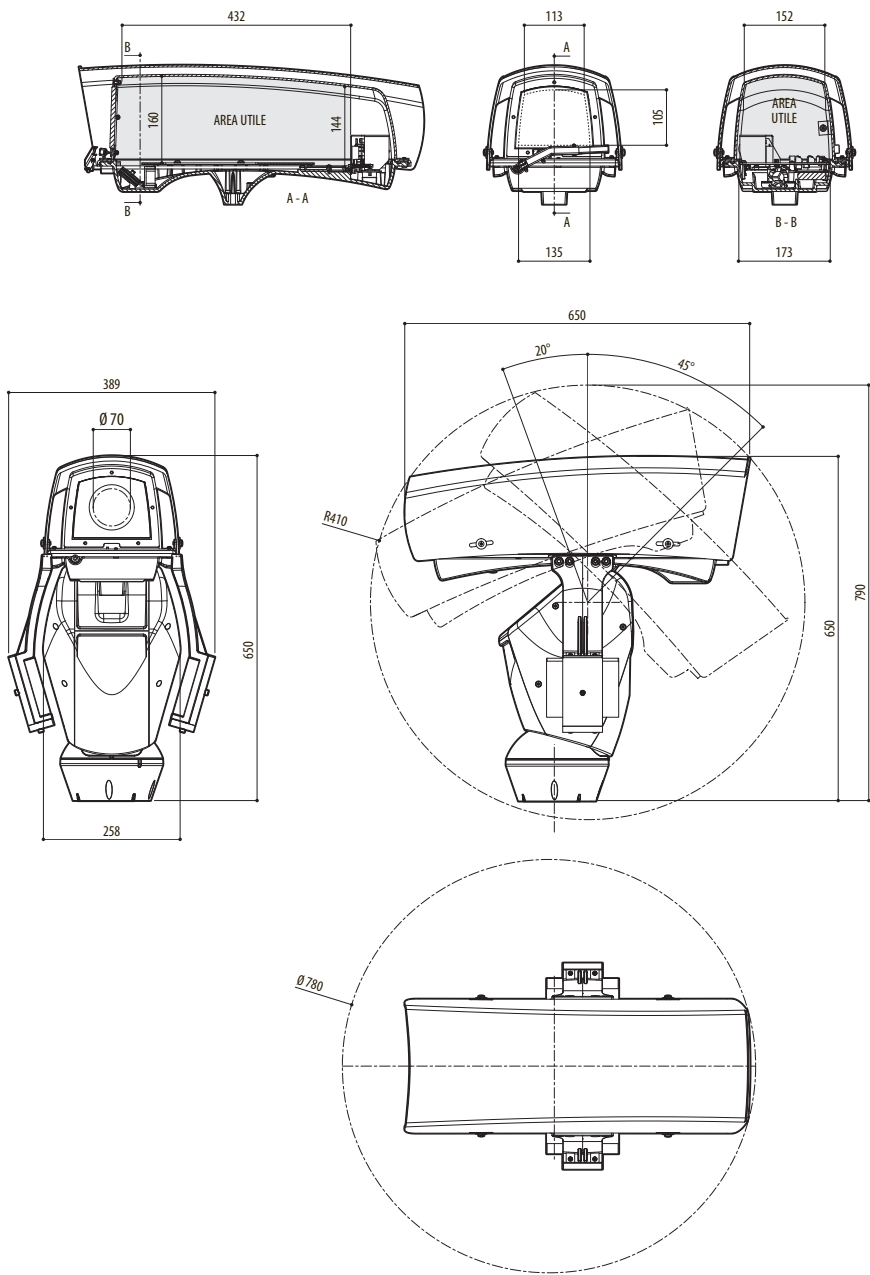

Fig. 128 ULISSE MAXI, versione per telecamere termiche.

A Appendice - Tabella degli indirizzi



La levetta dello switch verso l'alto rappresenta il valore 1 (ON). La levetta verso il basso rappresenta il valore 0 (OFF).

Di seguito sono riportate tutte le combinazioni possibili.

CONFIGURAZIONE DELL'INDIRIZZO (DIP 3)								
SW 8	SW 7	SW 6	SW 5	SW 4	SW 3	SW 2	SW 1	Indirizzo
OFF	OFF	OFF	OFF	OFF	OFF	OFF	OFF	Indirizzo non valido
OFF	OFF	OFF	OFF	OFF	OFF	OFF	ON	Indirizzo 1
OFF	OFF	OFF	OFF	OFF	OFF	ON	OFF	Indirizzo 2
OFF	OFF	OFF	OFF	OFF	OFF	ON	ON	Indirizzo 3
OFF	OFF	OFF	OFF	OFF	ON	OFF	OFF	Indirizzo 4
OFF	OFF	OFF	OFF	OFF	ON	OFF	ON	Indirizzo 5
OFF	OFF	OFF	OFF	OFF	ON	ON	OFF	Indirizzo 6
OFF	OFF	OFF	OFF	OFF	ON	ON	ON	Indirizzo 7
OFF	OFF	OFF	OFF	ON	OFF	OFF	OFF	Indirizzo 8
OFF	OFF	OFF	OFF	ON	OFF	OFF	ON	Indirizzo 9
OFF	OFF	OFF	OFF	ON	OFF	ON	OFF	Indirizzo 10
OFF	OFF	OFF	OFF	ON	OFF	ON	ON	Indirizzo 11
OFF	OFF	OFF	OFF	ON	ON	OFF	OFF	Indirizzo 12
OFF	OFF	OFF	OFF	ON	ON	OFF	ON	Indirizzo 13
OFF	OFF	OFF	OFF	ON	ON	ON	OFF	Indirizzo 14
OFF	OFF	OFF	OFF	ON	ON	ON	ON	Indirizzo 15
OFF	OFF	OFF	ON	OFF	OFF	OFF	OFF	Indirizzo 16
OFF	OFF	OFF	ON	OFF	OFF	OFF	ON	Indirizzo 17
OFF	OFF	OFF	ON	OFF	OFF	ON	OFF	Indirizzo 18
OFF	OFF	OFF	ON	OFF	OFF	ON	ON	Indirizzo 19
OFF	OFF	OFF	ON	OFF	ON	OFF	OFF	Indirizzo 20
OFF	OFF	OFF	ON	OFF	ON	OFF	ON	Indirizzo 21
OFF	OFF	OFF	ON	OFF	ON	ON	OFF	Indirizzo 22
OFF	OFF	OFF	ON	OFF	ON	ON	ON	Indirizzo 23
OFF	OFF	OFF	ON	ON	OFF	OFF	OFF	Indirizzo 24
OFF	OFF	OFF	ON	ON	OFF	OFF	ON	Indirizzo 25
OFF	OFF	OFF	ON	ON	OFF	ON	OFF	Indirizzo 26
OFF	OFF	OFF	ON	ON	OFF	ON	ON	Indirizzo 27
OFF	OFF	OFF	ON	ON	ON	OFF	OFF	Indirizzo 28
OFF	OFF	OFF	ON	ON	ON	OFF	ON	Indirizzo 29
OFF	OFF	OFF	ON	ON	ON	ON	OFF	Indirizzo 30
OFF	OFF	OFF	ON	ON	ON	ON	ON	Indirizzo 31
OFF	OFF	ON	OFF	OFF	OFF	OFF	OFF	Indirizzo 32
OFF	OFF	ON	OFF	OFF	OFF	OFF	ON	Indirizzo 33
OFF	OFF	ON	OFF	OFF	OFF	ON	OFF	Indirizzo 34
OFF	OFF	ON	OFF	OFF	OFF	ON	ON	Indirizzo 35
OFF	OFF	ON	OFF	OFF	ON	OFF	OFF	Indirizzo 36
OFF	OFF	ON	OFF	OFF	ON	OFF	ON	Indirizzo 37
OFF	OFF	ON	OFF	OFF	ON	ON	OFF	Indirizzo 38

CONFIGURAZIONE DELL'INDIRIZZO (DIP 3)								
SW 8	SW 7	SW 6	SW 5	SW 4	SW 3	SW 2	SW 1	Indirizzo
OFF	OFF	ON	OFF	OFF	ON	ON	ON	Indirizzo 39
OFF	OFF	ON	OFF	ON	OFF	OFF	OFF	Indirizzo 40
OFF	OFF	ON	OFF	ON	OFF	OFF	ON	Indirizzo 41
OFF	OFF	ON	OFF	ON	OFF	ON	OFF	Indirizzo 42
OFF	OFF	ON	OFF	ON	OFF	ON	ON	Indirizzo 43
OFF	OFF	ON	OFF	ON	ON	OFF	OFF	Indirizzo 44
OFF	OFF	ON	OFF	ON	ON	OFF	ON	Indirizzo 45
OFF	OFF	ON	OFF	ON	ON	ON	OFF	Indirizzo 46
OFF	OFF	ON	OFF	ON	ON	ON	ON	Indirizzo 47
OFF	OFF	ON	ON	OFF	OFF	OFF	OFF	Indirizzo 48
OFF	OFF	ON	ON	OFF	OFF	OFF	ON	Indirizzo 49
OFF	OFF	ON	ON	OFF	OFF	ON	OFF	Indirizzo 50
OFF	OFF	ON	ON	OFF	OFF	ON	ON	Indirizzo 51
OFF	OFF	ON	ON	OFF	ON	OFF	OFF	Indirizzo 52
OFF	OFF	ON	ON	OFF	ON	OFF	ON	Indirizzo 53
OFF	OFF	ON	ON	OFF	ON	ON	OFF	Indirizzo 54
OFF	OFF	ON	ON	OFF	ON	ON	ON	Indirizzo 55
OFF	OFF	ON	ON	ON	OFF	OFF	OFF	Indirizzo 56
OFF	OFF	ON	ON	ON	OFF	OFF	ON	Indirizzo 57
OFF	OFF	ON	ON	ON	OFF	ON	OFF	Indirizzo 58
OFF	OFF	ON	ON	ON	OFF	ON	ON	Indirizzo 59
OFF	OFF	ON	ON	ON	ON	OFF	OFF	Indirizzo 60
OFF	OFF	ON	ON	ON	ON	OFF	ON	Indirizzo 61
OFF	OFF	ON	ON	ON	ON	ON	OFF	Indirizzo 62
OFF	OFF	ON	ON	ON	ON	ON	ON	Indirizzo 63
OFF	ON	OFF	OFF	OFF	OFF	OFF	OFF	Indirizzo 64
OFF	ON	OFF	OFF	OFF	OFF	OFF	ON	Indirizzo 65
OFF	ON	OFF	OFF	OFF	OFF	ON	OFF	Indirizzo 66
OFF	ON	OFF	OFF	OFF	OFF	ON	ON	Indirizzo 67
OFF	ON	OFF	OFF	OFF	ON	OFF	OFF	Indirizzo 68
OFF	ON	OFF	OFF	OFF	ON	OFF	ON	Indirizzo 69
OFF	ON	OFF	OFF	OFF	ON	ON	OFF	Indirizzo 70
OFF	ON	OFF	OFF	OFF	ON	ON	ON	Indirizzo 71
OFF	ON	OFF	OFF	ON	OFF	OFF	OFF	Indirizzo 72
OFF	ON	OFF	OFF	ON	OFF	OFF	ON	Indirizzo 73
OFF	ON	OFF	OFF	ON	OFF	ON	OFF	Indirizzo 74
OFF	ON	OFF	OFF	ON	OFF	ON	ON	Indirizzo 75
OFF	ON	OFF	OFF	ON	ON	OFF	OFF	Indirizzo 76
OFF	ON	OFF	OFF	ON	ON	OFF	ON	Indirizzo 77
OFF	ON	OFF	OFF	ON	ON	ON	OFF	Indirizzo 78
OFF	ON	OFF	OFF	ON	ON	ON	ON	Indirizzo 79
OFF	ON	OFF	ON	OFF	OFF	OFF	OFF	Indirizzo 80
OFF	ON	OFF	ON	OFF	OFF	OFF	ON	Indirizzo 81
OFF	ON	OFF	ON	OFF	OFF	ON	OFF	Indirizzo 82

CONFIGURAZIONE DELL'INDIRIZZO (DIP 3)								
SW 8	SW 7	SW 6	SW 5	SW 4	SW 3	SW 2	SW 1	Indirizzo
OFF	ON	OFF	ON	OFF	OFF	ON	ON	Indirizzo 83
OFF	ON	OFF	ON	OFF	ON	OFF	OFF	Indirizzo 84
OFF	ON	OFF	ON	OFF	ON	OFF	ON	Indirizzo 85
OFF	ON	OFF	ON	OFF	ON	ON	OFF	Indirizzo 86
OFF	ON	OFF	ON	OFF	ON	ON	ON	Indirizzo 87
OFF	ON	OFF	ON	ON	OFF	OFF	OFF	Indirizzo 88
OFF	ON	OFF	ON	ON	OFF	ON	OFF	Indirizzo 89
OFF	ON	OFF	ON	ON	OFF	ON	OFF	Indirizzo 90
OFF	ON	OFF	ON	ON	OFF	ON	ON	Indirizzo 91
OFF	ON	OFF	ON	ON	ON	OFF	OFF	Indirizzo 92
OFF	ON	OFF	ON	ON	ON	OFF	ON	Indirizzo 93
OFF	ON	OFF	ON	ON	ON	ON	OFF	Indirizzo 94
OFF	ON	OFF	ON	ON	ON	ON	ON	Indirizzo 95
OFF	ON	ON	OFF	OFF	OFF	OFF	OFF	Indirizzo 96
OFF	ON	ON	OFF	OFF	OFF	OFF	ON	Indirizzo 97
OFF	ON	ON	OFF	OFF	OFF	ON	OFF	Indirizzo 98
OFF	ON	ON	OFF	OFF	OFF	ON	ON	Indirizzo 99
OFF	ON	ON	OFF	OFF	ON	OFF	OFF	Indirizzo 100
OFF	ON	ON	OFF	OFF	ON	OFF	ON	Indirizzo 101
OFF	ON	ON	OFF	OFF	ON	ON	OFF	Indirizzo 102
OFF	ON	ON	OFF	OFF	ON	ON	ON	Indirizzo 103
OFF	ON	ON	OFF	ON	OFF	OFF	OFF	Indirizzo 104
OFF	ON	ON	OFF	ON	OFF	OFF	ON	Indirizzo 105
OFF	ON	ON	OFF	ON	OFF	ON	OFF	Indirizzo 106
OFF	ON	ON	OFF	ON	OFF	ON	ON	Indirizzo 107
OFF	ON	ON	OFF	ON	ON	OFF	OFF	Indirizzo 108
OFF	ON	ON	OFF	ON	ON	OFF	ON	Indirizzo 109
OFF	ON	ON	OFF	ON	ON	ON	OFF	Indirizzo 110
OFF	ON	ON	OFF	ON	ON	ON	ON	Indirizzo 111
OFF	ON	ON	ON	OFF	OFF	OFF	OFF	Indirizzo 112
OFF	ON	ON	ON	OFF	OFF	OFF	ON	Indirizzo 113
OFF	ON	ON	ON	OFF	OFF	ON	OFF	Indirizzo 114
OFF	ON	ON	ON	OFF	OFF	ON	ON	Indirizzo 115
OFF	ON	ON	ON	OFF	ON	OFF	OFF	Indirizzo 116
OFF	ON	ON	ON	OFF	ON	OFF	ON	Indirizzo 117
OFF	ON	ON	ON	OFF	ON	ON	OFF	Indirizzo 118
OFF	ON	ON	ON	OFF	ON	ON	ON	Indirizzo 119
OFF	ON	ON	ON	ON	OFF	OFF	OFF	Indirizzo 120
OFF	ON	ON	ON	ON	OFF	OFF	ON	Indirizzo 121
OFF	ON	ON	ON	ON	OFF	ON	OFF	Indirizzo 122
OFF	ON	ON	ON	ON	OFF	ON	ON	Indirizzo 123
OFF	ON	ON	ON	ON	ON	OFF	OFF	Indirizzo 124
OFF	ON	ON	ON	ON	ON	OFF	ON	Indirizzo 125
OFF	ON	ON	ON	ON	ON	ON	OFF	Indirizzo 126

CONFIGURAZIONE DELL'INDIRIZZO (DIP 3)								
SW 8	SW 7	SW 6	SW 5	SW 4	SW 3	SW 2	SW 1	Indirizzo
OFF	ON	ON	ON	ON	ON	ON	ON	Indirizzo 127
ON	OFF	OFF	OFF	OFF	OFF	OFF	OFF	Indirizzo 128
ON	OFF	OFF	OFF	OFF	OFF	OFF	ON	Indirizzo 129
ON	OFF	OFF	OFF	OFF	OFF	ON	OFF	Indirizzo 130
ON	OFF	OFF	OFF	OFF	OFF	ON	ON	Indirizzo 131
ON	OFF	OFF	OFF	OFF	ON	OFF	OFF	Indirizzo 132
ON	OFF	OFF	OFF	OFF	ON	OFF	ON	Indirizzo 133
ON	OFF	OFF	OFF	OFF	ON	ON	OFF	Indirizzo 134
ON	OFF	OFF	OFF	OFF	ON	ON	ON	Indirizzo 135
ON	OFF	OFF	OFF	ON	OFF	OFF	OFF	Indirizzo 136
ON	OFF	OFF	OFF	ON	OFF	OFF	ON	Indirizzo 137
ON	OFF	OFF	OFF	ON	OFF	ON	OFF	Indirizzo 138
ON	OFF	OFF	OFF	ON	OFF	ON	ON	Indirizzo 139
ON	OFF	OFF	OFF	ON	ON	OFF	OFF	Indirizzo 140
ON	OFF	OFF	OFF	ON	ON	OFF	ON	Indirizzo 141
ON	OFF	OFF	OFF	ON	ON	ON	OFF	Indirizzo 142
ON	OFF	OFF	OFF	ON	ON	ON	ON	Indirizzo 143
ON	OFF	OFF	ON	OFF	OFF	OFF	OFF	Indirizzo 144
ON	OFF	OFF	ON	OFF	OFF	OFF	ON	Indirizzo 145
ON	OFF	OFF	ON	OFF	OFF	ON	OFF	Indirizzo 146
ON	OFF	OFF	ON	OFF	OFF	ON	ON	Indirizzo 147
ON	OFF	OFF	ON	OFF	ON	OFF	OFF	Indirizzo 148
ON	OFF	OFF	ON	OFF	ON	OFF	ON	Indirizzo 149
ON	OFF	OFF	ON	OFF	ON	ON	OFF	Indirizzo 150
ON	OFF	OFF	ON	OFF	ON	ON	ON	Indirizzo 151
ON	OFF	OFF	ON	ON	OFF	OFF	OFF	Indirizzo 152
ON	OFF	OFF	ON	ON	OFF	OFF	ON	Indirizzo 153
ON	OFF	OFF	ON	ON	OFF	ON	OFF	Indirizzo 154
ON	OFF	OFF	ON	ON	OFF	ON	ON	Indirizzo 155
ON	OFF	OFF	ON	ON	ON	OFF	OFF	Indirizzo 156
ON	OFF	OFF	ON	ON	ON	OFF	ON	Indirizzo 157
ON	OFF	OFF	ON	ON	ON	ON	OFF	Indirizzo 158
ON	OFF	OFF	ON	ON	ON	ON	ON	Indirizzo 159
ON	OFF	ON	OFF	OFF	OFF	OFF	OFF	Indirizzo 160
ON	OFF	ON	OFF	OFF	OFF	OFF	ON	Indirizzo 161
ON	OFF	ON	OFF	OFF	OFF	ON	OFF	Indirizzo 162
ON	OFF	ON	OFF	OFF	OFF	ON	ON	Indirizzo 163
ON	OFF	ON	OFF	OFF	ON	OFF	OFF	Indirizzo 164
ON	OFF	ON	OFF	OFF	ON	OFF	ON	Indirizzo 165
ON	OFF	ON	OFF	OFF	ON	ON	OFF	Indirizzo 166
ON	OFF	ON	OFF	OFF	ON	ON	ON	Indirizzo 167
ON	OFF	ON	OFF	ON	OFF	OFF	OFF	Indirizzo 168
ON	OFF	ON	OFF	ON	OFF	OFF	ON	Indirizzo 169
ON	OFF	ON	OFF	ON	OFF	ON	OFF	Indirizzo 170

CONFIGURAZIONE DELL'INDIRIZZO (DIP 3)								
SW 8	SW 7	SW 6	SW 5	SW 4	SW 3	SW 2	SW 1	Indirizzo
ON	OFF	ON	OFF	ON	OFF	ON	ON	Indirizzo 171
ON	OFF	ON	OFF	ON	ON	OFF	OFF	Indirizzo 172
ON	OFF	ON	OFF	ON	ON	OFF	ON	Indirizzo 173
ON	OFF	ON	OFF	ON	ON	ON	OFF	Indirizzo 174
ON	OFF	ON	OFF	ON	ON	ON	ON	Indirizzo 175
ON	OFF	ON	ON	OFF	OFF	OFF	OFF	Indirizzo 176
ON	OFF	ON	ON	OFF	OFF	OFF	ON	Indirizzo 177
ON	OFF	ON	ON	OFF	OFF	ON	OFF	Indirizzo 178
ON	OFF	ON	ON	OFF	OFF	ON	ON	Indirizzo 179
ON	OFF	ON	ON	OFF	ON	OFF	OFF	Indirizzo 180
ON	OFF	ON	ON	OFF	ON	OFF	ON	Indirizzo 181
ON	OFF	ON	ON	OFF	ON	ON	OFF	Indirizzo 182
ON	OFF	ON	ON	OFF	ON	ON	ON	Indirizzo 183
ON	OFF	ON	ON	ON	OFF	OFF	OFF	Indirizzo 184
ON	OFF	ON	ON	ON	OFF	OFF	ON	Indirizzo 185
ON	OFF	ON	ON	ON	OFF	ON	OFF	Indirizzo 186
ON	OFF	ON	ON	ON	OFF	ON	ON	Indirizzo 187
ON	OFF	ON	ON	ON	ON	OFF	OFF	Indirizzo 188
ON	OFF	ON	ON	ON	ON	OFF	ON	Indirizzo 189
ON	OFF	ON	ON	ON	ON	ON	OFF	Indirizzo 190
ON	OFF	ON	ON	ON	ON	ON	ON	Indirizzo 191
ON	ON	OFF	OFF	OFF	OFF	OFF	OFF	Indirizzo 192
ON	ON	OFF	OFF	OFF	OFF	OFF	ON	Indirizzo 193
ON	ON	OFF	OFF	OFF	OFF	ON	OFF	Indirizzo 194
ON	ON	OFF	OFF	OFF	OFF	ON	ON	Indirizzo 195
ON	ON	OFF	OFF	OFF	ON	OFF	OFF	Indirizzo 196
ON	ON	OFF	OFF	OFF	ON	OFF	ON	Indirizzo 197
ON	ON	OFF	OFF	OFF	ON	ON	OFF	Indirizzo 198
ON	ON	OFF	OFF	OFF	ON	ON	ON	Indirizzo 199
ON	ON	OFF	OFF	ON	OFF	OFF	OFF	Indirizzo 200
ON	ON	OFF	OFF	ON	OFF	OFF	ON	Indirizzo 201
ON	ON	OFF	OFF	ON	OFF	ON	OFF	Indirizzo 202
ON	ON	OFF	OFF	ON	OFF	ON	ON	Indirizzo 203
ON	ON	OFF	OFF	ON	ON	OFF	OFF	Indirizzo 204
ON	ON	OFF	OFF	ON	ON	OFF	ON	Indirizzo 205
ON	ON	OFF	OFF	ON	ON	ON	OFF	Indirizzo 206
ON	ON	OFF	OFF	ON	ON	ON	ON	Indirizzo 207
ON	ON	OFF	ON	OFF	OFF	OFF	OFF	Indirizzo 208
ON	ON	OFF	ON	OFF	OFF	OFF	ON	Indirizzo 209
ON	ON	OFF	ON	OFF	OFF	ON	OFF	Indirizzo 210
ON	ON	OFF	ON	OFF	OFF	ON	ON	Indirizzo 211
ON	ON	OFF	ON	OFF	ON	OFF	OFF	Indirizzo 212
ON	ON	OFF	ON	OFF	ON	OFF	ON	Indirizzo 213
ON	ON	OFF	ON	OFF	ON	ON	OFF	Indirizzo 214

CONFIGURAZIONE DELL'INDIRIZZO (DIP 3)								
SW 8	SW 7	SW 6	SW 5	SW 4	SW 3	SW 2	SW 1	Indirizzo
ON	ON	OFF	ON	OFF	ON	ON	ON	Indirizzo 215
ON	ON	OFF	ON	ON	OFF	OFF	OFF	Indirizzo 216
ON	ON	OFF	ON	ON	OFF	OFF	ON	Indirizzo 217
ON	ON	OFF	ON	ON	OFF	ON	OFF	Indirizzo 218
ON	ON	OFF	ON	ON	OFF	ON	ON	Indirizzo 219
ON	ON	OFF	ON	ON	ON	OFF	OFF	Indirizzo 220
ON	ON	OFF	ON	ON	ON	OFF	ON	Indirizzo 221
ON	ON	OFF	ON	ON	ON	ON	OFF	Indirizzo 222
ON	ON	OFF	ON	ON	ON	ON	ON	Indirizzo 223
ON	ON	ON	OFF	OFF	OFF	OFF	OFF	Indirizzo 224
ON	ON	ON	OFF	OFF	OFF	OFF	ON	Indirizzo 225
ON	ON	ON	OFF	OFF	OFF	ON	OFF	Indirizzo 226
ON	ON	ON	OFF	OFF	OFF	ON	ON	Indirizzo 227
ON	ON	ON	OFF	OFF	ON	OFF	OFF	Indirizzo 228
ON	ON	ON	OFF	OFF	ON	OFF	ON	Indirizzo 229
ON	ON	ON	OFF	OFF	ON	ON	OFF	Indirizzo 230
ON	ON	ON	OFF	OFF	ON	ON	ON	Indirizzo 231
ON	ON	ON	OFF	ON	OFF	OFF	OFF	Indirizzo 232
ON	ON	ON	OFF	ON	OFF	OFF	ON	Indirizzo 233
ON	ON	ON	OFF	ON	OFF	ON	OFF	Indirizzo 234
ON	ON	ON	OFF	ON	OFF	ON	ON	Indirizzo 235
ON	ON	ON	OFF	ON	ON	OFF	OFF	Indirizzo 236
ON	ON	ON	OFF	ON	ON	OFF	ON	Indirizzo 237
ON	ON	ON	OFF	ON	ON	ON	OFF	Indirizzo 238
ON	ON	ON	OFF	ON	ON	ON	ON	Indirizzo 239
ON	ON	ON	ON	OFF	OFF	OFF	OFF	Indirizzo 240
ON	ON	ON	ON	OFF	OFF	OFF	ON	Indirizzo 241
ON	ON	ON	ON	OFF	OFF	ON	OFF	Indirizzo 242
ON	ON	ON	ON	OFF	OFF	ON	ON	Indirizzo 243
ON	ON	ON	ON	OFF	ON	OFF	OFF	Indirizzo 244
ON	ON	ON	ON	OFF	ON	OFF	ON	Indirizzo 245
ON	ON	ON	ON	OFF	ON	ON	OFF	Indirizzo 246
ON	ON	ON	ON	OFF	ON	ON	ON	Indirizzo 247
ON	ON	ON	ON	ON	OFF	OFF	OFF	Indirizzo 248
ON	ON	ON	ON	ON	OFF	OFF	ON	Indirizzo 249
ON	ON	ON	ON	ON	OFF	ON	OFF	Indirizzo 250
ON	ON	ON	ON	ON	OFF	ON	ON	Indirizzo 251
ON	ON	ON	ON	ON	ON	OFF	OFF	Indirizzo 252
ON	ON	ON	ON	ON	ON	OFF	ON	Indirizzo 253
ON	ON	ON	ON	ON	ON	ON	OFF	Indirizzo 254
ON	ON	ON	ON	ON	ON	ON	ON	Indirizzo 255

Tab. 21

Headquarters Italy Videotec S.p.A.

Via Friuli, 6 - I-36015 Schio (VI) - Italy

Tel. +39 0445 697411 - Fax +39 0445 697414

Email: info@videotec.com

Asia Pacific Videotec (HK) Ltd

Flat 8, 19/F. On Dak Industrial Building, No. 2-6 Wah Sing Street

Kwai Chung, New Territories - Hong Kong

Tel. +852 2333 0601 - Fax +852 2311 0026

Email: info.hk@videotec.com

France Videotec France SARL

Immeuble Le Montreal, 19bis Avenue du Québec, ZA de Courtaboeuf

91140 Villebon sur Yvette - France

Tel. +33 1 60491816 - Fax +33 1 69284736

Email: info.fr@videotec.com

Americas Videotec Security, Inc.

Gateway Industrial Park, 35 Gateway Drive, Suite 100

Plattsburgh, NY 12901 - U.S.A.

Tel. +1 518 825 0020 - Fax +1 518 825 0022

Email: info.usa@videotec.com - www.videotec.com



www.videotec.com

MNVCUPTMAXB_1511_IT



ULISSE MAXI

Unité PTZ pour la surveillance dynamique de vastes zones extérieures

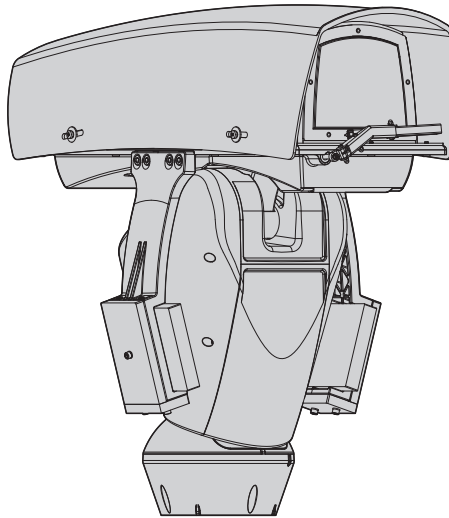

Sommaire

1 À propos de ce mode d'emploi	7
1.1 Conventions typographiques	7
2 Notes sur le copyright et informations sur les marques de commerce	7
3 Normes de sécurité.....	7
4 Identification.....	10
4.1 Description et désignation du produit	10
4.2 Marquage du produit.....	10
4.2.1 Contrôle du marquage	10
5 Versions	11
5.1 Projecteurs à LED	11
5.2 Fenêtre au germanium	11
6 Préparation du produit en vue de l'utilisation.....	12
6.1 Précautions de sécurité avant l'utilisation	12
6.2 Déballage.....	12
6.3 Contenu.....	12
6.4 Élimination sans danger des matériaux d'emballage.....	12
6.5 Opérations à effectuer avant l'installation.....	13
6.5.1 Fixation du support	13
6.5.2 Passage des câbles.....	13
7 Assemblage.....	14
7.1 Fixation du double toit	14
7.2 Ouverture du caisson	14
7.3 Montage caméras, systèmes optiques motorisés.....	14
7.3.1 Caractéristiques des caméras.....	14
7.3.2 Fixation de l'optique et de la caméra à la glissière interne.....	15
7.3.3 Positionnement de l'entretoise H-20 sur la glissière interne	16
7.3.4 Glissière interne.....	16
7.4 Description de la carte du caisson.....	17
7.4.1 Branchement de la caméra et de l'optique motorisée.....	17
7.4.2 Réglage de la tension d'alimentation des moteurs des optiques.....	18
8 Installation	19
8.1 Connexion des câbles à la base	19
8.2 Fixage de la base au support.....	20
8.3 Description de la carte de connexion	21
8.4 Connexion de la ligne d'alimentation	22
8.4.1 Connexion de la ligne d'alimentation en 24Vac.....	23
8.4.2 Raccordement de la ligne d'alimentation en 120Vac et 230Vac	23
8.5 Connexion des câbles de signalisation	24
8.5.1 Connexion du câble vidéo	24
8.5.2 Connexion des lignes de télémétrie.....	25
8.5.3 Branchement des entrées d'alarme, de l'interrupteur crépusculaire et des relais	26

8.6	Fixation du corps supérieur	27
8.7	Montage du contrepoids	27
8.8	Montage des projecteurs à LED	28
8.8.1	Retrait des contrepoids	28
8.8.2	Montage du projecteur sur l'étrier	28
8.9	Branchement des projecteur à LED.....	29
8.10	Connexion pour la synchronisation des caméras avec les projecteurs à LED.....	30
8.11	Sachet déshydratant	30
8.12	Réglage et modalité d'activation des projecteurs à LED	30
8.12.1	Description du projecteur à LED	30
8.12.2	Activation des projecteurs à LED à l'aide d'un interrupteur crépusculaire externe.....	31
8.12.3	Activation des projecteurs à LED à l'aide du détecteur crépusculaire intégré	31
8.12.4	Réglage du seuil d'allumage des projecteurs à LED.....	32
8.12.5	Réglage de la puissance des projecteurs à LED	32
8.13	Fixation du balai essuie-glace.....	33
8.14	Configuration du matériel.....	34
8.14.1	Ouverture du volet de configuration.....	34
8.14.2	Configuration du DIP1.....	34
8.14.3	Configuration du DIP2.....	34
8.14.4	Configuration du DIP3.....	35
8.14.4.1	Configuration de l'adresse	35
8.14.4.2	Configuration des lignes de communications sérieelles	35
8.14.5	Configuration du DIP4.....	35
8.14.6	Exemple d'installation.....	36
8.14.6.1	Ligne RS-485 RX	36
8.14.6.2	Ligne RS-422 (RS-485-1 RX e RS-485-2 TX).....	36
8.14.6.3	Ligne RS-485-1 réception, ligne RS-485-2 répétition	36
8.14.6.4	Ligne RS-485 TX/RX bidirectionnelle	36
9	Allumage	37
9.1	Premier allumage.....	37
9.2	Liste des contrôles	37
10	Configuration.....	38
10.1	Interface OSM (On Screen Menu).....	38
10.1.1	Utilisation de l'OSM	38
10.1.1.1	Utilisation du joystick.....	38
10.1.1.2	Comment se déplacer dans le menu	39
10.1.1.3	Comment modifier les paramètres.....	39
10.1.1.4	Comment modifier les champs numériques.....	40
10.1.1.5	Comment modifier les textes.....	40
10.1.2	Configuration par OSM	42
10.1.3	Menu Principal	42
10.1.4	Menu Choix Langue	42
10.1.5	Menu Paramètres ZFI.....	42
10.1.5.1	Menu Titrage Des Zones	43
10.1.5.2	Menu Masquage des Zones	44
10.1.6	Menu Communication Sérieelle Caisson	45
10.1.7	Menu Polarité	45
10.1.8	Menu Mouvement.....	46
10.1.8.1	Menu Contrôle Manuel	46

10.1.8.2 Menu Contrôle Manuel (Limites)	47
10.1.8.3 Menu Preset	47
10.1.8.4 Menu Preset (Modifier Preset)	47
10.1.8.5 Menu Preset (Utilités Preset)	48
10.1.8.6 Menu Patrol	48
10.1.8.7 Menu Autopan	48
10.1.8.8 Menu Rappel Mouvements	49
10.1.9 Menu Affichages.....	49
10.1.10 Menu I/O Numériques-Options.....	49
10.1.10.1 Menu Alarmes.....	50
10.1.10.2 Menu des Communications.....	50
10.1.10.3 Menu Système de lavage.....	51
10.1.11 Menu Par Défaut	51
10.1.12 Menu Infos	51
11 Accessoires.....	52
11.1 Système de lavage	52
11.1.1 Branchement du système de lavage.....	52
11.2 Support fixation murale.....	53
11.3 Support fixation sol.....	53
11.4 Alimentateur avec contrôle des projecteurs.....	53
12 Instructions de fonctionnement courant	54
12.1 Affichage de l'état de la tourelle	54
12.2 Enregistrement d'un Preset	54
12.3 Rappel d'une position de Preset (Scan).....	54
12.4 Rappel de la position de Home.....	54
12.5 Activation du Patrol.....	54
12.6 Activation de l'Autopan.....	55
12.7 Validation de l'essuie-glace (Wiper).....	55
12.8 Activation du système de lavage (Washer).....	55
12.9 Activation du projecteur à LED	55
12.10 Reboot du dispositif.....	55
12.11 Commandes spéciales	56
12.12 Configuration spéciales.....	57
13 Entretien.....	58
13.1 Remplacement des fusibles.....	58
14 Nettoyage.....	58
14.1 Entretien de la vitre et des parties en plastique.....	58
14.2 Nettoyage de la fenêtre au germanium.....	58
15 Élimination des déchets.....	58
16 Dépannage.....	59
17 Données techniques.....	61
17.1 Généralités.....	61
17.2 Mécanique	61
17.3 Fenêtres pour caisson	61
17.4 Électrique	61

17.5 Vidéo	62
17.6 Communications	62
17.7 Protocoles	62
17.8 Interface I/O	62
17.9 Optiques	62
17.10 Environnement	62
17.11 Certifications	62
18 Dessins techniques.....	63
A Annexe - Tableau des adresses.....	66

1 À propos de ce mode d'emploi

Avant d'installer et d'utiliser cette unité, lire attentivement toute la documentation fournie. Garder le manuel à portée de main pour des consultations successives.

1.1 Conventions typographiques



DANGER!

Risque élevé.

Risque de choc électrique. Sauf indication contraire, sectionner l'alimentation avant de procéder à toute opération.



DANGER!

Surface à température élevée.

Évitez le contact. La température des surfaces est élevée et leur contact peut provoquer des blessures corporelles.



DANGER!

Danger mécanique.

Risque d'écrasement ou de cisaillement.



ATTENTION!

Risque moyen.

Opération extrêmement importante en vue d'un fonctionnement correct du système; lire avec attention les opérations indiquées et s'y conformer rigoureusement.



REMARQUE

Description des caractéristiques du système.

Il est conseillé de procéder à une lecture attentive pour une meilleure compréhension des phases suivantes.

2 Notes sur le copyright et informations sur les marques de commerce

Les noms de produit ou de sociétés cités sont des marques de commerce ou des marques de commerce enregistrées.

3 Normes de sécurité



ATTENTION! Le circuit électrique auquel l'unité est reliée doit être équipé d'un interrupteur de protection bipolaire automatique de 20A max. Cet interrupteur doit être de type Listed. La distance minimale entre les de l'interrupteur de protection contacts doit être de 3mm. L'interrupteur doit être équipé de protection contre le courant de défaut vers la terre (différentiel) et le surintensité (magnétothermique).



ATTENTION! Parties mobiles dangereux. Ne pas approcher les doigts ou d'autres parties du corps.



ATTENTION! L'installation et l'entretien du dispositif doivent être effectués exclusivement par un personnel technique qualifié.



ATTENTION! Pour assurer la protection contre le risque d'incendie, remplacer les fusibles avec le même type et valeur. Les fusibles doivent être remplacés seulement par un personnel qualifié.



ATTENTION! L'installation est du type TNV-1. Ne pas la connecter à des circuits SELV.



ATTENTION! Pour réduire les risques d'incendie, utiliser uniquement des câbles certifiés UL Listed ou CSA de sections égales ou supérieures à 0.14mm² (26AWG).

- Le fabricant décline toute responsabilité pour les dommages éventuels dus à une utilisation non appropriée des appareils mentionnés dans ce manuel. On réserve en outre le droit d'en modifier le contenu sans préavis. La documentation contenue dans ce manuel a été rassemblée et vérifiée avec le plus grand soin. Le fabricant, cependant, ne peut assumer aucune responsabilité dérivant de l'emploi de celle là. La même chose vaut pour chaque personne ou société impliquées dans la création et la production de ce manuel.

- Sectionner l'alimentation avant de procéder à toute opération.
- Ne pas utiliser de câbles usés ou endommagés.
- Ne procéder sous aucun prétexte à des modifications ou des connexions non prévues dans ce manuel. L'utilisation d'appareils non adéquats peut comporter des dangers graves pour la sécurité du personnel et de l'installation.
- Utiliser uniquement des pièces de rechange d'origine. Les pièces non d'origine peuvent être source d'incendies, de choc électrique ou autres.
- Avant de procéder à l'installation, contrôler que le matériel fourni correspond à la commande et examiner les étiquettes de marquage (4.2 Marquage du produit, page 10).
- La catégorie d'installation (ou catégorie de surtension) spécifie les niveaux de la tension de secteur correspondant à l'appareil. La catégorie dépend du lieu d'installation et du dispositif de protection contre les surtensions installé. En cas d'environnement industriel directement connecté aux circuits de dérivation du système d'alimentation, l'équipement est classé dans la catégorie d'installation III. Dans ce cas, un déclassement à la catégorie II est nécessaire. Peut être obtenu au moyen d'un transformateur d'isolement avec blindage électrostatique entre le primaire et le secondaire ou en utilisant des dispositifs de protection contre les surtensions (SPD), UL listed, entre la phase et le neutre et entre le neutre et la terre. Les dispositifs SPD UL cités doivent être prévus pour limiter les surtensions transitoires en mode répétitif et pour les conditions nominales de fonctionnement suivantes: Type 2 (dispositifs SPD reliés en permanence au côté charge du côté du dispositif de protection contre les surintensités) ; courant nominal de décharge (In) 20kA min. Exemples d'utilisation possible : FERRAZ SHAWMUT, ST23401PG-CN, ST240SPG-CN spécifiés pour 120Vac/240Vca, (In=20kA). La distance maximale entre installation et réduction est de 5m.
- Cet appareil est conçu pour être fixé et relié de manière permanente sur un bâtiment ou une structure adéquate. L'appareil doit être fixé et relié de manière permanente avant d'effectuer toute opération.
- L'installation électrique doit être équipée d'un sectionneur de réseau facile à reconnaître et à utiliser en cas de nécessité.
- La borne de terre disponible dans le produit doit être connecté en permanence à la terre.
- Raccorder le système à une source d'alimentation conforme à celle figurant sur l'étiquette de marquage du produit. Avant de procéder à l'installation, vérifier que la ligne électrique est sectionnée. La tension d'alimentation doit être comprise dans les limites ($\pm 10\%$).
- Alimenter le dispositif avec une source isolée de type SELV, 24Vac, 8A dérivée d'un transformateur à double isolation UL Listed, opportunément protégé à la sortie.
- Les parties mobiles du système représentant un risque potentiel d'accident, le système doit être installé de façon à en empêcher l'accès aux personnes non autorisées.
- Appliquer l'étiquette Parties mobiles dangereuses près de l'unité. (Fig. 4, page 12).
- Ne pas utiliser l'appareil en présence de substances inflammables.
- Pour raccorder la ligne d'alimentation utiliser le boîtier de connexion spécifique (UPTJBUL). Pour plus d'informations, se référer au manuel d'utilisation et d'installation du produit.

- Ne pas laisser l'appareil à portée des enfants ou de personnes non autorisées.
- L'entretien du dispositif doit uniquement être effectué par un personnel qualifié. Durant les opérations d'entretien, l'opérateur est exposé au risque d'électrocution ou autres.
- Utiliser uniquement les accessoires indiqués par le fabricant. Toute modification non approuvée expressément par le fabricant entraînera l'annulation de la garantie.
- Brancher à la terre le câble coaxial.
- Avant de brancher tous les câbles de signalisation, vérifier que l'unité est correctement branché à la terre.
- En cas de transfert du dispositif de l'installation, toujours débrancher le câble de terre en dernier.
- Adopter les précautions utiles pour éviter d'endommager l'appareil à la suite de décharges électrostatiques.
- L'unité a été réalisée pour un branchement avec câble tri-polaire. Se conformer aux indications fournies dans ce manuel pour un branchement correct du circuit de terre.
- Manipuler avec soin l'unité, toute sollicitation mécanique importante risque de l'endommager.
- Accorder une attention particulière aux distances d'isolement entre la ligne d'alimentation et tous les autres câbles, dispositifs de protection contre la foudre compris.
- En cas de transport du dispositif, faire preuve d'une attention extrême. Tout arrêt brusque, dénivellations et chocs violents risque de l'endommager et d'entraîner des blessures.

4 Identification

4.1 Description et désignation du produit

ULISSE MAXI est une robuste et efficace unité PTZ conçue pour assurer une surveillance dynamique et non-stop de grands espaces extérieurs et résister à des conditions météorologiques difficiles.

Ce modèle peut contenir et gérer les objectifs motorisés les plus volumineux sur le marché, jusqu'à près de 8 kg de poids total.

Une seule unité peut ainsi assurer une large couverture à 360° de la zone à surveiller.

Pour garantir des images détaillées, même pendant la nuit, les versions avec des projecteurs à LED sont disponibles, avec lumière infrarouge ou lumière blanche.

La robuste structure mécanique et les puissants moteurs de ce PTZ sont étudiés pour garantir la plus grande résistance à un stress de fonctionnement élevé, aux vibrations et aux températures de -10°C à +60°C.

L'unité est équipée de senseurs optiques qui assurent le contrôle précis de la position dans n'importe quelle condition d'utilisation.

L'unité est équipée d'un essuie-glace pour le nettoyage de la vitre avant, de la pluie et de la poussière ; un vaste choix de jerrycans est disponible avec pompe lave-glace ayant des capacités et des hauteurs manométriques différentes.

Les modèles pour la vision avec caméra thermique sont disponibles.

4.2 Marquage du produit

i Les tourelles portent un étiquette conforme au marquage CE.

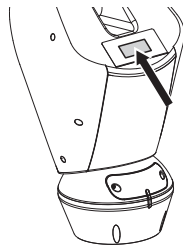

Fig. 1

L'étiquette indique:

- Code d'identification du modèle (Code barres Extended 3/9).
- Tension d'alimentation (Volt).
- Fréquence (Hertz).
- Courant absorbé (Ampères).
- Étanchéité (IP).
- Numéro de série.

4.2.1 Contrôle du marquage

Avant de procéder à l'installation, contrôler que le matériel fourni correspond à la commande et examiner les étiquettes de marquage.

Ne procéder sous aucun prétexte à des modifications ou des connexions non prévues dans ce manuel. L'utilisation d'appareils non adéquats peut comporter des dangers graves pour la sécurité du personnel et de l'installation.

5 Versions

5.1 Projecteurs à LED

⚠ La version avec projecteurs à LED peut être alimentée uniquement en 24Vac.

La tourelle peut être munie d'un support pour l'utilisation de 2 projecteurs à LED VIDEOTEC pour vision nocturne (projecteurs à prévoir en plus).

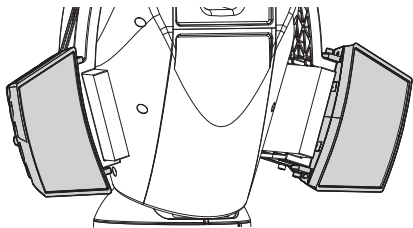

Fig. 2

i Pour d'autres renseignements se référer à le chapitre relatif (8.8 Montage des projecteurs à LED, page 28).

5.2 Fenêtre au germanium

La version équipée d'une fenêtre au germanium, est prévue pour protéger les caméras thermiques des agressions climatiques extérieures.

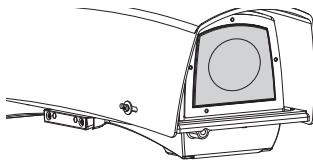

Fig. 3

6 Préparation du produit en vue de l'utilisation

! Toute modification non approuvée expressément par le fabricant entraînera l'annulation de la garantie.

! L'unité ne doit être ni démontée ni altérée. Les seules exceptions concernent les opérations de montage et d'entretien prévues dans ce manuel.

6.1 Précautions de sécurité avant l'utilisation

! L'appareil comprend des parties mobiles. S'assurer que l'unité est positionnée dans une zone non accessible pendant le fonctionnement. Appliquer l'étiquette fournie avec l'appareil près de l'objet et en position visible.



Fig. 4

6.2 Déballage

Lors de la livraison du produit, vérifier que l'emballage est en bon état et l'absence de tout signe évident de chute ou d'abrasion.

En cas de dommages évidents, contacter immédiatement le fournisseur.

Conserver l'emballage en cas de nécessité d'expédition du produit pour réparation.

i Déballer le toit pare-soleil du dispositif en ayant soin de ne pas endommager le caisson.

6.3 Contenu

Contrôler que le contenu correspond à la liste matériel indiquée ci-dessous:

- Unité de positionnement
- Base d'alimentation
- Emballage des accessoires:
 - Adaptateur sériel
 - Rallonge sérielle
 - Clés Allen
 - Entretoises
 - Entretoises (pas présents dans la version avec caméra intégrée)
 - Étiquette
 - Colliers
 - Gaine en silicone
 - Joints de réduction pour presse-étoupes
 - Manuel d'instructions
 - Plaque de fixation pour sachet déshydratant
 - Sachet déshydratant
 - Vis
- Emballage des contrepoids:
- Étrier pour la fixation des projecteur à LED (présent dans les versions avec projecteurs à LED)
 - Contrepoids
 - Supports pour contrepoids
- Double toit

6.4 Élimination sans danger des matériaux d'emballage

Le matériel d'emballage est entièrement composé de matériaux recyclables. Le technicien chargé de l'installation est tenu de l'éliminer conformément aux dispositions en matière de collecte sélective et selon les normes en vigueur dans le pays d'utilisation.

En cas de retour du produit défectueux, il est conseillé d'utiliser l'emballage original pour le transport.

6.5 Opérations à effectuer avant l'installation

6.5.1 Fixation du support

⚠ En cas d'installations soumises aux vibrations, utiliser seulement le support fixation sol.

Plusieurs types de supports sont disponibles (11 Accessoires, page 52). Choisir le support convenable à l'installation et suivre toutes les instructions dans le chapitre suggéré.

⚠ Accorder une attention particulière aux systèmes de fixation de l'appareil. Le système de fixation doit être tout de même être en mesure de supporter au moins 4 fois le poids de tout l'appareil, y compris la tourelle, les objectifs et les caméras.

⚠ L'appareil doit être monté en position verticale. Tout autre position compromettrait le bon fonctionnement du système.

⚠ Il est impératif de ne pas monter la tête en bas.

6.5.2 Passage des câbles

⚠ Les câbles de connexion ne doivent pas être accessibles de l'extérieur. Les câbles doivent être fixés au support pour éviter que le poids excessif n'entraîne leur sortie accidentelle.

⚠ Les câbles utilisés doivent être conformes au type d'installation.

Passer les câbles à l'intérieur du support jusqu'à ce qu'ils dépassent d'environ 50cm.

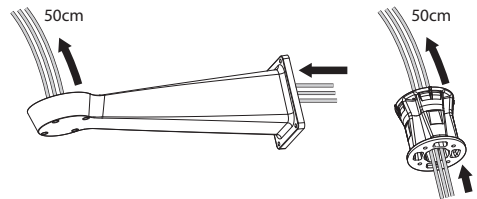

Fig. 5

7 Assemblage

7.1 Fixation du double toit

Fixer le toit pare-soleil au caisson au moyen des 4 vis et des 4 couples de rondelles fournies.

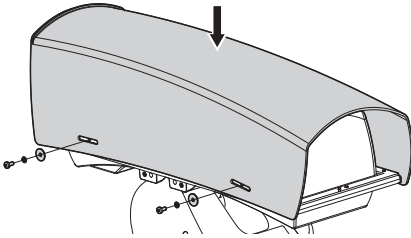

Fig. 6

7.2 Ouverture du caisson

Dévisser les vis anti-fuite situées sur les côtés et soulever la partie supérieure du caisson.

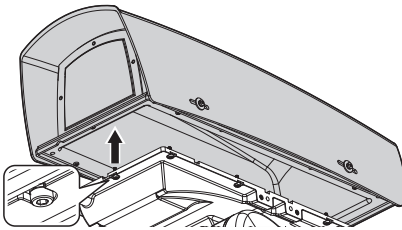

Fig. 7



Au terme des opérations d'installation et de câblage, refermer le produit.

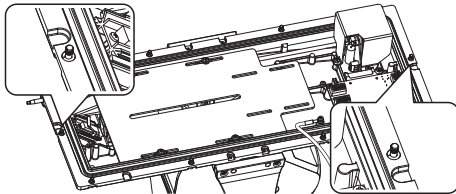

Fig. 8



D'abord serrer les vis centrales comme illustré en figure.

7.3 Montage caméras, systèmes optiques motorisés

Le montage de la caméra et des objectifs correspondants est laissé aux soins du client.

7.3.1 Caractéristiques des caméras



Le bon fonctionnement de l'unité, à l'intérieur de l'intervalle de température indiqué, est garanti uniquement si la caméra et le système optique sont utilisés avec un intervalle de température égal à min. -10°C et +60°C.

- La tension d'alimentation de la caméra doit être de 12Vdc.
- Le courant maximum absorbé par la caméra doit être inférieur à la valeur indiquée ci-après: 800mA.
- Le signal vidéo en sortie de la caméra doit être du type composite avec amplitude 1Vpp (sync négatif).

7.3.2 Fixation de l'optique et de la caméra à la glissière interne

⚠ Il est nécessaire d'isoler le corps de la caméra de la glissière de fixation pour éviter toute perturbation du signal vidéo.

⚠ Le poids total maximal autorisé pour la caméra et l'objectif ne doit pas dépasser le 7.6kg.

Connecter la caméra (02) à l'optique (01).

Fixer l'étrier à L en aluminium (03) à la caméra avec la rondelle en nylon (04) et de la vis de 1/4" (05).

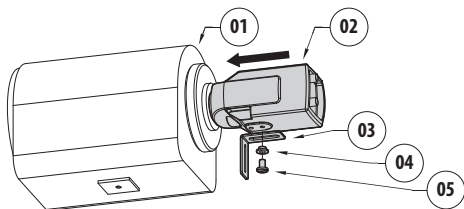

Fig. 9

Positionner l'optique sur la glissière (02) en intercalant l'entretoise en plastique (01). Fixer le tout avec la rondelle en nylon (03) et la vis de 1/4" (04).

Si nécessaire, utiliser les entretoises supplémentaires pour positionner correctement la caméra et l'optique.

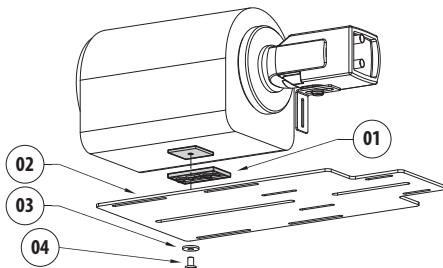

Fig. 10

Fixer la plaque en aluminium (01) sur la glissière au moyen des vis et de leurs rondelles (02).

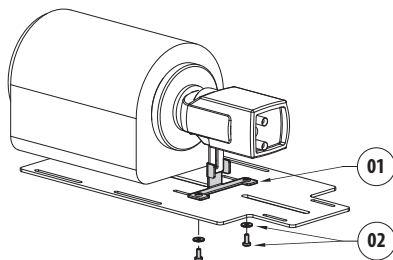

Fig. 11

Fixer l'étrier de fixation en L avec la vis.

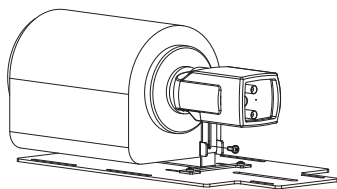

Fig. 12

7.3.3 Positionnement de l'entretoise H-20 sur la glissière interne

Il est possible de fixer une entretoise H-20 (02) au système optique. Connecter la caméra et fixer l'étrier à L (Fig. 9, page 15). Interposer une entretoise en plastique (01) de l'épaisseur requise et le fixer avec rondelle et vis (03).

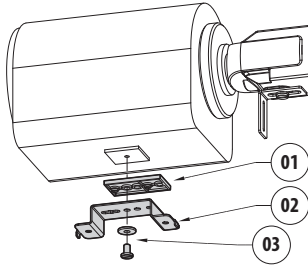

Fig. 13

Positionner l'optique avec l'entretoise dans la glissière interne (01) et fixer l'entretoise avec les rondelles et les vis (02) fournies.

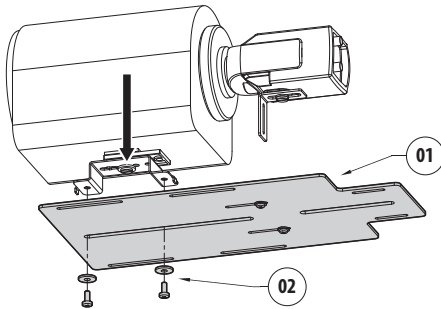

Fig. 14

Terminer le fixage comme représenté dans les images (Fig. 11, page 15 e Fig. 12, page 15).

7.3.4 Glissière interne

Faire glisser la glissière interne avec l'optique et la caméra déjà fixées en position et la fixer avec les rondelles et les vis fournies.

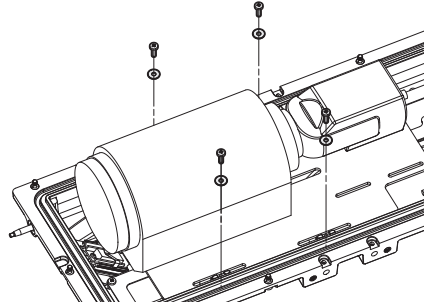

Fig. 15

7.4 Description de la carte du caisson

DESCRIPTION DE LA CARTE	
Connecteur/Borne	Fonction
CN1	Connecteur BNC, signal vidéo de la caméra
CN2	Connecteur contrôle moteurs optiques motorisés
CN3	Connecteur potentiomètres optiques motorisés
CN6	Connecteur sériel pour le contrôle de la caméra
CN7	Alimentation caméra, contact sec pour l'activation de la modalité Day/Night de la caméra, lignes additionnelles
DIP1	Configuration de la tension d'alimentation des optiques

Tab. 1

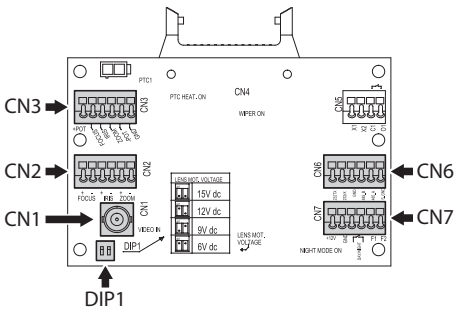

Fig. 16

7.4.1 Branchement de la caméra et de l'optique motorisée

⚠ Tous les branchements illustrés ci-après doivent exclusivement être exécutés par des installateurs experts et toutes les spécifications de câblage et d'alimentation des dispositifs doivent être respectées.

La carte électronique est prévue pour contrôler les caméras avec optiques motorisées, éventuellement équipées de potentiomètres pour le contrôle de la position atteinte.

⚠ Avant de procéder aux branchements, vérifier que les tensions fournies par la carte sont dans les limites prévues pour l'appareil.

CONNECTEUR CAMÉRA/OPTIQUES MOTORISÉES		
Tension	Courant	Description
+12V	800mA max	Alimentation caméra
+5V	15mA max	Alimentation potentiomètres optiques
De 6Vdc jusqu'à 15Vdc (réglable)	200mA max (Focus+Zoom+Iris)	Alimentation moteurs optiques

Tab. 2

Objectifs avec moteurs à inversion de polarité:
Effectuer les connexions comme montré sur la figure..

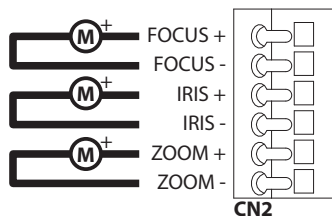

Fig. 17 CN2.

Objectifs avec moteurs à fil commun: Effectuer les connexions comme montré sur la figure..

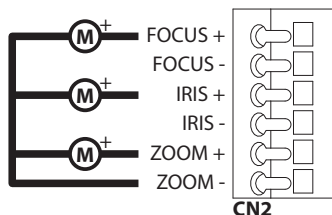

Fig. 18 CN2.

Potentimètres: Effectuer les connexions comme montré sur la figure..

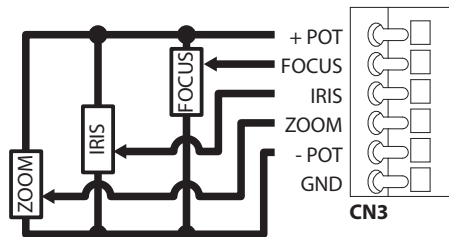

Fig. 19 CN3.

Caméra: Effectuer les connexions comme montré sur la figure..

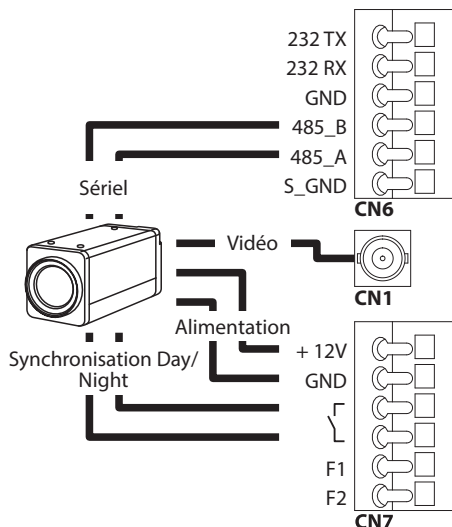

Fig. 20

Pour valider le contrôle de la caméra, consulter le chapitre correspondant (10.1.6 Menu Communication Sériele Caïsson, page 45).

7.4.2 Réglage de la tension d'alimentation des moteurs des optiques

Avant d'alimenter la tourelle, sélectionner la tension d'alimentation des optiques en agissant sur le DIP1 (7.4 Description de la carte du caïsson, page 17).

RÉGLAGE DE LA TENSION D'ALIMENTATION DES MOTEURS DES OPTIQUES		
SW1	SW2	Tension
OFF	OFF	15Vdc
ON	OFF	12Vdc
OFF	ON	9Vdc
ON	ON	6Vdc

Tab. 3

8 Installation

⚠ Ne procéder sous aucun prétexte à des modifications ou des connexions non prévues dans ce manuel. L'utilisation d'appareils inadéquats peut comporter des risques sérieux pour les appareils et la sécurité du personnel.

⚠ Ne pas modifier les câblages du produit. La non observation de cette indication peut entraîner des risques graves pour la sécurité du personnel de l'installation et annuler la garantie.

i En cas d'utilisation du kit de lavage du vitre, le support pour la buse doit être installé avant le positionnement de la tourelle et des câblages. Pour plus d'informations, se référer au manuel du kit correspondant.

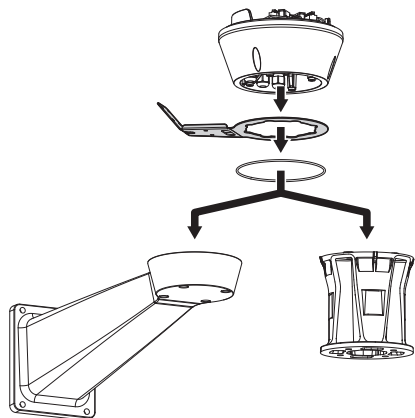

Fig. 21

i La calotte inférieure contient un sachet déshydratant qui permet d'éviter la formation d'humidité dans la base et à hauteur des cartes des connecteurs. Enlever le sachet avant l'installation.

8.1 Connexion des câbles à la base

Passer les câbles dans les presse-câbles en maintenant la base à environ 20cm du support. Serrer les presse-étoupes. Les presse-étoupes sont adaptés pour câbles avec un diamètre compris entre 5mm et 10mm.

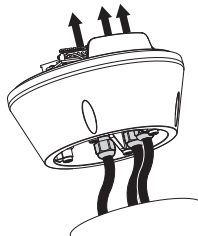

Fig. 22

⚠ Faire attention pendant la fixation. Couple de serrage: 5Nm.

i Pour de cables de diamètre de 3mm à 7mm utiliser les joints en dotation.

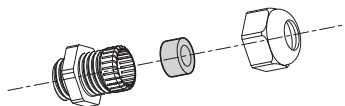

Fig. 23

8.2 Fixage de la base au support



Utiliser les vis et les rondelles fournies avec la base.

Après avoir positionné le joint (01), fixer la base (02) au support (03) en utilisant les vis (04), les rondelles à dents (05) et les bagues pour vis (06).

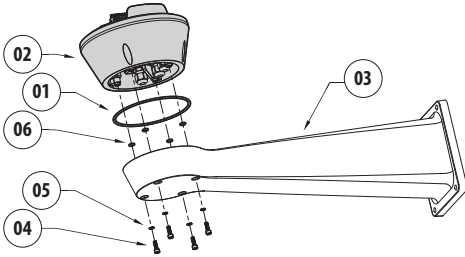

Fig. 24

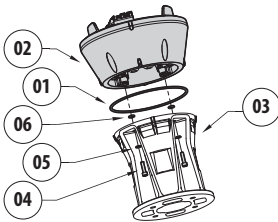

Fig. 25

Aligner les 3 encoches de la base avec celles des supports comme sur la figure suivante.

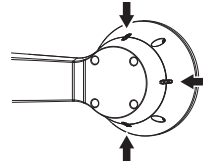

Fig. 26



Appliquer sur les trous des vis un produit de freinage du filet (Loctite 243®).



Faire attention pendant la fixation. Couple de serrage: 6Nm.

Tab. 4

8.3 Description de la carte de connexion

DESCRIPTION DE LA CARTE DE CONNEXION	
Connecteur/ Composant	Fonction
J6	Alimentation de la carte
J7	Câbles de signal
J4	RS-232
F1	Fusible
F2	Fusible

Tab. 5 Version standard.

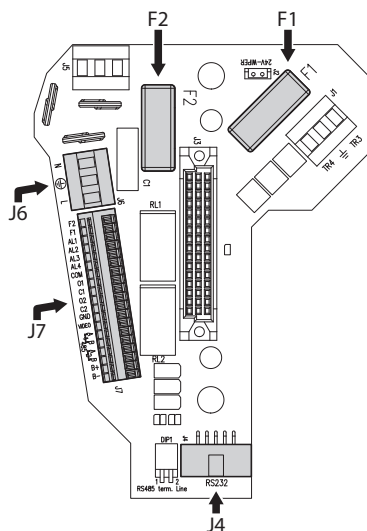

Fig. 27 Version standard.

DESCRIPTION DE LA CARTE DE CONNEXION	
Connecteur/ Composant	Fonction
J6	Alimentation de la carte
J7	Câbles de signal
J4	RS-232
F1	Fusible
F2	Fusible

Tab. 6 Version avec projecteurs à LED.

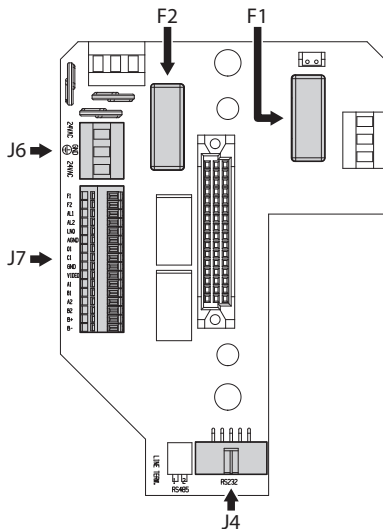

Fig. 28 Version avec projecteurs à LED.

8.4 Connexion de la ligne d'alimentation

Selon la version, différentes tensions d'alimentation peuvent être fournies au dispositif. La valeur de tension d'alimentation est reportée sur l'étiquette d'identification du produit (4.2 Marquage du produit, page 10).

⚠ Il faut effectuer les connexions électriques en absence d'alimentation et lorsque le dispositif de sectionnement ouvert.

⚠ Contrôler que les sources d'alimentation et les câbles de branchement sont en mesure de supporter la consommation du système.

⚠ Vérifier que la source et le câble d'alimentation sont adéquatement dimensionnés.

⚠ Le câble de terre doit être plus long des deux autres d'environ 10mm pour éviter tout détachement accidentel.

⚠ Le câble d'alimentation doit en outre être couvert de la gaine en silicone (01) fournie. La gaine en silicone doit être fixée au moyen du collier prévu (02).

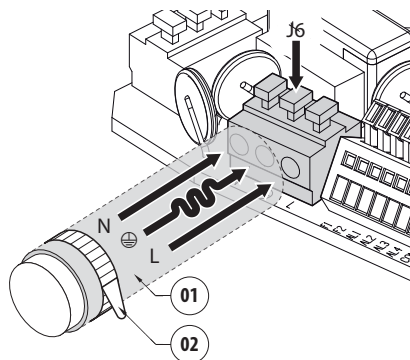

Fig. 29

8.4.1 Connexion de la ligne d'alimentation en 24Vac

Couper les câbles à la longueur nécessaire et procéder aux connexions. Connecter la ligne d'alimentation avec la borne: J6.

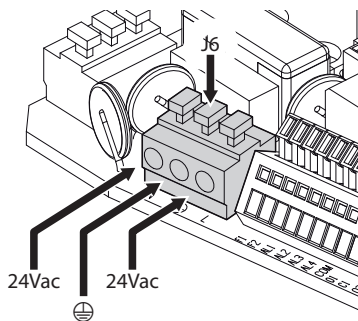

Fig. 30 Version standard.

8.4.2 Raccordement de la ligne d'alimentation en 120Vac et 230Vac

Couper les câbles à la longueur nécessaire et procéder aux connexions. Connecter la ligne d'alimentation avec la borne: J6.

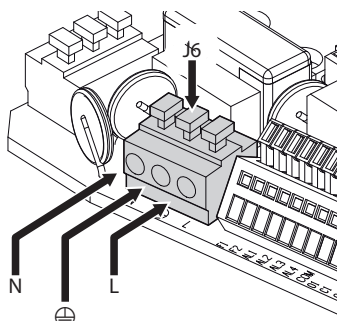

Fig. 32 Version standard.

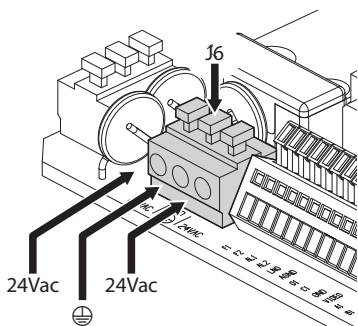

Fig. 31 Version avec projecteurs à LED.

Connecter les câbles d'alimentation comme décrit dans le tableau ci-dessous.

CONNEXION DE LA LIGNE D'ALIMENTATION	
Couleur	Bornes
Alimentation 24Vac	
Défini par l'installateur	24Vac
Défini par l'installateur	24Vac
Jaune/Vert	⊕

Tab. 7

Connecter les câbles d'alimentation comme décrit dans le tableau ci-dessous.

CONNEXION DE LA LIGNE D'ALIMENTATION	
Couleur	Bornes
Alimentation 230Vac	
Bleue	N (Neutre)
Marron	L (Phase)
Jaune/Vert	⊕
Alimentation 120Vac	
Bleue	N (Neutre)
Marron	L (Phase)
Jaune/Vert	⊕

Tab. 8

8.5 Connexion des câbles de signalisation

! Tous les câbles de signalisation doivent également être regroupés avec un collier.

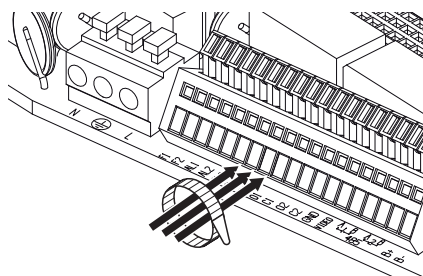

Fig. 33

8.5.1 Connexion du câble vidéo

! ATTENTION! Pour réduire les risques d'incendie, utiliser uniquement des câbles certifiés UL Listed ou CSA de sections égales ou supérieures à 0.14mm^2 (26AWG).

! L'installation est du type CDS (Cable Distribution System). Ne pas la connecter à des circuits SELV.

! Connecter l'écran et le câble central respectivement aux bornes GND et VIDEO. Les bornes acceptent des câbles d'une section comprise entre 0.5mm^2 (20AWG) et 0.08mm^2 (28AWG).

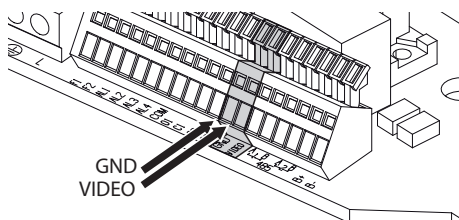

Fig. 34 Version standard.

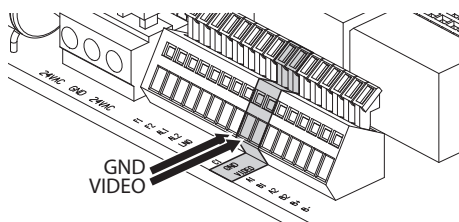

Fig. 35 Version avec projecteurs à LED.

8.5.2 Connexion des lignes de télémétrie

ATTENTION! L'installation est du type TNV-1. Ne pas la connecter à des circuits SELV.

ATTENTION! Pour réduire les risques d'incendie, utiliser uniquement des câbles certifiés UL Listed ou CSA de sections égales ou supérieures à 0.14mm² (26AWG).

Le produit prévoit deux lignes sérielles de communication RS-485 et une ligne sérielle RS-232 (seulement pour mise à jour du firmware).

Les lignes de télémétrie pouvant être configurés de différentes façons en fonction de la position des dip-switch 10 et 9 du sélecteur Sériels et Adresse (8.14.4.2 Configuration des lignes de communications sérielles, page 35).

Lignes sérielles RS-485

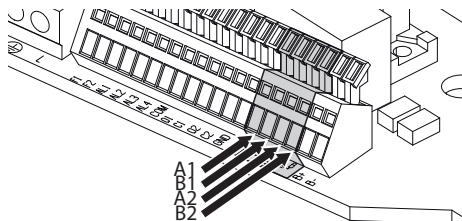

Fig. 36 RS-485. Version standard.

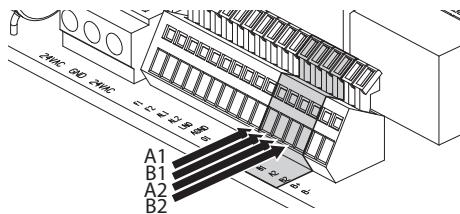

Fig. 37 RS-485. Version avec projecteurs à LED.

CONNEXION DES LIGNES DE TÉLÉMÉTRIE

Bornes	Description
A1-B1	Ligne RS-485 (1)
A2-B2	Ligne RS-485 (2)

Tab. 9

Ligne sérielle RS-232

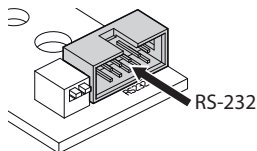

Fig. 38 RS-232.

8.5.3 Branchement des entrées d'alarme, de l'interrupteur crépusculaire et des relais



ATTENTION! L'installation est du type TNV-1. Ne pas la connecter à des circuits SELV.



ATTENTION! Pour réduire les risques d'incendie, utiliser uniquement des câbles certifiés UL Listed ou CSA de sections égales ou supérieures à 0.14mm² (26AWG).

Version standard

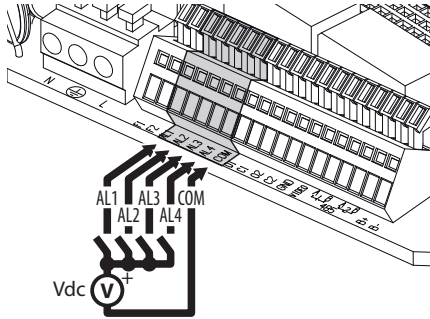

Fig. 39 Entrées d'alarme.

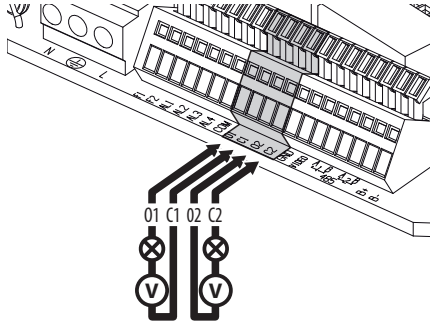

Fig. 40 Relais.

CONNEXION DES ENTRÉES D'ALARME ET DES RELAIS

Bornes	Description
AL1, AL2, AL3, AL4 e COM	Entrées d'alarme contrôlées en tension relatives à la borne commune COM
F1-F2	Destiné à une utilisation future
O1-C1 e O2-C2	Contacts secs de sortie activantes par alarme ou commande utilisateur

Tab. 10 Version standard.

Version avec projecteurs à LED

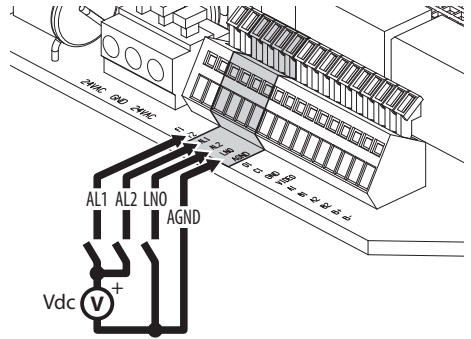

Fig. 41 Entrées d'alarme et interrupteur crépusculaire.

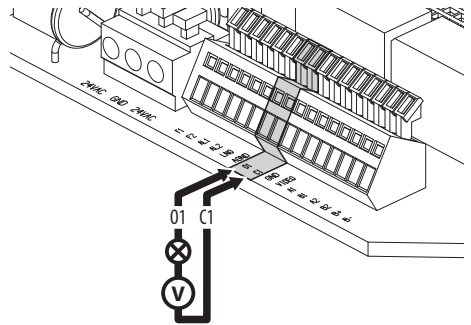

Fig. 42 Relais.

BRANCHEMENT DES ENTRÉES D'ALARME, DE L'INTERRUPTEUR CRÉPUSCULAIRE ET DES RELAIS

Bornes	Description
AL1, AL2 e AGND	Entrées d'alarme contrôlées en tension relatives à la borne commune AGND.
F1-F2	Destiné à une utilisation future
LNO e AGND	Interrupteur crépusculaire (contact sec)
O1-C1	Contacts secs de sortie activantes par alarme ou commande utilisateur

Tab. 11 Version avec projecteurs à LED.

8.6 Fixation du corps supérieur

Fixer le corps supérieur (01) à la base (02) au moyen des vis de fixation (03) pourvues de joints (04). Contrôler que le joint de la base est en place et en bon état (05).

⚠ **Faire attention pendant la fixation. Couple de serrage: 4Nm.**

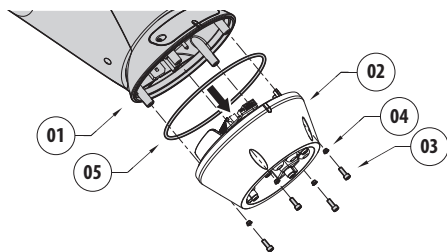

Fig. 43

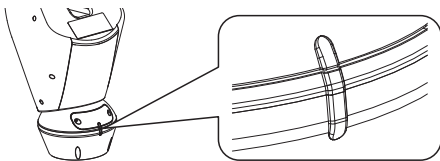

Fig. 44

i **Une seule position de fixation entre la base et le corps supérieur est possible. Aligner les saillies latérales pour s'assurer que le positionnement soit correct.**

8.7 Montage du contrepois

Fixer les contrepois au caisson au moyen des vis et des rondelles fournies.

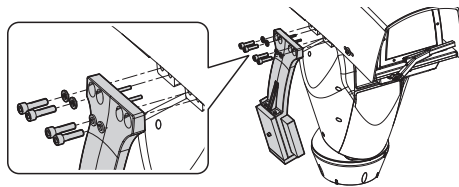

Fig. 45

⚠ **Appliquer sur les trous des vis un produit de freinage du filet (Loctite 243®).**

⚠ **Faire attention pendant la fixation. Couple de serrage: 16Nm.**

8.8 Montage des projecteurs à LED

! Pour en correct fonctionnement les deux projecteurs doivent toujours être montés ensemble.

i Seuls des projecteurs VIDEOTEC peuvent être installés sur la tourelle.

8.8.1 Retrait des contrepoids

Dévisser les vis et retirer les contrepoids externes.

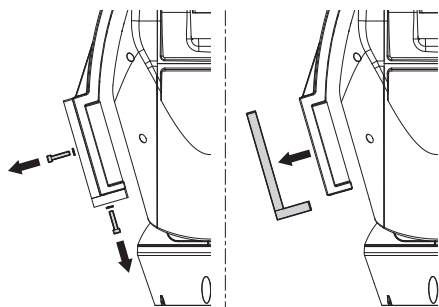

Fig. 46

8.8.2 Montage du projecteur sur l'étrier

Repérer les trous antérieurs présents sur l'étrier du contrepoids.

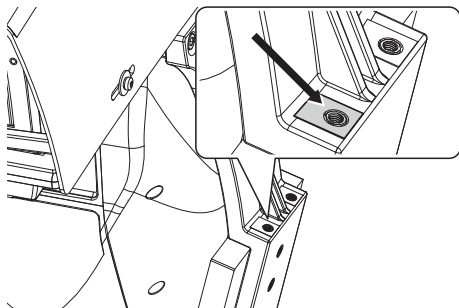

Fig. 47

Positionner les fixations du projecteur (01) sur celles de l'étrier (02).

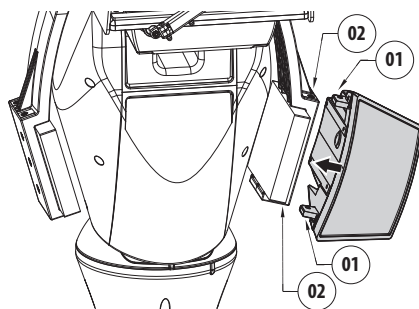

Fig. 48

Visser les vis et les rondelles enlevées auparavant.

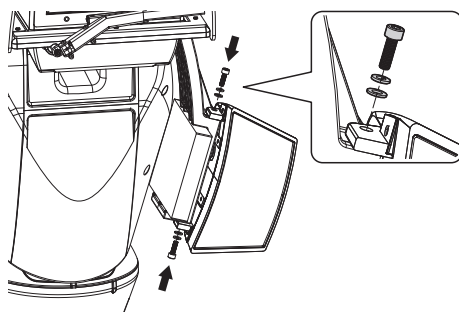

Fig. 49

! Faire attention pendant la fixation. Couple de serrage: 6Nm.

8.9 Branchement des projecteur à LED

Retirer les 2 bouchons M12. Visser les 2 presse-étoupes et les joints toriques correspondants, fournis avec l'appareil.

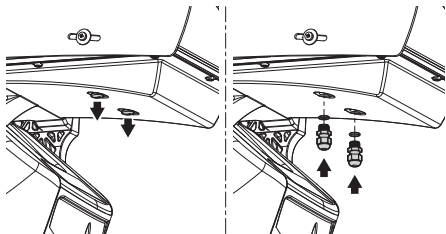

Fig. 50

⚠ Pour garantir la sécurité et le fonctionnement de l'unité, ne pas laisser du câble excédentaire à l'extérieur.

Fig. 51

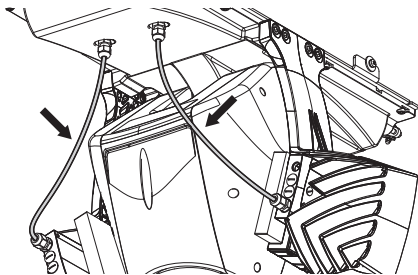

Fig. 52

Brancher les câbles comme illustré en figure.

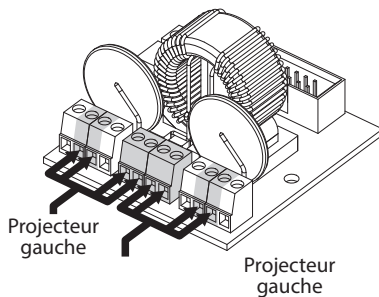

Fig. 53

BRANCHEMENT DES PROJECTEUR À LED			
Projecteur gauche		Projecteur gauche	
Référence sur la carte	Couleur du câble	Référence sur la carte	Couleur du câble
WH	Blanc	WH	Blanc
BK	Noir	BK	Noir
A1	Vert	A2	Vert
B1	Rouge	B2	Rouge

Tab. 12

8.10 Connexion pour la synchronisation des caméras avec les projecteurs à LED

Caméras ZFI équipées d'un filtre infrarouge:

Connecter l'entrée de commutation entre les modes Day/Night de la caméra au connecteur Night Mode (contact propre) comme illustré en figure.

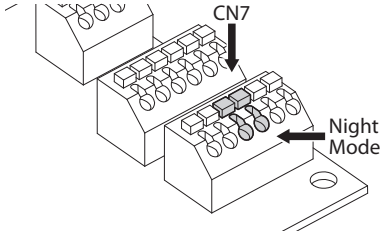

Fig. 54

8.11 Sachet déshydratant

Introduire les sachets déshydratants (01) dans les positions indiquées sur la figure après les avoir retirés de leur emballage transparent et pliés en deux. Fixer les sacs au moyen des platines (02) et des vis fournies (03).

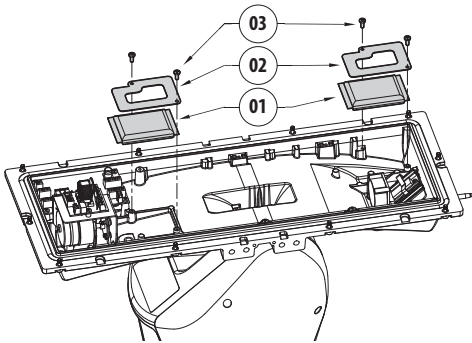

Fig. 55

8.12 Réglage et modalité d'activation des projecteurs à LED

Une fois effectué le réglage, le projecteur de gauche (MASTER) synchronise et contrôle le projecteur de droite (SLAVE).

L'interrupteur crépusculaire détecte la lumière ambiante et gère l'allumage et l'extinction des projecteurs lorsque la luminosité atteint le niveau réglé par l'utilisateur.

Lorsque les projecteurs LED sont allumés un signal de commutation Day/Night est envoyé à la caméra. (8.10 Connexion pour la synchronisation des caméras avec les projecteurs à LED, page 30).

8.12.1 Description du projecteur à LED

⚠ Pour ne pas compromettre la sécurité et le fonctionnement du projecteur, ne pas enlever la vis transparente du capteur crépusculaire.

- **Capteur crépusculaire:** Détecte le niveau de luminosité.
- **Câble:** Alimentation et contrôle.
- **Régulateur du seuil d'allumage:** Le potentiomètre permet de régler le niveau de sensibilité pour l'allumage du projecteur.
- **Régulateur puissance infrarouges:** Le potentiomètre permet de régler la puissance du projecteur.

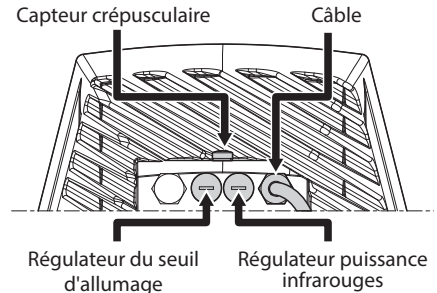

Fig. 56

8.12.2 Activation des projecteurs à LED à l'aide d'un interrupteur crépusculaire externe

Effectuer les opérations suivantes:

- Relier l'interrupteur crépusculaire aux bornes: LNO/AGND (8.5.3 Branchement des entrées d'alarme, de l'interrupteur crépusculaire et des relais, page 26).
- Régler le projecteur gauche (MASTER):
 - **Seuil d'allumage:** Configurer la valeur au minimum (8.12.4 Réglage du seuil d'allumage des projecteurs à LED, page 32).
 - **Puissance des infrarouges:** Configurer la valeur selon la nécessité (8.12.5 Réglage de la puissance des projecteurs à LED, page 32).
- Réglage du projecteur de droite (SLAVE):
 - **Seuil d'allumage:** Configurer la valeur au maximum (8.12.4 Réglage du seuil d'allumage des projecteurs à LED, page 32).
 - **Puissance des infrarouges:** Configurer la valeur au minimum (8.12.5 Réglage de la puissance des projecteurs à LED, page 32).
- Associer la valeur Externe à la rubrique Sonde IR du menu Paramètres ZFI (10.1.5 Menu Paramètres ZFI, page 42).

```

PARAMÈTRES ZFI
-----
1>ZOOM                :    30x

3 SONDE IR            :EXTERNE
4 TITRAGE DES ZONES  >
5 MASQUAGE DES ZONES >
  
```

Fig. 57

8.12.3 Activation des projecteurs à LED à l'aide du détecteur crépusculaire intégré

Pour synchroniser l'unité avec les projecteurs à LED, procéder comme suit:

- Régler le projecteur gauche (MASTER):
 - **Seuil d'allumage:** Configurer la valeur selon la nécessité (8.12.4 Réglage du seuil d'allumage des projecteurs à LED, page 32).
 - **Puissance des infrarouges:** Configurer la valeur selon la nécessité (8.12.5 Réglage de la puissance des projecteurs à LED, page 32).
- Réglage du projecteur de droite (SLAVE):
 - **Seuil d'allumage:** Configurer la valeur au maximum (8.12.4 Réglage du seuil d'allumage des projecteurs à LED, page 32).
 - **Puissance des infrarouges:** Configurer la valeur au minimum (8.12.5 Réglage de la puissance des projecteurs à LED, page 32).
- Associer la valeur Interne à la rubrique Sonde IR du menu Paramètres ZFI (10.1.5 Menu Paramètres ZFI, page 42).

```

PARAMÈTRES ZFI
-----
1>ZOOM                :    30x

3 SONDE IR            :INTERNE
4 TITRAGE DES ZONES  >
5 MASQUAGE DES ZONES >
  
```

Fig. 58

8.12.4 Réglage du seuil d'allumage des projecteurs à LED

⚠ Le projecteur de droite doit toujours être configuré à la luminosité maximum.

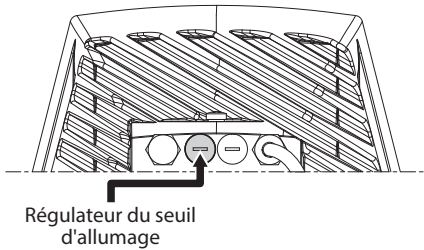

Fig. 59

Le projecteur a un capteur crépusculaire intégrée qui permet un allumage et un arrêt automatique à conditions lumineuses préétablies.

Le réglage du capteur crépusculaire est effectué en usine à un niveau lumineux fixé et approprié à la plupart des installations (environ 50lx). Si l'on souhaite régler différemment le seuil d'intervention, dévisser le bouchon situé à l'arrière du projecteur et effectuer le réglage avec un tournevis.

En tournant le bouton de réglage dans le sens des aiguilles d'une montre, la commutation en mode nocturne est avancée (à une valeur de luminosité supérieure.) En tournant le bouton de réglage dans le sens inverse des aiguilles d'une montre, la commutation en mode nocturne est retardée (à une valeur de luminosité inférieure.)

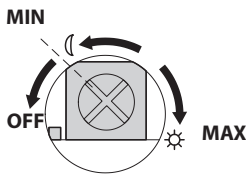

Fig. 60

Attendre les conditions de luminosité appropriées pour allumer le projecteur. Tourner lentement le trimmer jusqu'à ce que la LED présente sur le côté s'allume. Une fois que le seuil d'intervention (LED allumée) est dépassé, tourner légèrement dans le sens contraire.

⚠ Au terme des réglages, vérifier que le bouchon de fermeture soit bien serré pour garantir l'étanchéité hermétique du produit.

8.12.5 Réglage de la puissance des projecteurs à LED

⚠ Le projecteur de droite doit toujours être configuré à la puissance minimum.

Le projecteur est réglé en usine afin de distribuer la puissance maximale. S'il ne fallait pas éclairer des sujets éloignés ou si l'image était surexposée à cause de la luminosité excessive, effectuer le réglage de la puissance pour l'abaisser et pour obtenir une économie énergétique.

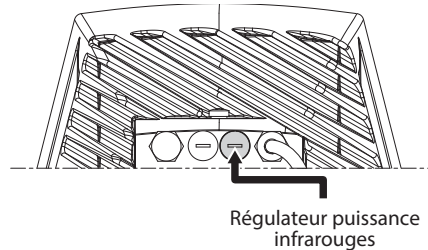

Fig. 61

Dévisser tout d'abord le bouchon de fermeture hermétique. Tourner le trimmer, dans le sens horaire pour augmenter la puissance des infrarouges et dans le sens antihoraire pour l'abaisser.

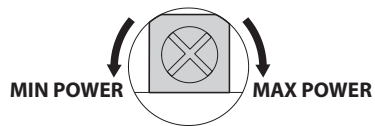

Fig. 62

⚠ Au terme des réglages, vérifier que le bouchon de fermeture soit bien serré pour garantir l'étanchéité hermétique du produit.

8.13 Fixation du balai essuie-glace

Insérer le balai sur l'arbre de l'essuie-glace

Placer le balai en position de repos.

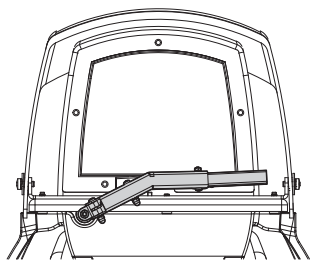

Fig. 63

Fixer l'ensemble avec rondelle dentée.

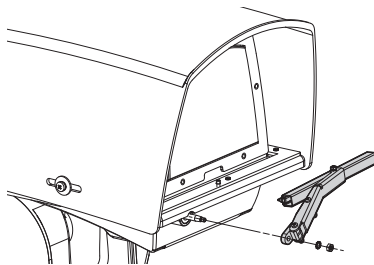

Fig. 64

i Un réglage correct doit permettre au balai de revenir en position de repos en entrant en contact avec la plaque de la structure.

8.14 Configuration du matériel

8.14.1 Ouverture du volet de configuration

Avant de mettre l'appareil sous tension, il est nécessaire de le configurer correctement au moyen des dip-switch installés derrière le panneau de configuration. Ouvrir le panneau de configuration en desserrant les vis comme illustré en figure.

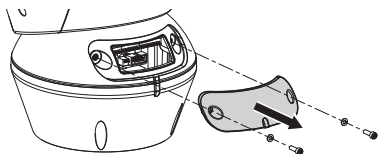

Fig. 65

Les DIP-switch sont montrés sur la figure.

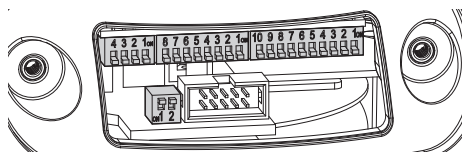

Fig. 66

i Au terme des opérations d'installation et de câblage, refermer le produit.

8.14.2 Configuration du DIP1

i Le levier du switch vers le haut représente la valeur 1 (ON). Le levier du dip-switch vers le bas représente la valeur 0 (OFF).

Le switch 1 est utilisé pour la mise à jour du micrologiciel.

Les switches 4, 3 et 2 permettent de sélectionner la vitesse de communication du dispositif.

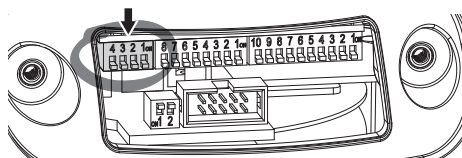

Fig. 67

CONFIGURATION DU DIP1					
Description	SW 4	SW 3	SW 2	SW 1	Baud rate
Réglage de la vitesse de transmission en bauds	OFF	OFF	OFF	-	300 baud
	ON	OFF	OFF	-	600 baud
	OFF	ON	OFF	-	1200 baud
	ON	ON	OFF	-	2400 baud
	OFF	OFF	ON	-	4800 baud
	ON	OFF	ON	-	9600 baud
	OFF	ON	ON	-	19200 baud
	ON	ON	ON	-	38400 baud
Mise à jour du firmware	-	-	-	ON	Programmation validée
	-	-	-	OFF	Programmation désactivée

Fig. 68

8.14.3 Configuration du DIP2

i Le levier du switch vers le haut représente la valeur 1 (ON). Le levier du dip-switch vers le bas représente la valeur 0 (OFF).

La tourelle est contrôlable à travers de différents protocoles.

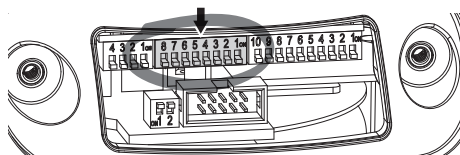

Fig. 69

CONFIGURATION DU DIP2								
Protocole	SW 8	SW 7	SW 6	SW 5	SW 4	SW 3	SW 2	SW 1
PTZ Manager ¹	OFF	OFF	OFF	OFF	OFF	OFF	OFF	OFF
MACRO (VIDEOTEC)	OFF	OFF	OFF	OFF	OFF	ON	ON	ON
PANASONIC	OFF	OFF	OFF	ON	OFF	ON	OFF	OFF
PELCO D	OFF	OFF	OFF	OFF	ON	OFF	OFF	ON
AMERICAN DYNAMICS	OFF	OFF	OFF	OFF	ON	ON	ON	OFF
VISTA	OFF	OFF	OFF	ON	OFF	OFF	ON	ON

Tab. 13 ¹ Configuration de défaut: MACRO (VIDEOTEC), 115200 baud, Adresse 1. Cette option ne nécessite pas le réglage du DIP-switch (DIP1, DIP3).

Tab. 14

8.14.4 Configuration du DIP3

i Le levier du switch vers le haut représente la valeur 1 (ON). Le levier du dip-switch vers le bas représente la valeur 0 (OFF).

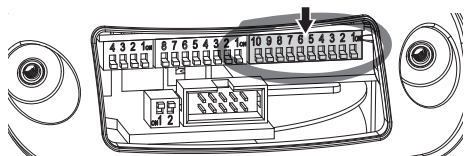

Fig. 70

8.14.4.1 Configuration de l'adresse

Les switch de 1 à 8 sont utilisés pour configurer l'adresse de l'unité (de 1 à 255).

La sélection de l'adresse s'effectue selon le code binaire (A Annexe - Tableau des adresses, page 66).

8.14.4.2 Configuration des lignes de communications sérieelles

Le produit prévoit deux lignes sérieelles de communication RS-485.

Les switch 10 et 9 sont utilisés pour configurer les lignes sérieelles.

CONFIGURATION DU DIP3		
Description	SW 10	SW 9
Communication monodirectionnelle sur la ligne RS-485-1.	OFF	OFF
Communication en half-duplex suivant le standard RS-422.	OFF	ON
Branchement de plusieurs dispositifs en cascade. Le signal est généré de nouveau par chaque unité.	ON	OFF
Communication bidirectionnelle, half-duplex, sur la ligne RS-485-1.	ON	ON

Tab. 15

i Pour d'autres renseignements se référer à le chapitre relatif (8.14.6 Exemple d'installation, page 36).

8.14.5 Configuration du DIP4

i La configuration de ce DIP s'effectue à l'inverse des DIP précédents. Le levier du switch vers le haut représente la valeur 0 (OFF). Le levier du dip-switch vers le bas représente la valeur 1 (ON).

Sur la carte, il y a deux switches, utilisés pour configurer la terminaison (120 Ohm) des lignes sérieelles.

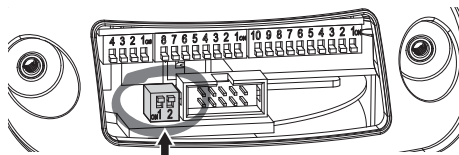

Fig. 71

Chaque unité en fin de ligne doit être terminée (bouclé) au moyen du switch prévu pour éviter tout phénomène de réflexion et de déformation du signal.

Les switches 1 et 2 terminent respectivement les lignes sérieelles RS-485-1 et RS-485-2.

CONFIGURATION DU DIP4			
Ligne sérieelle	SW 2	SW 1	Description
Ligne RS-485-1	-	ON	Terminée
	-	OFF	Non terminée
Ligne RS-485-2	ON	-	Terminée
	OFF	-	Non terminée

Tab. 16

8.14.6 Exemple d'installation

8.14.6.1 Ligne RS-485 RX

La ligne RS-485-1 fonctionne selon les programmations établies avec les dip-switches Adresse, Baud rate et Protocole.

La ligne sérielle RS-485-2 n'est pas utilisée.

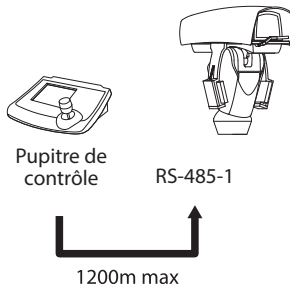

Fig. 72

ATTENTION! L'installation est du type TNV-1. Ne pas la connecter à des circuits SELV.

8.14.6.2 Ligne RS-422 (RS-485-1 RX e RS-485-2 TX)

Cette programmation permet la communication en full duplex selon le standard RS-422. Les deux lignes RS-485-1 et RS-485-2 sont donc utilisées.

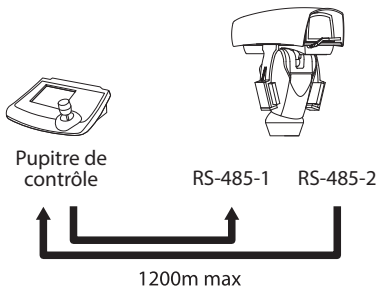

Fig. 73

i Cette fonction est uniquement disponible avec des protocoles bidirectionnels (exemple: PELCO, AMERICAN DYNAMICS, VIDEOTEC MACRO, etc.).

8.14.6.3 Ligne RS-485-1 réception, ligne RS-485-2 répétition

Ce type de configuration permet de connecter plusieurs dispositifs en cascade. Le signal est régénéré par chaque unité et permet d'augmenter sensiblement la distance totale.

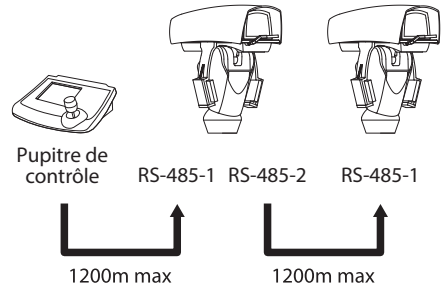

Fig. 74

i Cette configuration peut être utilisée exclusivement avec des protocoles monodirectionnels.

8.14.6.4 Ligne RS-485 TX/RX bidirectionnelle

Ce configuration permet d'obtenir une communication bidirectionnelle half-duplex sur la ligne RS-485-1.

La ligne sérielle RS-485-2 n'est pas utilisée.

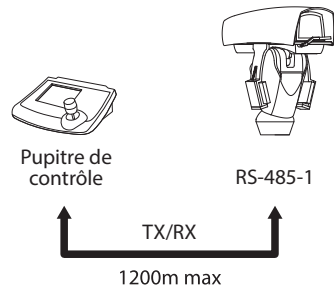

Fig. 75

i Cette fonction est uniquement disponible avec des protocoles bidirectionnels (exemple: PELCO, AMERICAN DYNAMICS, VIDEOTEC MACRO, etc.).

9 Allumage



S'assurer que l'unité et les autres composants de l'installation soient fermés de façon à empêcher le contact avec les composants sous tension.



Durant le fonctionnement normal, la surface du projecteur peut atteindre des températures élevées. Éviter le contact direct et positionner l'appareil dans un endroit non accessible au personnel non autorisé. Avant de la toucher, éteindre le dispositif d'illumination et le laisser refroidir durant 10 minutes minimum.



Ne pas rester en proximité de l'appareil lorsqu'il est sous tension. N'intervenir sur le dispositif que hors tension.



Ne pas stationner à proximité du dispositif sous tension. N'intervenir sur le dispositif qu'avec l'alimentation coupée.



La procédure de préchauffage automatique (De-Ice) peut être activée chaque fois que le dispositif est mis en fonction à une température ambiante inférieure à 0°C. La procédure permet de garantir un fonctionnement correct du dispositif également à basse température. La durée varie en fonction des conditions climatiques (de 60 minutes jusqu'à 105 minutes).

Il suffit de brancher l'alimentation électrique pour allumer l'unité.

Débrancher l'alimentation électrique pour éteindre l'unité.

9.1 Premier allumage

Lors de la première mise en service, toujours vérifier la configuration de l'appareil.

Avant de mettre le dispositif sous tension, enlever le volet de protection des DIP et mettre le levier du switch de mise à jour du firmware sur ON (allumé). (8.14.2 Configuration du DIP1, page 34).

Alimenter le dispositif. Quelques secondes après il sera possible de vérifier sur l'écran la configuration effectuée..

Le contrôle terminé, éteindre l'appareil et abaisser le levier du switch de mise à jour du micrologiciel.

Refermer le panneau et mettre l'appareil sous tension.

9.2 Liste des contrôles



Si l'une des commandes ne passe pas le test (ERR) contacter le service d'assistance. L'inscription OFF signifie que la tourelle n'est pas munie de l'option décrite.

Durante la phase d'allumage, le dispositif affiche la liste des contrôles qu'il doit effectuer avant de passer au fonctionnement normal.

STARTUP

```

-----
TEST FLASH           : OK
HOMING PROCEDURE    : OK
ZFI SEARCH           : OK
IO EXPANDER          : OFF
IR360 STATE         : OFF
  
```

Fig. 76

10 Configuration

10.1 Interface OSM (On Screen Menu)

10.1.1 Utilisation de l'OSM

Durant le fonctionnement normal de l'unité il est possible d'activer l'OSM pour sélectionner et configurer les fonctions avancées.. Pour plus d'informations se référer au manuel du pupitre utilisé et au chapitre relatif. (12.11 Commandes spéciales, page 56).

Quitter l'OSM avec Zoom Wide (Zoom-).

i Le menu se configure tout seul dynamiquement selon le modèle de tourelle.

10.1.1.1 Utilisation du joystick

Toutes les opérations des menus s'effectuent au moyen du manche à balai.

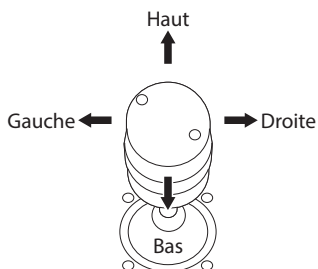

Fig. 77 Pan et tilt.

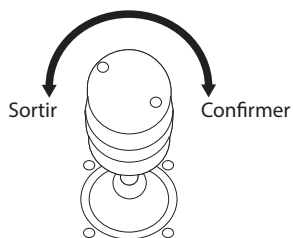

Fig. 78 Zoom Wide et Zoom Tele.

i En cas d'utilisation d'un pupitre de contrôle avec joystick à deux axes, utiliser les boutons de Zoom Wide et Zoom Tele pour exécuter les commandes Sortir et Confirmer.

10.1.1.2 Comment se déplacer dans le menu

Chaque page-écran du OSM présente une liste de paramètres ou de sous-menus pouvant être sélectionnés par l'opérateur. Pour faire défiler les différents paramètres déplacer le curseur en utilisant le joystick (haut et bas).

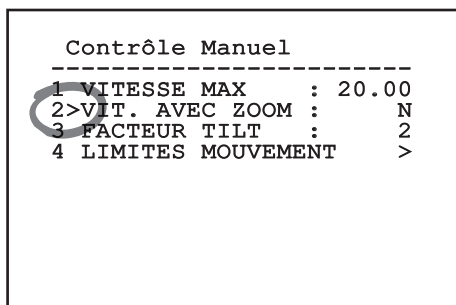

Fig. 79

Le symbole > en fin de ligne indique la présence d'un sous-menu spécifique. Pour l'activer, il suffit de confirmer la rubrique du menu. Pour sortir du sous-menu, utiliser la fonction Sortir (Zoom Wide).

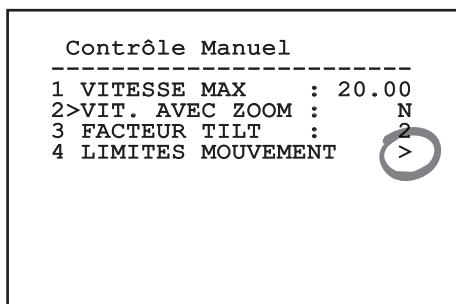

Fig. 80

10.1.1.3 Comment modifier les paramètres

Se déplacer au moyen du curseur sur le paramètre à modifier et confirmer. Le champ commence à clignoter pour indiquer la modification en cours. Pour afficher les options possibles déplacer le joystick (haut et bas)

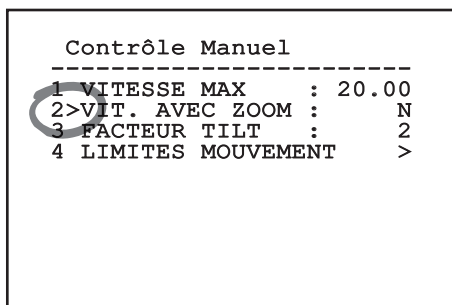

Fig. 81

Une fois l'option sélectionnée, confirmer.

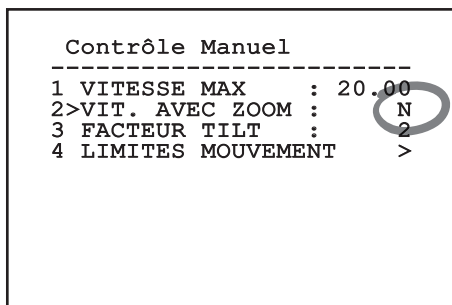

Fig. 82

Le champ cessera de clignoter en confirmant le choix effectué.

10.1.1.4 Comment modifier les champs numériques

Se déplacer au moyen du curseur sur le paramètre à modifier et confirmer.

```

MODIFIER PRESET
-----
1 NR.      :      1
2 ENAB.   :      N
3>PAN     : +  0.00
4 TILT    : - 40.00
5 VIT.    :  20.00
6 PAUSE   :      5
7 TEXTE:  PRESET 001
8 ALLER À PRESET?
  
```

Fig. 83

Le premier chiffre du champ numérique en cours de modification clignote et la dernière ligne de l'écran indique les limites d'acceptation du champ. Se déplacer sur le champ (gauche et droite) et modifier le signe ou la valeur numérique (haut et bas).

```

MODIFIER PRESET
-----
1 NR.      :      1
2 ENAB.   :      N
3>PAN     : +000.00
4 TILT    : - 40.00
5 VIT.    :  20.00
6 PAUSE   :      5
7 TEXTE:  PRESET 001
8 ALLER À PRESET?

min:-180.00 max:+179.99
  
```

Fig. 84

Une fois le résultat désiré obtenu, confirmer. Le curseur retournera vers la droite et la valeur modifiée cessera de clignoter. Si l'on essaye de saisir une valeur non prévue le champ sera forcé à la valeur minimale ou maximale autorisée.

10.1.1.5 Comment modifier les textes

Se déplacer au moyen du curseur sur le paramètre à modifier et confirmer.

```

MODIFICATION ZONE
-----
1 NR      :      1
2 START:+ 0.00
3 STOP :+ 0.00
4>TEXTE:TXT AREA1
  
```

Fig. 85

La page-écran de modification du texte s'affiche. Le symbole flèche se positionne sous le caractère modifiable tandis que le curseur > se positionne à gauche du caractère sélectionné.

```

EDIT TEXT: AREA
-----
Text: TEXT AREA1
      ↑
>A B C D E F G   ERASE
H I J K L M N   SAVE
O P Q R S T U   EXIT
V W X Y Z 0 1   abc
2 3 4 5 6 7 8
9 : ; , / ? !
\ + - * / = "
< > SPACE ← →
  
```

Fig. 86

Il est possible d'utiliser le joystick pour naviguer à l'intérieur du menu.

```

EDIT TEXT: AREA
-----
Text: TEXT AREA1
      ↑
A B C D E F G   ERASE
H I J K L M N   SAVE
O P Q>R S T U   EXIT
V W X Y Z 0 1   abc
2 3 4 5 6 7 8
9 : ; . / ? !
\ + - * / = "
< > SPACE ← →
  
```

Fig. 87

La commande Confirmer (Zoom Tele) permet d'insérer le caractère désiré.

```

EDIT TEXT: AREA
-----
Text: TEXT AREA1
      ↑
A B C D E F G   ERASE
H I J K L M N   SAVE
O P Q>R S T U   EXIT
V W X Y Z 0 1   abc
2 3 4 5 6 7 8
9 : ; . / ? !
\ + - * / = "
< > SPACE ← →
  
```

Fig. 88

Utiliser:

- **ERASE:** Supprimer toute la chaîne de texte.
- **SAVE:** Sauvegarder le nouveau texte avant de quitter le menu.
- **EXIT:** Quitter le menu.
- **abc:** Affiche les caractères en minuscule.

```

EDIT TEXT: AREA
-----
Text: TEXT AREA1
      ↑
A B C D E F G   >ERASE
H I J K L M N   SAVE
O P Q R S T U   EXIT
V W X Y Z 0 1   abc
2 3 4 5 6 7 8
9 : ; . / ? !
\ + - * / = "
< > SPACE ← →
  
```

Fig. 89

Pour sortir du menu, il est également possible d'utiliser la commande Zoom Wide.

10.1.2 Configuration par OSM

Les pages-écrans qui servent à configurer le produit sont illustrées ci-après.

10.1.3 Menu Principal

Le menu principal permet d'accéder à la configuration du dispositif.

MENU PRINCIPAL	

1>LANGUE	>
2 OPTIQUES ZFI	>
4 MOUVEMENT	>
5 GESTION ECRAN	>
6 I/O NUMÉRIQUES	>
7 DEFAULT	>
8 INFO	>

Fig. 90

Le menu se configure tout seul dynamiquement selon le modèle de tourelle.

10.1.4 Menu Choix Langue

Le menu permet de choisir la langue désirée.

MENU CHOIX LANGUE	

1>ITALIANO	
2 ENGLISH	
3 FRANCAIS	
4 DEUTSCH	

Fig. 91

10.1.5 Menu Paramètres ZFI

- Zoom:** Programme le nombre maximum d'agrandissements que peut effectuer l'optique motorisée.
- Fil Commun:** Si validé, il gère les optiques motorisées à fil commun, sinon, celles à inversion de polarité.
- Sonde IR:** Il signale la présence éventuelle d'un interrupteur crépusculaire pour la gestion Day/Night de l'optique motorisée. Trois options sont disponibles :
 - Off: Commutation Day/Night non activée.
 - Internal: L'interrupteur crépusculaire pour la commutation Day/Night se trouve à l'intérieur des projecteurs.
 - Externe: Connecter l'interrupteur crépusculaire pour la commutation Day/Night à la borne LNO.
- Titrage Des Zones:** Permet d'accéder au sous-menu pour la gestion du titrage des zones.
- Masquage des Zones:** Permet d'entrer dans le sous-menu pour la gestion du masquage des zones.
- Sérielle Caisson:** Permet d'entrer dans le sous-menu pour la gestion de la porte sérielle du caisson.
- Polarité:** Permet d'entrer dans le sous-menu pour la gestion des moteurs Zoom, Focus et Iris.

PARAMÈTRES ZFI		

1>ZOOM	:	30x
2 FIL COMMUN	:	N
3 SONDE IR	:	EXTERNE
4 TITRAGE DES ZONES		>
5 MASQUAGE DES ZONES		>
6 SÉRIELLE CAISSON		>
7 POLARITÉ		>

Fig. 92

10.1.5.1 Menu Titrage Des Zones

Cette fonction permet de configurer un maximum de huit zones (de dimensions variables) et éventuellement de les titrer.

Il permet de configurer les paramètres suivants :

Numéro: Sélectionne la zone à modifier.

Activation: Valide l'affichage sur l'écran du message associé à l'aire filmée.

Start: Configure la position initiale de la zone.

Stop: Configure la position finale de la zone.

Texte: Modifie le texte qui est affiché quand on se déplace à l'intérieur de l'aire.

GESTION AIRES			

1	>NR.	:	1
2	ENAB.	:	N
3	START:	+ 0.00	
4	STOP :	+ 0.00	
5	TEXTE:	ZONE 1	

Fig. 93

Exemple: Pour activer le titrage de la zone 1 quand le dispositif se trouve entre $+15^\circ$ et $+45^\circ$, procéder comme suit:

- Valider le titrage des zones en configurant O comme valeur de la rubrique Validation.
- Sélectionner 1 comme valeur du paramètre N°
- Configurer $+015.00$ comme valeur du paramètre Start.
- Programmer $+045.00$ comme valeur du paramètre Stop.
- Si nécessaire, modifier le texte affiché en sélectionnant la rubrique Texte.

i Si les valeurs de Start et Stop du menu sont à zéro, l'affichage du texte est désactivé. En cas de superposition de plusieurs zones, la zone portant le nombre le plus bas prévaut.

i Définir les zones en se déplaçant dans le sens des aiguilles d'une montre comme indiqué sur la figure.

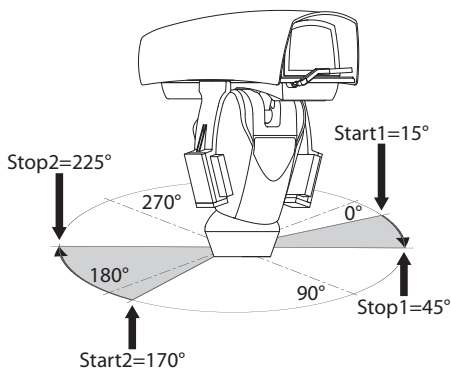

Fig. 94

10.1.5.2 Menu Masquage des Zones

Cette fonction permet de configurer un maximum de huit masques (de dimensions variables) et éventuellement de les titrer.

1. **Numéro:** Sélectionne la zone à modifier.
2. **Enabling:** Valide le masquage de l'aire filmée.
3. **Start:** Configure la position initiale de la zone.
4. **Stop:** Programme la position finale du masquage.
5. **Texte:** Modifie le texte qui est affiché quand le masquage est activé.

MASQUAGE DES ZONES		

1 >NR :		1
2 ENAB. :		N
3 START: +	0.00	
4 STOP : +	0.00	
5 TEXTE:	MASK	1

Fig. 95

Exemple: Pour activer le masquage de la zone 1 quand le dispositif se trouve entre +15° et +45° il faut:

- Sélectionner 1 comme valeur du paramètre N°
- Valider le masquage de l'aire en programmant O comme valeur de la rubrique Validation.
- Configurer +015.00 comme valeur du paramètre Start.
- Programmer +045.00 comme valeur du paramètre Stop.
- Si nécessaire, modifier le texte affiché en sélectionnant la rubrique Texte.

i En mettant les valeurs de Start et Stop du menu sur zéro, on exclut le masquage. En cas de superposition de plusieurs masquages, celui qui a le numéro le plus bas prévaut.

i Définir les masques en se déplaçant dans le sens des aiguilles d'une montre comme indiqué sur la figure.

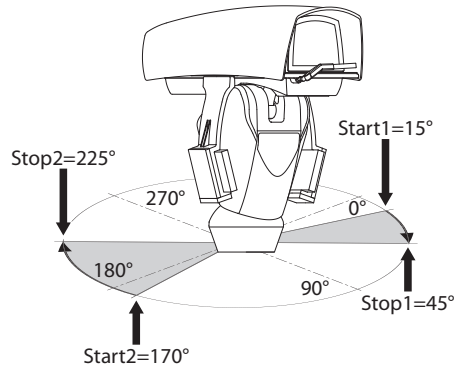

Fig. 96

10.1.6 Menu Communication Sérielle Caisson

i Après être sorti du OSM de la caméra, appuyer sur la touche Iris Close pour retourner au menu OSM de la tourelle.

i Afin d'éviter la superposition du OSM de la caméra avec le OSM de la tourelle, il faut sortir du mode de configuration de la caméra avant d'appuyer sur la touche Iris Close.

1. **Protocole:** Il permet de choisir le protocole à utiliser dans la sériele du caisson.
2. **Baud Rate:** Il permet de choisir le baud rate utilisé dans la sériele du caisson.
3. **Cmd Envoi:** Remplace la commande Confirmer envoyée à travers le joystick avec une commande personnalisée.
4. **Cmd Sortie:** Remplace la commande Sortir envoyée à travers le joystick avec une commande personnalisée.
5. **Activer OSM Caméra:** Permet d'entrer dans le mode de configuration de la caméra.

```

SÉRIELLE CAISSON
-----
1>PROTOCOLE : AUCUN
2 BAUDRATE : 9600
3 CMD ENVOI : IRIS CLOSE
4 CMD SORTIE: IRIS OPEN
5 VALIDATION OSM CAMÉRA>
    
```

Fig. 97

10.1.7 Menu Polarité

Il permet de configurer les paramètres suivants :

1. **Zoom:** Il permet de choisir la polarité de rotation du moteur du Zoom de l'optique.
2. **Focus:** Il permet de sélectionner la polarité de rotation du moteur du Focus de l'optique.
3. **Iris:** Il permet de sélectionner la polarité de rotation du moteur de l'Iris de l'optique.

```

POLARITÉ
-----
1>ZOOM : POSITIVE
2 FOCUS: POSITIVE
3 IRIS : POSITIVE
    
```

Fig. 98

10.1.8 Menu Mouvement

1. **Offset Pan:** La tourelle a une position de 0° définie mécaniquement. La fonction Offset Pan permet de définir une position différente de 0° à l'aide du logiciel.
2. **Contrôle Manuel:** Permet d'accéder aux sous-menus de gestion des paramètres associés aux mouvements manuels du dispositif.
3. **Preset:** Permet d'accéder aux sous-menus de modification des valeurs de Preset.
4. **Patrol:** Permet d'accéder aux sous-menus de modification des valeurs de Patrol.
5. **Autopan:** Permet d'accéder aux sous-menus de modification des valeurs de l'Autopan.
6. **Rappel Mouvements:** Permet d'accéder au sous-menu de gestion du rappel automatique des mouvements.

```

MOUVEMENT
-----
1>OFFSET PAN:      + 20.00
2  CONTROLE MANUEL  >
3  PRESET           >
4  PATROL           >
5  AUTOPAN          >
6  RAPPEL MOUVEMENTS >

```

Fig. 99

10.1.8.1 Menu Contrôle Manuel

1. **Vitesse Maximale:** Configuration de la vitesse manuelle maximale.
2. **Vitesse avec Zoom:** L'activation de ce paramètre réduit automatiquement la vitesse de Pan et Tilt en fonction du facteur de Zoom.
3. **Facteur Tilt:** Configuration du facteur de réduction de la vitesse manuelle de l'axe tilt.
4. **Limites Mouvement:** Accès au menu Limites.

```

Contrôle Manuel
-----
1>VITESSE MAX      : 20.00
2  VIT. AVEC ZOOM  :      N
3  FACTEUR TILT    :      2
4  LIMITES MOUVEMENT >

```

Fig. 100

10.1.8.2 Menu Contrôle Manuel (Limites)

Il permet de configurer les paramètres suivants :

1. **Limites Pan:** Valide les limites de Pan.
2. **Pan Début:** Configure la limite initiale de Pan.
3. **Pan Fin:** Configure la limite finale de Pan.
4. **Tilt Début:** Configure la limite initiale de Tilt.
5. **Tilt Fin:** Configure la limite finale de Tilt.

```

LIMITES
-----
1>LIMITES PAN      :      N
2 PAN DEBUT       : +  0.00
3 PAN FIN         : +  0.00
4 TILT DEBUT      : +  0.00
5 TILT FIN        : +  0.00
  
```

Fig. 101

Le menu se configure automatiquement de façon dynamique en fonction de la sélection effectuée en affichant les paramètres pouvant être modifiés.

10.1.8.3 Menu Preset

1. **Modifier Preset:** Pour accéder au menu Modifier Preset.
2. **Utilités Preset:** Pour accéder au menu Utilités Preset.

```

PRESET
-----
1>MODIFIER PRESET  >
2 UTILITES PRESET  >
  
```

Fig. 102

10.1.8.4 Menu Preset (Modifier Preset)

Il permet de configurer les paramètres suivants :

1. **Numéro:** Numéro du Preset devant être modifié.
2. **Activation:** Activation du preset.
3. **Pan:** Position de pan exprimée en degrés.
4. **Tilt:** Position de tilt exprimée en degrés.
5. **Vitesse:** Vitesse d'atteinte de la position si le Preset est rappelé par les fonctions Patrol et Autopan.
6. **Pause:** L'attente en secondes avant le début du mouvement suivant en Patrol.
7. **Texte:** Texte affiché à l'atteinte de la position de preset.
8. **Aller À Preset?:** Impose à la tourelle d'atteindre la position de Preset sélectionnée.
9. **Habiliter Mouvements:** Il permet de choisir un nouveau cadrage.

```

MODIFIER PRESET
-----
1>NR.      :      1
2 ENAB.    :      N
3 PAN      : +  0.00
4 TILT     : - 40.00
5 VIT.     :  20.00
6 PAUSE    :      5
7 TEXTE:   PRESET 001
8 ALLER À PRESET?
9 HABILITER MOUVEMENTS >
  
```

Fig. 103

Le menu permet de mémoriser directement les preset en envoyant la commande Iris Close qui active les mouvements de la tourelle.

10.1.8.5 Menu Preset (Utilités Preset)

Il permet de configurer les paramètres suivants :

1. **Vitesse Scan:** Vitesse utilisée pour atteindre la position de Preset en cas de rappel avec la commande Scan.
2. **Vitesse Par Défaut:** Vitesse par défaut des Preset. Cette valeur est utilisée par la fonction Configurer Vitesse ? pour assigner la même vitesse à tous les Preset.
3. **Pause Par Défaut:** Pause par défaut des Preset. Cette valeur est utilisée par la fonction Configurer Pause ? pour assigner la même pause à tous les Preset.
4. **Valeur Rampe:** Les temps de départ et d'arrêt. Un grand nombre de ces temps comprend une forte accélération/décélération lors des phases de départ/arrêt.
5. **Configurer Vitesse?:** Assigne à tous les Preset la vitesse par défaut.
6. **Configurer Pause?:** Assigne à tous les Preset la pause par défaut.

```

UTILITES PRESET
-----
1>VITESSE SCAN      : 20.00
2 VIT.  DEFAULT    : 10.00
3 PAUSE DEFAULT    :      3
4 VALEUR RAMPE     :    12
5 CONFIGURER VITESSE?
6 CONFIGURER PAUSE?
  
```

Fig. 104

10.1.8.6 Menu Patrol

1. **Premier Preset:** Premier preset de la séquence de Patrol.
2. **Dernier Preset:** Le dernier Preset de la séquence de Patrol.
3. **Mode Random:** Active l'exécution en mode aléatoire. La séquence est constamment recalculée.

```

PATROL
-----
1>PREMIER PRESET:    1
2 DERNIER PRESET:  250
3 MODE  RANDOM   :   N
  
```

Fig. 105

10.1.8.7 Menu Autopan

1. **Preset Aller:** Position initiale de l'Autopan.
2. **Preset Retour:** Position finale de l'Autopan.

```

AUTOPAN
-----
1>PRESET ALLER   :    1
2 PRESET RETOUR  :    2
  
```

Fig. 106



Pour connaître la vitesse d'atteinte de la position de Preset se référer au chapitre relatif. (10.1.8.4 Menu Preset (Modifier Preset), page 47).

10.1.8.8 Menu Rappel Mouvements

Il est possible de configurer le dispositif de façon à ce que, après une certaine période d'inactivité, il effectue automatiquement une fonction de mouvement choisie par l'opérateur.

1. **Type Mouvement:** Type de mouvement à rappeler (None, Home, Autopan, Patrol).
2. **Retard Mouvement:** Période d'inactivité du Joystick, en secondes.

RAPPEL MOUVEMENTS		

1>	TYPE MOUVEMENT :	NONE
2	RET. MOUVEMENT :	60

Fig. 107

10.1.9 Menu Affichages

1. **Position Actuelle:** Si différente de OFF, elle permet de sélectionner le mode d'affichage des valeurs Pan, Tilt, Zoom, Focus et Iris sur l'écran.
2. **Nom Preset:** Si différente de OFF, elle permet de sélectionner le mode d'affichage sur l'écran du texte associé à la dernière position de Preset atteinte. Il est possible de sélectionner un affichage temporel (1 s, 3 s et 5 s) ou constant (Const).
3. **ID Tourelle:** Si différente de OFF, affiche l'ID du produit.
4. **Alarmes:** Si différente de OFF, elle permet de sélectionner le mode d'affichage des textes associés à une alarme. Il est possible de sélectionner un affichage temporel (1 s, 3 s et 5 s) ou constant (Const).

5. **Commandes Reçues:** Permet de valider l'affichage des commandes sérielles reçues.
6. **Delta Horizontal:** Déplacement horizontal des textes des menus afin de permettre un meilleur centrage.
7. **Delta Vertical:** Déplacement vertical des textes des menus afin de permettre un meilleur centrage.
8. **Signal Video:** Format du signal vidéo.

AFFICHAGES		

1	POSITION ACT.	: ON
2	NOM PRESET	: 5 S
3	ID TOURELLE	: ON
4	ALARMES	: ON
5	COMMANDES RECUES:	ON
6	DELTA HORIZONTAL:	35
7	DELTA VERTICAL	: 10
8	SIGNAL VIDEO	: PAL

Fig. 108

Le menu se configure tout seul dynamiquement selon le modèle de tourelle.

10.1.10 Menu I/O Numériques-Options

1. **Alarmes:** Accès au menu Alarmes.
2. **Système De Lavage:** Accès au menu Système de Lavage.
3. **Communications:** Accès au menu Communications.

I/O NUMERIQUES-OPTIONS		

1>	ALARMES	>
2	SYSTEME DE LAVAGE	>
3	COMMUNICATIONS	>

Fig. 109

10.1.10.1 Menu Alarmes

- 01-04. **Alarmes 1-4:** Accès aux menus dans lesquels il est possible de modifier les paramètres des Alarmes de 1 à 4.
05. **Etat des Alarmes:** Accès au menu État des Alarmes.

```

ALARMES
-----
1>ALARME 1      >
2  ALARME 2      >
3  ALARME 3      >
4  ALARME 4      >
5  ETAT ALARMES  >
  
```

Fig. 110

Le menu se configure tout seul dynamiquement selon le modèle de tourelle.

À l'intérieur des menus des alarmes simples il est possible de configurer les valeurs suivantes :

1. **Type:** Type de contact, normalement clos (N.C.) ou normalement ouvert (N.O.)
2. **Action:** Le type d'action que la tourelle effectue quand l'alarme s'actionne (Off, Msg, PTZ Stop, Wiper, Washer, Scan, Patrol, Autopan, Relay, Ir Filt). Le paramètre OFF (éteint) désactive l'alarme.
3. **Numéro:** La présélection à atteindre quand le type d'action de l'alarme est Scan.
4. **Texte:** Le message est affiché lorsque l'alarme est active.

```

ALARME 1
-----
1>TYPE :      N.C.
2  ACT. :      SCAN
3  NR.  :      1
4  TEXTE: ALARM 1
  
```

Fig. 111

Le menu se configure automatiquement de façon dynamique en fonction de la sélection effectuée en affichant les paramètres pouvant être modifiés.

Le menu État des Alarmes affiche l'état des entrées des alarmes (Closed, Open).

```

ETAT ALARMES
-----
ALARME 1      CLOSED
ALARM 2       OPEN
ALLARME 3     CLOSED
ALLARME 4     CLOSED
  
```

Fig. 112

10.1.10.2 Menu des Communications

1. **ACK Série!** Il configure la tourelle pour habilitier / exclure l'envoi d'une réponse avec ACK aux commandes sérielles.
2. **ACK PELCO D Standard:** Il configure l'ACK de réponse de la commande PELCO D. Le menu est invisible si le protocole de communication programmé par les DIP switch n'est pas PELCO D ou si l'ACK de réponse n'est pas habilité (ACK SERIALE = FALSE). Si la rubrique du menu est habilitée, l'ACK de réponse est de type standard (somme de contrôle liée au message original). Si la rubrique du menu est exclue, la somme de contrôle est calculée seulement sur ce même paquet d'ACK.

```

COMMUNICATIONS
-----
1 ACK SERIEL      : O
2 DEFAULT PELCOD ACK : N
  
```

Fig. 113

10.1.10.3 Menu Système de lavage

L'unité offre la possibilité d'utiliser un essuie-glace et d'actionner une pompe pour le nettoyage de la glace.

Pour configurer le système de lavage, positionner l'objectif de la caméra devant la buse du système de lavage.

Sauvegarder une présélection (XY) pour cette position, qui sera rappelée par la tourelle lors de la validation de la fonction Washer.

Configurer les paramètres suivants:

1. **Valider:** Activation de la fonction Washer.
2. **Preset Buse:** Insérer le n° de la présélection (XY) correspondant à la buse.
3. **Retard Essuie-glace On:** Sélectionner l'intervalle de temps qu'il y a entre l'activation de la pompe et celle de l'essuie-glace.
4. **Durée De Lavage:** Choisir la durée de balayage.
5. **Retard Essuie-glace Off:** Choisir la durée de balayage sans eau.

```

SYSTEME DE LAVAGE
-----
1>ACTIVE           : N
2 PRESET BUSE     : 1
3 RETARD ESSUIE ON : 5
4 DUREE LAVAGES   : 10
5 RETARD ESSUIE OFF : 5
  
```

Fig. 114

10.1.11 Menu Par Défaut

1. **Effacer Setup?:** Rétablissement de tous les paramètres à l'exception des preset.
2. **Effacer Preset?:** Élimine tous les preset mémorisés précédemment.

```

DEFAULT
-----
1>EFFACER SETUP?
2 EFFACER PRESET?
  
```

Fig. 115



Les opérations susmentionnées entraînent la perte de toutes les données mémorisées précédemment (ex.: Preset, Patrol, Autopan, Home...).

10.1.12 Menu Infos

Permet de vérifier la configuration du dispositif et la version de micrologiciel installée.

```

REMARQUE
-----
Device ID: 00001
Type      : Rs485 only Rx
Baud Rate: 38400-8N1
Protocol  : MACRO
Net Board: Fw6.02 Hw01
Mpp Board: Fw6.02 Hw00
Config.   : 001
P.C.      : UPT1SVSA000E
S.N.      : 000000000000
Upgrade   : NET BOARD
  
```

Fig. 116

11 Accessoires

i Pour de plus amples informations sur la configuration et l'utilisation, consulter le manuel de l'accessoire correspondant.

11.1 Système de lavage

La tourelle peut être équipée d'une pompe extérieure qui fournit de l'eau pour le nettoyage de la vitre.

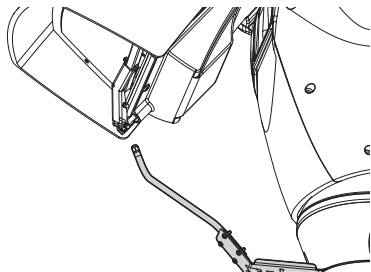

Fig. 117

11.1.1 Branchement du système de lavage

! ATTENTION! L'installation est du type TNV-1. Ne pas la connecter à des circuits SELV.

! ATTENTION! Pour réduire les risques d'incendie, utiliser uniquement des câbles certifiés UL Listed ou CSA de sections égales ou supérieures à 0.14mm² (26AWG).

! Tous les câbles de signalisation doivent également être regroupés avec un collier.

BRANCHEMENT DU SYSTÈME DE LAVAGE	
Bornes	Description
AL1-COM AL1-AGND	Entrée de l'alarme. Les systèmes de lavage pourvus de capteur de niveau signalent l'absence de liquide à l'intérieur du réservoir.
O1-C1	Contact sec pour activation du système de lavage.

Tab. 17

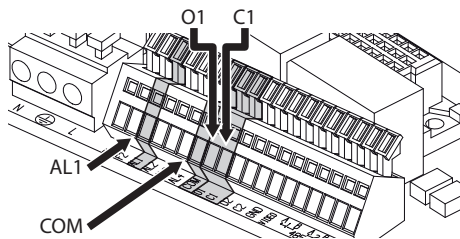

Fig. 118 Version standard.

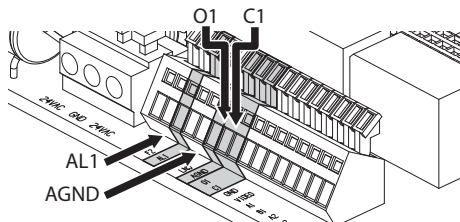

Fig. 119 Version avec projecteurs à LED.

i Pour d'autres renseignements se référer à le chapitre relatif (10.1.10.3 Menu Système de lavage, page 51).

11.2 Support fixation murale

Support mural avec passage interne des câbles.

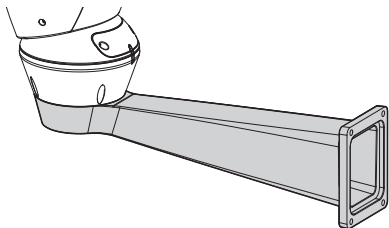

Fig. 120

11.3 Support fixation sol

Support de fixation au sol avec passage interne des câbles.

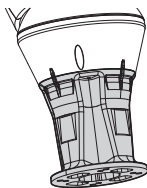

Fig. 121

11.4 Alimentateur avec contrôle des projecteurs.

Boîte étanche avec alimentateur et contrôle des projecteurs.

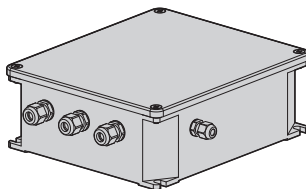

Fig. 122 Version du boîtier standard.

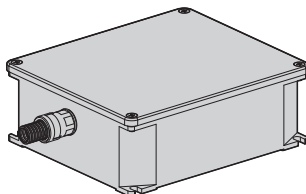

Fig. 123 Version du boîtier certifié UL.



Pour d'autres renseignements se référer à le chapitre relatif (8.5.3 Branchement des entrées d'alarme, de l'interrupteur crépusculaire et des relais, page 26).

12 Instructions de fonctionnement courant

12.1 Affichage de l'état de la tourelle

Durant le fonctionnement normal, au choix de l'utilisateur, la tourelle affiche sur le moniteur les données organisées selon les illustrations. L'affichage peut être validé ou exclu (10.1.9 Menu Affichages, page 49).

ID 1: Adresse du récepteur;

ZONE 1: Nom de l'aire dans laquelle on se trouve;

MASK 1: Nom du masque affiché;

ALARM 1: Texte de la dernière alarme validée;

Preset 001 go to: Commandes reçues par sérielle;

E1: PATROL CONFIGURATION: Affichage des erreurs détectées durant le fonctionnement du système.;

PAN/TILT/Z/F/I: Position actuelle de PAN, TILT, ZOOM, FOCUS et IRIS;

PRESET 001: Nom de la présélection choisie validée.

```

ID 1

ZONE 1
MASK 1
ALARM1
Preset 001 go to

E1: PATROL CONFIGURATION
PAN : +000.00
TILT: +000.00
Z:000.0 F:000.0 I:000.0
PRESET 001
  
```

Fig. 124

12.2 Enregistrement d'un Preset

A l'aide du dispositif de contrôle utilisé, il est possible de sauvegarder la position actuelle (pour de plus amples informations, se référer au manuel du dispositif utilisé).

12.3 Rappel d'une position de Preset (Scan)

Avec un dispositif de contrôle, il est possible de rappeler une position de Preset précédemment sauvegardée (pour de plus amples informations, se référer au manuel du dispositif utilisé).

12.4 Rappel de la position de Home

Avec un dispositif de contrôle, il est possible de rappeler une position de Home (Scan n.1) précédemment sauvegardée (pour plus d'informations, se référer au manuel du dispositif de contrôle utilisé).

12.5 Activation du Patrol

La fonction Patrol rappelle de façon séquentielle les Preset mémorisés.

Pour activer/désactiver la fonction se référer au chapitre relatif du manuel du dispositif de contrôle utilisé. (12.11 Commandes spéciales, page 56).

Pour désactiver la fonction déplacer le joystick ou bien rappeler un type de mouvement différent.

Pour configurer cette fonction se référer au chapitre relatif. (10.1.8.6 Menu Patrol, page 48).

12.6 Activation de l'Autopan

La fonction Autopan rappelle de façon continue les 2 Preset mémorisés.

Pour activer/désactiver la fonction se référer au chapitre relatif du manuel du dispositif de contrôle utilisé. (12.11 Commandes spéciales, page 56).

Pour désactiver la fonction déplacer le joystick ou bien rappeler un type de mouvement différent.

Pour configurer cette fonction se référer au chapitre relatif. (10.1.8.7 Menu Autopan, page 48).

12.7 Validation de l'essuie-glace (Wiper)



Ne pas utiliser l'essuie-glace lorsque la température extérieure est inférieure à 0°C ou en cas de givre.

Pour activer/désactiver la fonction se référer au chapitre relatif du manuel du dispositif de contrôle utilisé. (12.11 Commandes spéciales, page 56).



L'essuie-glace est exclu de façon automatique si on le laisse allumé.

12.8 Activation du système de lavage (Washer)

Lorsque l'on envoie la commande, la tourelle se positionne avec la vitre devant la buse. La pompe et l'essuie-glace sont validés pendant une durée déterminée. À la fin de la procédure la tourelle revient dans sa position initiale.

Pour activer/désactiver la fonction se référer au chapitre relatif du manuel du dispositif de contrôle utilisé. (12.11 Commandes spéciales, page 56).

Pour activer les configurations spéciales se référer au chapitre relatif. (12.12 Configuration spéciales, page 57).

Pour les modèles avec système de lavage équipés de capteur de niveau, peut en outre visualiser un message sur la vidéo quand le niveau du liquide dans le réservoir est insuffisant (seulement si l'on utilise une pompe à grande hauteur d'élévation).

12.9 Activation du projecteur à LED

Si le dispositif n'est pas pourvu d'interrupteur crépusculaire, il est possible d'activer/désactiver le projecteur à LED au moyen de la commande spécialement prévue. (12.11 Commandes spéciales, page 56).

12.10 Reboot du dispositif

Au moyen d'un dispositif de contrôle il est possible d'envoyer la commande de réinitialisation de l'unité (pour plus d'informations, se référer au manuel du dispositif de contrôle utilisé).

Pour d'autres renseignements se référer à la chapitre relatif (12.11 Commandes spéciales, page 56).

12.11 Commandes spéciales

COMMANDES SPÉCIALES

Action	Commande					
	Protocole					
	AMERICAN DYNAMICS	ERNITEC	PANASONIC	PELCO D	VIDEOTEC MACRO	VISTA
Wiper Start	Sauver Preset 85	Sauver Preset 85	Sauver Preset 85	Sauver Preset 85	Sauver Preset 85	Sauver Preset 85
	Aux 3 ON	Aux 3 ON	Sauver Preset 54	Aux 3 ON	Aux 3 ON	Aux 3 ON
					Wip+	
Wiper Stop	Sauver Preset 86	Sauver Preset 86	Sauver Preset 86	Sauver Preset 86	Sauver Preset 86	Sauver Preset 86
	Aux 3 OFF	Aux 3 OFF	Sauver Preset 55	Aux 3 OFF	Aux 3 OFF	Aux 3 OFF
					Wip-	
Washer Start	Sauver Preset 87	Sauver Preset 87	Sauver Preset 87	Sauver Preset 87	Sauver Preset 87	Sauver Preset 87
	Aux 4 ON	Aux 4 ON	Sauver Preset 56	Aux 4 ON	Aux 4 ON	Aux 4 ON
					Was+	
Modalité Nocturne On	Sauver Preset 88	Sauver Preset 88	Sauver Preset 88	Sauver Preset 88	Sauver Preset 88	Sauver Preset 88
			Sauver Preset 57			
Modalité Nocturne Off	Sauver Preset 89	Sauver Preset 89	Sauver Preset 89	Sauver Preset 89	Sauver Preset 89	Sauver Preset 89
			Sauver Preset 58			
Patrol Stop	Sauver Preset 92	Sauver Preset 92	Sauver Preset 92	Sauver Preset 92	Sauver Preset 92	Sauver Preset 92
	Joystick	Joystick	Joystick	Joystick	Joystick	Joystick
			Sauver Preset 59		Pat-	
Patrol Start	Sauver Preset 93	Sauver Preset 93	Sauver Preset 93	Sauver Preset 93	Sauver Preset 93	Sauver Preset 93
	Activer pattern 1	Activer patrol	Sauver Preset 60	Pattern	Pat+	Activer Patrol
Reboot du dispositif	Sauver Preset 94	Sauver Preset 94	Sauver Preset 94	Sauver Preset 94	Sauver Preset 94	Sauver Preset 94
	Faster+ Zoom out+ Focus far+ Iris open		Sauver Preset 61		Ini+	
Validation OSM	Sauver Preset 95	Sauver Preset 95	Sauver Preset 95	Sauver Preset 95	Sauver Preset 95	Sauver Preset 95
	Iris open+ Focus+ Zoom out		Sauver Preset 46		Men+	
Autopan Stop	Sauver Preset 96	Sauver Preset 96	Sauver Preset 96	Sauver Preset 96	Sauver Preset 96	Sauver Preset 96
	Joystick	Joystick	Joystick	Joystick	Joystick	Joystick
			Sauver Preset 62		Apa-	
Autopan Start	Sauver Preset 99	Sauver Preset 99	Sauver Preset 99	Sauver Preset 99	Sauver Preset 99	Sauver Preset 99
	Activer Pattern 2	Activer Autopan	Sauver Preset 63	Pattern 1	Apa+	Activer Autopan

Tab. 18

12.12 Configuration spéciales

CONFIGURATION SPÉCIALES					
Configuration	Protocole				
	AMERICAN DYNAMICS	PANASONIC	PELCO D	VIDEOTEC MACRO	VISTA
Washer Configuration 1 (lavage court)	Sauver Preset 72	Sauver Preset 72	Sauver Preset 72	Sauver Preset 72	Sauver Preset 72
Washer Configuration 2 (lavage long)	Sauver Preset 73	Sauver Preset 73	Sauver Preset 73	Sauver Preset 73	Sauver Preset 73

Tab. 19

13 Entretien



L'entretien doit être **uniquement effectué par un personnel qualifié en matière de circuits électriques.**

13.1 Remplacement des fusibles



Il faut effectuer l'entretien en **absence d'alimentation et lorsque le dispositif de sectionnement ouvert.**

En cas de nécessité remplacer les fusibles illustrés sur la figure (8.3 Description de la carte de connexion, page 21).

REPLACEMENT DES FUSIBLES		
Tension	Fusible F1	Fusible F2
24Vac, 50/60Hz	T 4A L 250V 5x20	T 6.3A H 250V 5x20 (version standard)
		T 8A H 250V 5x20 (version avec projecteurs à LED)
120Vac, 50/60Hz	T 4A L 250V 5x20	T 4A H 250V 5x20
230Vac, 50/60Hz	T 4A L 250V 5x20	T 2A H 250V 5x20

Tab. 20

14 Nettoyage

14.1 Entretien de la vitre et des parties en plastique



On doit éviter alcool éthylique, solvants, hydrocarbures hydro-génés, acides forts et alcali. L'emploi de ce type de produits abîme d'une façon irréparable la surface traitée.

Il est conseillé d'utiliser un chiffon souple avec des savons neutres dilués avec de l'eau ou des produits spécifiques pour le nettoyage des verres des lunettes.

14.2 Nettoyage de la fenêtre au germanium



Nettoyer la fenêtre en ayant soin de ne pas rayer ni érafler l'enduit protecteur de carbone externe. L'endommagement du revêtement risque de compromettre la transparence à l'infrarouge de la surface.

Le nettoyage doit être fait avec du savon neutre dilué avec de l'eau.

15 Élimination des déchets



Ce symbole et le système de recyclage ne sont appliqués que dans les pays UE et non dans les autres pays du monde.

Votre produit est conçu et fabriqué avec des matériels et des composants de qualité supérieure qui peuvent être recyclés et réutilisés.

Ce symbole signifie que les équipements électriques et électroniques en fin de vie doivent être éliminés séparément des ordures ménagères.

Nous vous prions donc de confier cet équipement à votre Centre local de collecte ou Recyclage.

Dans l'Union Européenne, il existe des systèmes sélectifs de collecte pour les produits électriques et électroniques usagés.

16 Dépannage

Demander l'intervention d'un personnel qualifié dans les cas suivants:

- L'unité est endommagée à la suite d'une chute;
- Les performances de l'unité ont baissé.
- L'unité ne fonctionne pas correctement après avoir respecté toutes les indications de ce manuel.

PROBLÈME	Le produit ne s'allume pas.
CAUSE	Câblage incorrect, rupture des fusibles.
SOLUTION	Vérifier les connexions. Vérifié la continuité des fusibles et les remplacer avec les modèles indiqués en cas de panne.

PROBLÈME	Dans des conditions particulières de zoom, une interférence se produit entre le caisson ou le toit et l'image filmée (version avec système optique motorisé uniquement).
CAUSE	Position de la caméra ou de l'optique trop en retrait par rapport à la vitre.
SOLUTION	Régler la position de la caméra et de l'optique.

PROBLÈME	L'écran n'affiche pas l'image filmée mais il est bleu avec l'indication : No Video Signal!!!
CAUSE	Câblage de la caméra erroné ou caméra en panne.
SOLUTION	Vérifier les connexions.

PROBLÈME	Durant l'allumage la tourelle reste bloquée et affiche une page-écran du type:
-----------------	---

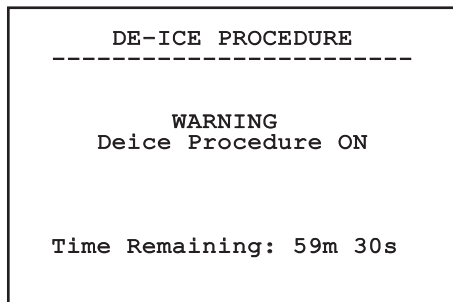

CAUSE	La température ambiante est très basse.
SOLUTION	Attendre la fin de la procédure de préchauffage. Si la température ambiante est trop basse, la tourelle reste bloquée en affichant la page-écran suivante :

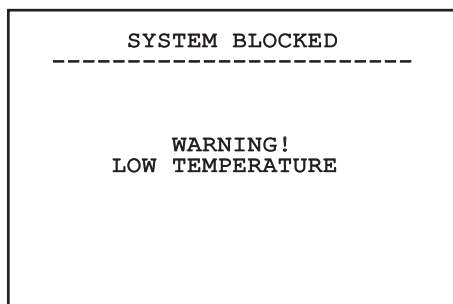

PROBLÈME L'écran n'affiche pas l'image filmée mais l'écran suivant :

REMARQUE

```

-----
Device ID: 00001
Type      : Rs485 only Rx
Baud Rate: 19200-8N1
Protocol  : PELCO-D
Net Board: Fw05.01 Hw00
Mpp Board: Fw05.01 Hw00
Config.   : 001
P.C.     : UPT1SMSA005C
S.N.     : 00000000000000
Upgrade  : NET BOARD
-----

```

CAUSE Dip switch de programmation activé.

SOLUTION Éteindre la tourelle. Baisser le levier du dip-switch de mise à jour du firmware (8.14.2 Configuration du DIP1, page 34). Rallumer le dispositif.

PROBLÈME **Erreur E1:PATROL CONFIGURATION.**

CAUSE Les Preset n'ont pas été enregistrés.
Les Preset n'ont pas été activés.

SOLUTION Sauvegarder deux ou plusieurs preset (12.2 Enregistrement d'un Preset, page 54). Mettre à jour le menu de configuration Patrol (10.1.8.6 Menu Patrol, page 48).
Activer les preset (10.1.8.4 Menu Preset (Modifier Preset), page 47).

PROBLÈME **Erreur E2:AUTOPAN CONFIGURATION.**

CAUSE Les deux Preset utilisés comme limites n'ont pas été enregistrés.

Les deux Preset utilisés comme limites n'ont pas été activés.

SOLUTION Sauvegarder les deux preset (12.2 Enregistrement d'un Preset, page 54). Mettre à jour le menu de configuration de l'autopan (10.1.8.7 Menu Autopan, page 48).
Activer les preset (10.1.8.4 Menu Preset (Modifier Preset), page 47).

PROBLÈME **Erreur E3:WASHER DISABLED ou erreur E4:WASHER PRST DISABLED.**

CAUSE Système de lavage non activé.

SOLUTION Activer le système de lavage (10.1.10.3 Menu Système de lavage, page 51).

PROBLÈME **Erreur PRESET XXX NOT ENABLED.**

CAUSE Rappel d'un preset non enregistré.
Rappel d'un preset non activé.

SOLUTION Sauvegarder la présélection à l'aide de la commande prévue à cet effet (12.2 Enregistrement d'un Preset, page 54).
Activer le preset (10.1.8.4 Menu Preset (Modifier Preset), page 47).

17 Données techniques

17.1 Généralités

Fabriqué en fonte d'aluminium et en technopolymère

Vernissage avec poudres époxypolyester, couleur RAL9002

Caisson positionné en partie supérieure (OTT)

Fins de course électroniques

Aucun jeu mécanique

Poids maximum caméra+optique: 7.6kg

Capteurs optiques pour positionnement absolu

Nombre maximum de presets: 250 (VIDEOTEC MACRO)

Affichage alphanumérique de 15 caractères pour titrage zone et preset

Programmation par OSM

Jusqu'à 255 unités adressables par DIP-switch

17.2 Mécanique

Presse-étoupes: 3xM16

Rotation horizontale: continue

Rotation verticale: de +45° jusqu'à -20°

Vitesse horizontale (variable): de 0.02°/s jusqu'à 20°/s

Vitesse verticale (variable): de 0.02°/s jusqu'à 20°/s

Surface intérieure utile: Voir dessins

Transmission par courroie dentée de haute précision

Précision du rappel des positions de preset: 0.02°

Poids net: 30kg

17.3 Fenêtres pour caisson

Fenêtre en verre

- Dimensions: 112mmx95mm

Fenêtre au germanium

- Diamètre: 85mm (externe), 70mm (diamètre utile)
- Épaisseur: 2mm
- Traitement externe anti-rayures: Hard Carbon Coating (DLC)
- Traitement intérieur anti-reflets

Réponse spectrale: de 7.5µm jusqu'à 14µm

Transmittance moyenne (de 7.5µm jusqu'à 11.5µm): 94%

Transmittance moyenne (de 11.5µm jusqu'à 14µm): 90%

Transmittance de la fenêtre en germanium

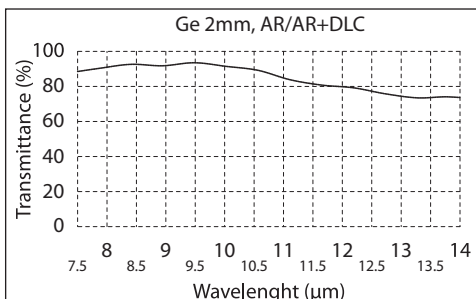

Fig. 125

17.4 Électrique

Tension d'alimentation/Courant absorbé:

- 230Vac, 0.4A, 50/60Hz
- 24Vac, 4A (8A pour projecteurs à LED), 50/60Hz
- 120Vac, 0.8A, 50/60Hz

Puissance absorbée:

- 100W
- 150-190W max pour projecteurs à LED en 24Vac
- 24W, tourelle à l'arrêt, chauffage éteint

Alimentation de la camera: 12Vdc, 800mA

Section des câbles d'entrée:

- 0.75mm² (18AWG), 120Vac ou 230Vac
- 1.5mm² (16AWG), 24Vac

Section des câbles de signal: de 0.14mm² (26AWG) jusqu'à 0.5mm² (20AWG)

17.5 Vidéo

Ligne vidéo: câble coaxial (1Vpp, 750hm)

17.6 Communications

Interface RS-232 pour la mise à jour du firmware

2 ports RS-485 pour la configuration en cascade

17.7 Protocoles

Configuration des paramètres des protocoles de télémetrie avec DIP-switch

Protocoles supportés:

- AMERICAN DYNAMICS
- PANASONIC
- PELCO D
- VIDEOTEC MACRO
- VISTA

17.8 Interface I/O

Entrées d'alarme:

- 4 (version standard)
- 2 (version avec projecteurs à LED)
- Tension de commande: De 10Vdc jusqu'à 35Vdc

Contacts secs:

- 2 (version standard)
- 1 (version avec projecteurs à LED)
- Tension applicable: 50Vdc max ou 30Vac@1A

17.9 Optiques

Alimentation: De 6Vdc a 15Vdc, 200mA max

Contrôle: À inversion de polarité et optiques à fil commun

17.10 Environnement

Intérieur/Extérieur

Température de fonctionnement (avec chauffage): De -10° jusqu'à +60°C

17.11 Certifications

Sécurité électrique (CE): EN60950-1

Compatibilité électromagnétique (CE): EN50130-4, EN55022 (Classe B), FCC Part 15 (Classe B)

Installation à l'extérieur (CE): EN60950-22

Degré de protection IP: EN60529 (IP66)

Résistant au brume saline: EN50130-5, EN60068-2-52

Certification EAC

18 Dessins techniques



Les dimensions des dessins sont exprimées en millimètres.

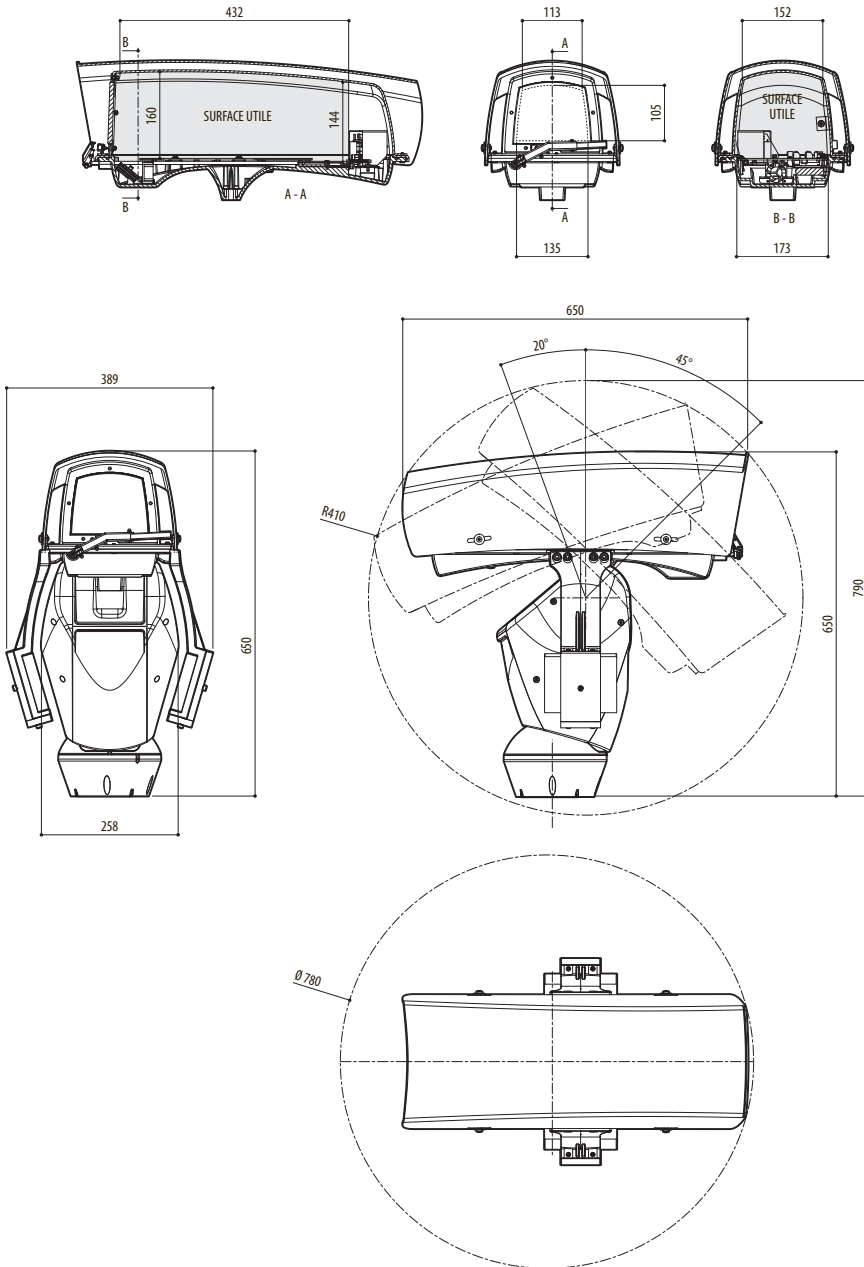

Fig. 126 ULISSE MAXI, version standard.

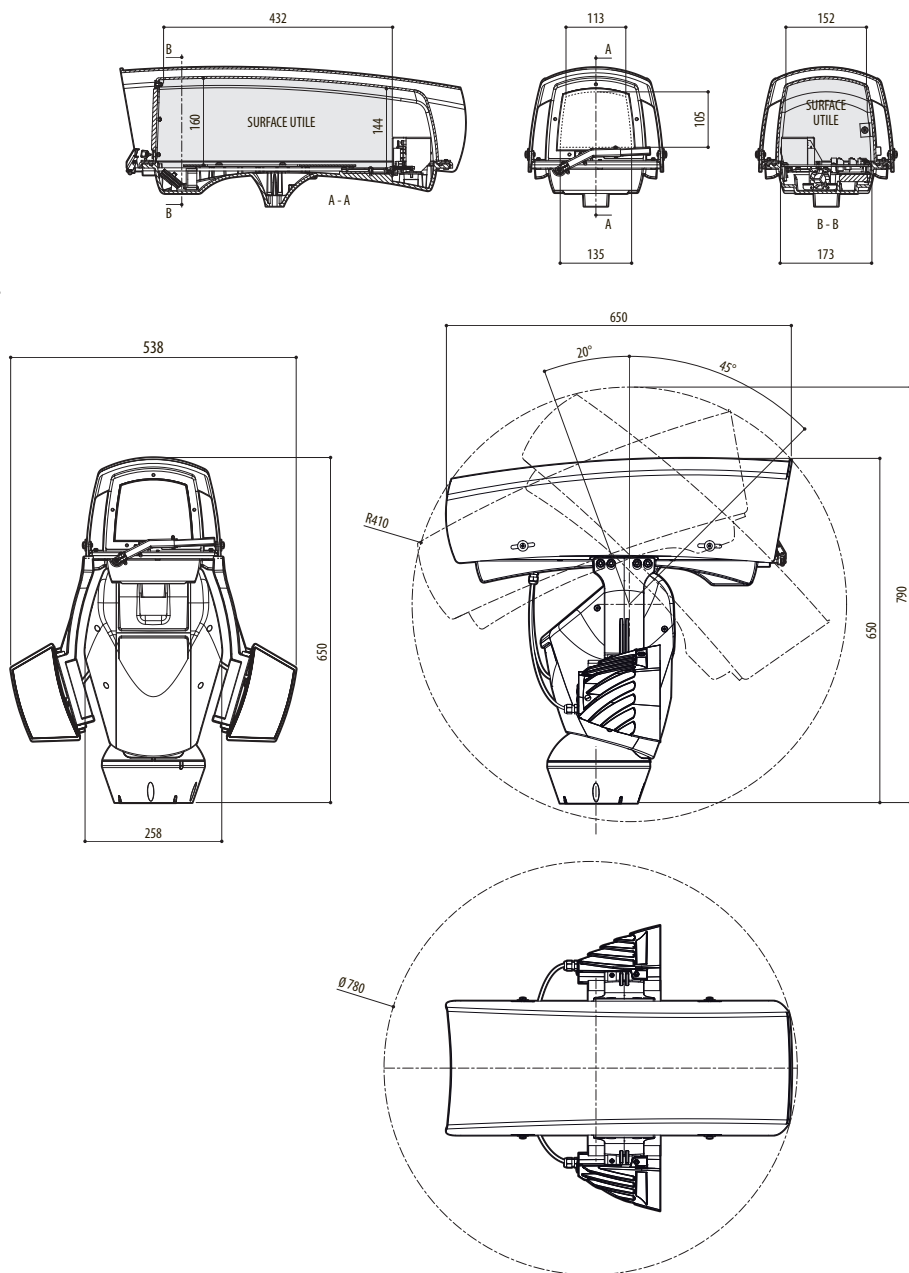

Fig. 127 ULISSE MAXI, version avec prédisposition pour le montage des deux projecteurs à LED.

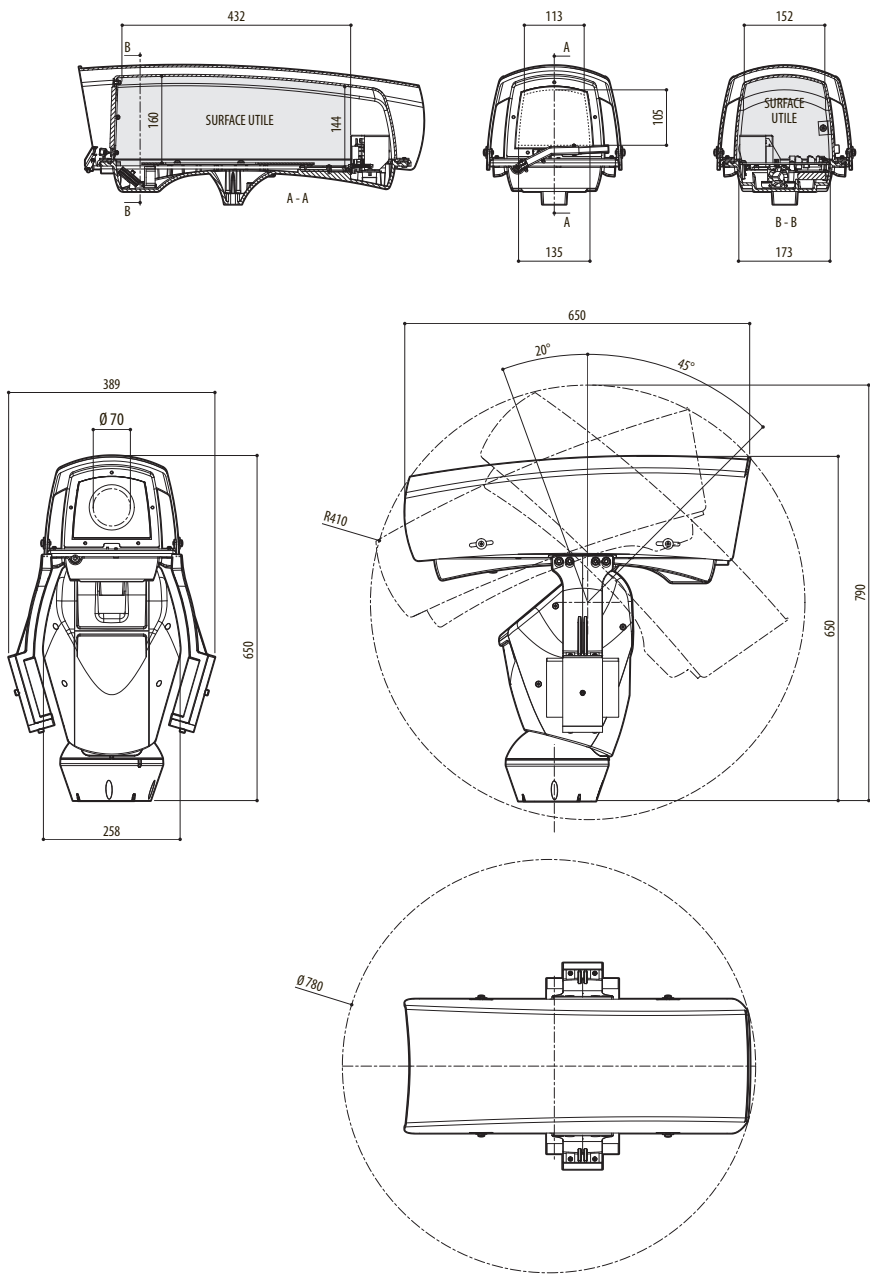

Fig. 128 ULISSE MAXI, version pour caméras thermiques.

A Annexe - Tableau des adresses



Le levier du switch vers le haut représente la valeur 1 (ON). Le levier du dip-switch vers le bas représente la valeur 0 (OFF).

Ci-après, on reporte toutes les combinaisons possibles.

CONFIGURATION DE L'ADRESSE (DIP 3)								
SW 8	SW 7	SW 6	SW 5	SW 4	SW 3	SW 2	SW 1	Adresse
OFF	OFF	OFF	OFF	OFF	OFF	OFF	OFF	Adresse non valide
OFF	OFF	OFF	OFF	OFF	OFF	OFF	ON	Adresse 1
OFF	OFF	OFF	OFF	OFF	OFF	ON	OFF	Adresse 2
OFF	OFF	OFF	OFF	OFF	OFF	ON	ON	Adresse 3
OFF	OFF	OFF	OFF	OFF	ON	OFF	OFF	Adresse 4
OFF	OFF	OFF	OFF	OFF	ON	OFF	ON	Adresse 5
OFF	OFF	OFF	OFF	OFF	ON	ON	OFF	Adresse 6
OFF	OFF	OFF	OFF	OFF	ON	ON	ON	Adresse 7
OFF	OFF	OFF	OFF	ON	OFF	OFF	OFF	Adresse 8
OFF	OFF	OFF	OFF	ON	OFF	OFF	ON	Adresse 9
OFF	OFF	OFF	OFF	ON	OFF	ON	OFF	Adresse 10
OFF	OFF	OFF	OFF	ON	ON	ON	ON	Adresse 11
OFF	OFF	OFF	OFF	ON	ON	OFF	OFF	Adresse 12
OFF	OFF	OFF	OFF	ON	ON	OFF	ON	Adresse 13
OFF	OFF	OFF	OFF	ON	ON	ON	OFF	Adresse 14
OFF	OFF	OFF	OFF	ON	ON	ON	ON	Adresse 15
OFF	OFF	OFF	ON	OFF	OFF	OFF	OFF	Adresse 16
OFF	OFF	OFF	ON	OFF	OFF	OFF	ON	Adresse 17
OFF	OFF	OFF	ON	OFF	OFF	ON	OFF	Adresse 18
OFF	OFF	OFF	ON	OFF	OFF	ON	ON	Adresse 19
OFF	OFF	OFF	ON	OFF	ON	OFF	OFF	Adresse 20
OFF	OFF	OFF	ON	OFF	ON	OFF	ON	Adresse 21
OFF	OFF	OFF	ON	OFF	ON	ON	OFF	Adresse 22
OFF	OFF	OFF	ON	OFF	ON	ON	ON	Adresse 23
OFF	OFF	OFF	ON	ON	OFF	OFF	OFF	Adresse 24
OFF	OFF	OFF	ON	ON	OFF	OFF	ON	Adresse 25
OFF	OFF	OFF	ON	ON	OFF	ON	OFF	Adresse 26
OFF	OFF	OFF	ON	ON	OFF	ON	ON	Adresse 27
OFF	OFF	OFF	ON	ON	ON	OFF	OFF	Adresse 28
OFF	OFF	OFF	ON	ON	ON	OFF	ON	Adresse 29
OFF	OFF	OFF	ON	ON	ON	ON	OFF	Adresse 30
OFF	OFF	OFF	ON	ON	ON	ON	ON	Adresse 31
OFF	OFF	ON	OFF	OFF	OFF	OFF	OFF	Adresse 32
OFF	OFF	ON	OFF	OFF	OFF	OFF	ON	Adresse 33
OFF	OFF	ON	OFF	OFF	OFF	ON	OFF	Adresse 34
OFF	OFF	ON	OFF	OFF	OFF	ON	ON	Adresse 35
OFF	OFF	ON	OFF	OFF	ON	OFF	OFF	Adresse 36
OFF	OFF	ON	OFF	OFF	ON	OFF	ON	Adresse 37
OFF	OFF	ON	OFF	OFF	ON	ON	OFF	Adresse 38

CONFIGURATION DE L'ADRESSE (DIP 3)								
SW 8	SW 7	SW 6	SW 5	SW 4	SW 3	SW 2	SW 1	Adresse
OFF	OFF	ON	OFF	OFF	ON	ON	ON	Adresse 39
OFF	OFF	ON	OFF	ON	OFF	OFF	OFF	Adresse 40
OFF	OFF	ON	OFF	ON	OFF	OFF	ON	Adresse 41
OFF	OFF	ON	OFF	ON	OFF	ON	OFF	Adresse 42
OFF	OFF	ON	OFF	ON	OFF	ON	ON	Adresse 43
OFF	OFF	ON	OFF	ON	ON	OFF	OFF	Adresse 44
OFF	OFF	ON	OFF	ON	ON	OFF	ON	Adresse 45
OFF	OFF	ON	OFF	ON	ON	ON	OFF	Adresse 46
OFF	OFF	ON	OFF	ON	ON	ON	ON	Adresse 47
OFF	OFF	ON	ON	OFF	OFF	OFF	OFF	Adresse 48
OFF	OFF	ON	ON	OFF	OFF	OFF	ON	Adresse 49
OFF	OFF	ON	ON	OFF	OFF	ON	OFF	Adresse 50
OFF	OFF	ON	ON	OFF	OFF	ON	ON	Adresse 51
OFF	OFF	ON	ON	OFF	ON	OFF	OFF	Adresse 52
OFF	OFF	ON	ON	OFF	ON	OFF	ON	Adresse 53
OFF	OFF	ON	ON	OFF	ON	ON	OFF	Adresse 54
OFF	OFF	ON	ON	OFF	ON	ON	ON	Adresse 55
OFF	OFF	ON	ON	ON	OFF	OFF	OFF	Adresse 56
OFF	OFF	ON	ON	ON	OFF	OFF	ON	Adresse 57
OFF	OFF	ON	ON	ON	OFF	ON	OFF	Adresse 58
OFF	OFF	ON	ON	ON	OFF	ON	ON	Adresse 59
OFF	OFF	ON	ON	ON	ON	OFF	OFF	Adresse 60
OFF	OFF	ON	ON	ON	ON	OFF	ON	Adresse 61
OFF	OFF	ON	ON	ON	ON	ON	OFF	Adresse 62
OFF	OFF	ON	ON	ON	ON	ON	ON	Adresse 63
OFF	ON	OFF	OFF	OFF	OFF	OFF	OFF	Adresse 64
OFF	ON	OFF	OFF	OFF	OFF	OFF	ON	Adresse 65
OFF	ON	OFF	OFF	OFF	OFF	ON	OFF	Adresse 66
OFF	ON	OFF	OFF	OFF	OFF	ON	ON	Adresse 67
OFF	ON	OFF	OFF	OFF	ON	OFF	OFF	Adresse 68
OFF	ON	OFF	OFF	OFF	ON	OFF	ON	Adresse 69
OFF	ON	OFF	OFF	OFF	ON	ON	OFF	Adresse 70
OFF	ON	OFF	OFF	OFF	ON	ON	ON	Adresse 71
OFF	ON	OFF	OFF	ON	OFF	OFF	OFF	Adresse 72
OFF	ON	OFF	OFF	ON	OFF	OFF	ON	Adresse 73
OFF	ON	OFF	OFF	ON	OFF	ON	OFF	Adresse 74
OFF	ON	OFF	OFF	ON	OFF	ON	ON	Adresse 75
OFF	ON	OFF	OFF	ON	ON	OFF	OFF	Adresse 76
OFF	ON	OFF	OFF	ON	ON	OFF	ON	Adresse 77
OFF	ON	OFF	OFF	ON	ON	ON	OFF	Adresse 78
OFF	ON	OFF	OFF	ON	ON	ON	ON	Adresse 79
OFF	ON	OFF	ON	OFF	OFF	OFF	OFF	Adresse 80
OFF	ON	OFF	ON	OFF	OFF	OFF	ON	Adresse 81
OFF	ON	OFF	ON	OFF	OFF	ON	OFF	Adresse 82

CONFIGURATION DE L'ADRESSE (DIP 3)								
SW 8	SW 7	SW 6	SW 5	SW 4	SW 3	SW 2	SW 1	Adresse
OFF	ON	OFF	ON	OFF	OFF	ON	ON	Adresse 83
OFF	ON	OFF	ON	OFF	ON	OFF	OFF	Adresse 84
OFF	ON	OFF	ON	OFF	ON	OFF	ON	Adresse 85
OFF	ON	OFF	ON	OFF	ON	ON	OFF	Adresse 86
OFF	ON	OFF	ON	OFF	ON	ON	ON	Adresse 87
OFF	ON	OFF	ON	ON	OFF	OFF	OFF	Adresse 88
OFF	ON	OFF	ON	ON	OFF	OFF	ON	Adresse 89
OFF	ON	OFF	ON	ON	OFF	ON	OFF	Adresse 90
OFF	ON	OFF	ON	ON	OFF	ON	ON	Adresse 91
OFF	ON	OFF	ON	ON	ON	OFF	OFF	Adresse 92
OFF	ON	OFF	ON	ON	ON	OFF	ON	Adresse 93
OFF	ON	OFF	ON	ON	ON	ON	OFF	Adresse 94
OFF	ON	OFF	ON	ON	ON	ON	ON	Adresse 95
OFF	ON	ON	OFF	OFF	OFF	OFF	OFF	Adresse 96
OFF	ON	ON	OFF	OFF	OFF	OFF	ON	Adresse 97
OFF	ON	ON	OFF	OFF	OFF	ON	OFF	Adresse 98
OFF	ON	ON	OFF	OFF	OFF	ON	ON	Adresse 99
OFF	ON	ON	OFF	OFF	ON	OFF	OFF	Adresse 100
OFF	ON	ON	OFF	OFF	ON	OFF	ON	Adresse 101
OFF	ON	ON	OFF	OFF	ON	ON	OFF	Adresse 102
OFF	ON	ON	OFF	OFF	ON	ON	ON	Adresse 103
OFF	ON	ON	OFF	ON	OFF	OFF	OFF	Adresse 104
OFF	ON	ON	OFF	ON	OFF	OFF	ON	Adresse 105
OFF	ON	ON	OFF	ON	OFF	ON	OFF	Adresse 106
OFF	ON	ON	OFF	ON	OFF	ON	ON	Adresse 107
OFF	ON	ON	OFF	ON	ON	OFF	OFF	Adresse 108
OFF	ON	ON	OFF	ON	ON	OFF	ON	Adresse 109
OFF	ON	ON	OFF	ON	ON	ON	OFF	Adresse 110
OFF	ON	ON	OFF	ON	ON	ON	ON	Adresse 111
OFF	ON	ON	ON	OFF	OFF	OFF	OFF	Adresse 112
OFF	ON	ON	ON	OFF	OFF	OFF	ON	Adresse 113
OFF	ON	ON	ON	OFF	OFF	ON	OFF	Adresse 114
OFF	ON	ON	ON	OFF	OFF	ON	ON	Adresse 115
OFF	ON	ON	ON	OFF	ON	OFF	OFF	Adresse 116
OFF	ON	ON	ON	OFF	ON	OFF	ON	Adresse 117
OFF	ON	ON	ON	OFF	ON	ON	OFF	Adresse 118
OFF	ON	ON	ON	OFF	ON	ON	ON	Adresse 119
OFF	ON	ON	ON	ON	OFF	OFF	OFF	Adresse 120
OFF	ON	ON	ON	ON	OFF	OFF	ON	Adresse 121
OFF	ON	ON	ON	ON	OFF	ON	OFF	Adresse 122
OFF	ON	ON	ON	ON	OFF	ON	ON	Adresse 123
OFF	ON	ON	ON	ON	ON	OFF	OFF	Adresse 124
OFF	ON	ON	ON	ON	ON	OFF	ON	Adresse 125
OFF	ON	ON	ON	ON	ON	ON	OFF	Adresse 126

CONFIGURATION DE L'ADRESSE (DIP 3)								
SW 8	SW 7	SW 6	SW 5	SW 4	SW 3	SW 2	SW 1	Adresse
OFF	ON	ON	ON	ON	ON	ON	ON	Adresse 127
ON	OFF	OFF	OFF	OFF	OFF	OFF	OFF	Adresse 128
ON	OFF	OFF	OFF	OFF	OFF	OFF	ON	Adresse 129
ON	OFF	OFF	OFF	OFF	OFF	ON	OFF	Adresse 130
ON	OFF	OFF	OFF	OFF	OFF	ON	ON	Adresse 131
ON	OFF	OFF	OFF	OFF	ON	OFF	OFF	Adresse 132
ON	OFF	OFF	OFF	OFF	ON	OFF	ON	Adresse 133
ON	OFF	OFF	OFF	OFF	ON	ON	OFF	Adresse 134
ON	OFF	OFF	OFF	OFF	ON	ON	ON	Adresse 135
ON	OFF	OFF	OFF	ON	OFF	OFF	OFF	Adresse 136
ON	OFF	OFF	OFF	ON	OFF	OFF	ON	Adresse 137
ON	OFF	OFF	OFF	ON	OFF	ON	OFF	Adresse 138
ON	OFF	OFF	OFF	ON	OFF	ON	ON	Adresse 139
ON	OFF	OFF	OFF	ON	ON	OFF	OFF	Adresse 140
ON	OFF	OFF	OFF	ON	ON	OFF	ON	Adresse 141
ON	OFF	OFF	OFF	ON	ON	ON	OFF	Adresse 142
ON	OFF	OFF	OFF	ON	ON	ON	ON	Adresse 143
ON	OFF	OFF	ON	OFF	OFF	OFF	OFF	Adresse 144
ON	OFF	OFF	ON	OFF	OFF	OFF	ON	Adresse 145
ON	OFF	OFF	ON	OFF	OFF	ON	OFF	Adresse 146
ON	OFF	OFF	ON	OFF	OFF	ON	ON	Adresse 147
ON	OFF	OFF	ON	OFF	ON	OFF	OFF	Adresse 148
ON	OFF	OFF	ON	OFF	ON	OFF	ON	Adresse 149
ON	OFF	OFF	ON	OFF	ON	ON	OFF	Adresse 150
ON	OFF	OFF	ON	OFF	ON	ON	ON	Adresse 151
ON	OFF	OFF	ON	ON	OFF	OFF	OFF	Adresse 152
ON	OFF	OFF	ON	ON	OFF	OFF	ON	Adresse 153
ON	OFF	OFF	ON	ON	OFF	ON	OFF	Adresse 154
ON	OFF	OFF	ON	ON	OFF	ON	ON	Adresse 155
ON	OFF	OFF	ON	ON	ON	OFF	OFF	Adresse 156
ON	OFF	OFF	ON	ON	ON	OFF	ON	Adresse 157
ON	OFF	OFF	ON	ON	ON	ON	OFF	Adresse 158
ON	OFF	OFF	ON	ON	ON	ON	ON	Adresse 159
ON	OFF	ON	OFF	OFF	OFF	OFF	OFF	Adresse 160
ON	OFF	ON	OFF	OFF	OFF	OFF	ON	Adresse 161
ON	OFF	ON	OFF	OFF	OFF	ON	OFF	Adresse 162
ON	OFF	ON	OFF	OFF	OFF	ON	ON	Adresse 163
ON	OFF	ON	OFF	OFF	ON	OFF	OFF	Adresse 164
ON	OFF	ON	OFF	OFF	ON	OFF	ON	Adresse 165
ON	OFF	ON	OFF	OFF	ON	ON	OFF	Adresse 166
ON	OFF	ON	OFF	OFF	ON	ON	ON	Adresse 167
ON	OFF	ON	OFF	ON	OFF	OFF	OFF	Adresse 168
ON	OFF	ON	OFF	ON	OFF	OFF	ON	Adresse 169
ON	OFF	ON	OFF	ON	OFF	ON	OFF	Adresse 170

CONFIGURATION DE L'ADRESSE (DIP 3)								
SW 8	SW 7	SW 6	SW 5	SW 4	SW 3	SW 2	SW 1	Adresse
ON	OFF	ON	OFF	ON	OFF	ON	ON	Adresse 171
ON	OFF	ON	OFF	ON	ON	OFF	OFF	Adresse 172
ON	OFF	ON	OFF	ON	ON	OFF	ON	Adresse 173
ON	OFF	ON	OFF	ON	ON	ON	OFF	Adresse 174
ON	OFF	ON	OFF	ON	ON	ON	ON	Adresse 175
ON	OFF	ON	ON	OFF	OFF	OFF	OFF	Adresse 176
ON	OFF	ON	ON	OFF	OFF	OFF	ON	Adresse 177
ON	OFF	ON	ON	OFF	OFF	ON	OFF	Adresse 178
ON	OFF	ON	ON	OFF	OFF	ON	ON	Adresse 179
ON	OFF	ON	ON	OFF	ON	OFF	OFF	Adresse 180
ON	OFF	ON	ON	OFF	ON	OFF	ON	Adresse 181
ON	OFF	ON	ON	OFF	ON	ON	OFF	Adresse 182
ON	OFF	ON	ON	OFF	ON	ON	ON	Adresse 183
ON	OFF	ON	ON	ON	OFF	OFF	OFF	Adresse 184
ON	OFF	ON	ON	ON	OFF	OFF	ON	Adresse 185
ON	OFF	ON	ON	ON	OFF	ON	OFF	Adresse 186
ON	OFF	ON	ON	ON	OFF	ON	ON	Adresse 187
ON	OFF	ON	ON	ON	ON	OFF	OFF	Adresse 188
ON	OFF	ON	ON	ON	ON	OFF	ON	Adresse 189
ON	OFF	ON	ON	ON	ON	ON	OFF	Adresse 190
ON	OFF	ON	ON	ON	ON	ON	ON	Adresse 191
ON	ON	OFF	OFF	OFF	OFF	OFF	OFF	Adresse 192
ON	ON	OFF	OFF	OFF	OFF	OFF	ON	Adresse 193
ON	ON	OFF	OFF	OFF	OFF	ON	OFF	Adresse 194
ON	ON	OFF	OFF	OFF	OFF	ON	ON	Adresse 195
ON	ON	OFF	OFF	OFF	ON	OFF	OFF	Adresse 196
ON	ON	OFF	OFF	OFF	ON	OFF	ON	Adresse 197
ON	ON	OFF	OFF	OFF	ON	ON	OFF	Adresse 198
ON	ON	OFF	OFF	OFF	ON	ON	ON	Adresse 199
ON	ON	OFF	OFF	ON	OFF	OFF	OFF	Adresse 200
ON	ON	OFF	OFF	ON	OFF	OFF	ON	Adresse 201
ON	ON	OFF	OFF	ON	OFF	ON	OFF	Adresse 202
ON	ON	OFF	OFF	ON	OFF	ON	ON	Adresse 203
ON	ON	OFF	OFF	ON	ON	OFF	OFF	Adresse 204
ON	ON	OFF	OFF	ON	ON	OFF	ON	Adresse 205
ON	ON	OFF	OFF	ON	ON	ON	OFF	Adresse 206
ON	ON	OFF	OFF	ON	ON	ON	ON	Adresse 207
ON	ON	OFF	ON	OFF	OFF	OFF	OFF	Adresse 208
ON	ON	OFF	ON	OFF	OFF	OFF	ON	Adresse 209
ON	ON	OFF	ON	OFF	OFF	ON	OFF	Adresse 210
ON	ON	OFF	ON	OFF	OFF	ON	ON	Adresse 211
ON	ON	OFF	ON	OFF	ON	OFF	OFF	Adresse 212
ON	ON	OFF	ON	OFF	ON	OFF	ON	Adresse 213
ON	ON	OFF	ON	OFF	ON	ON	OFF	Adresse 214

CONFIGURATION DE L'ADRESSE (DIP 3)								
SW 8	SW 7	SW 6	SW 5	SW 4	SW 3	SW 2	SW 1	Adresse
ON	ON	OFF	ON	OFF	ON	ON	ON	Adresse 215
ON	ON	OFF	ON	ON	OFF	OFF	OFF	Adresse 216
ON	ON	OFF	ON	ON	OFF	OFF	ON	Adresse 217
ON	ON	OFF	ON	ON	OFF	ON	OFF	Adresse 218
ON	ON	OFF	ON	ON	OFF	ON	ON	Adresse 219
ON	ON	OFF	ON	ON	ON	OFF	OFF	Adresse 220
ON	ON	OFF	ON	ON	ON	OFF	ON	Adresse 221
ON	ON	OFF	ON	ON	ON	ON	OFF	Adresse 222
ON	ON	OFF	ON	ON	ON	ON	ON	Adresse 223
ON	ON	ON	OFF	OFF	OFF	OFF	OFF	Adresse 224
ON	ON	ON	OFF	OFF	OFF	OFF	ON	Adresse 225
ON	ON	ON	OFF	OFF	OFF	ON	OFF	Adresse 226
ON	ON	ON	OFF	OFF	OFF	ON	ON	Adresse 227
ON	ON	ON	OFF	OFF	ON	OFF	OFF	Adresse 228
ON	ON	ON	OFF	OFF	ON	OFF	ON	Adresse 229
ON	ON	ON	OFF	OFF	ON	ON	OFF	Adresse 230
ON	ON	ON	OFF	OFF	ON	ON	ON	Adresse 231
ON	ON	ON	OFF	ON	OFF	OFF	OFF	Adresse 232
ON	ON	ON	OFF	ON	OFF	OFF	ON	Adresse 233
ON	ON	ON	OFF	ON	OFF	ON	OFF	Adresse 234
ON	ON	ON	OFF	ON	OFF	ON	ON	Adresse 235
ON	ON	ON	OFF	ON	ON	OFF	OFF	Adresse 236
ON	ON	ON	OFF	ON	ON	OFF	ON	Adresse 237
ON	ON	ON	OFF	ON	ON	ON	OFF	Adresse 238
ON	ON	ON	OFF	ON	ON	ON	ON	Adresse 239
ON	ON	ON	ON	OFF	OFF	OFF	OFF	Adresse 240
ON	ON	ON	ON	OFF	OFF	OFF	ON	Adresse 241
ON	ON	ON	ON	OFF	OFF	ON	OFF	Adresse 242
ON	ON	ON	ON	OFF	OFF	ON	ON	Adresse 243
ON	ON	ON	ON	OFF	ON	OFF	OFF	Adresse 244
ON	ON	ON	ON	OFF	ON	OFF	ON	Adresse 245
ON	ON	ON	ON	OFF	ON	ON	OFF	Adresse 246
ON	ON	ON	ON	OFF	ON	ON	ON	Adresse 247
ON	ON	ON	ON	ON	OFF	OFF	OFF	Adresse 248
ON	ON	ON	ON	ON	OFF	OFF	ON	Adresse 249
ON	ON	ON	ON	ON	OFF	ON	OFF	Adresse 250
ON	ON	ON	ON	ON	OFF	ON	ON	Adresse 251
ON	ON	ON	ON	ON	ON	OFF	OFF	Adresse 252
ON	ON	ON	ON	ON	ON	OFF	ON	Adresse 253
ON	ON	ON	ON	ON	ON	ON	OFF	Adresse 254
ON	ON	ON	ON	ON	ON	ON	ON	Adresse 255

Tab. 21

Headquarters Italy Videotec S.p.A.

Via Friuli, 6 - I-36015 Schio (VI) - Italy

Tel. +39 0445 697411 - Fax +39 0445 697414

Email: info@videotec.com

Asia Pacific Videotec (HK) Ltd

Flat 8, 19/F. On Dak Industrial Building, No. 2-6 Wah Sing Street

Kwai Chung, New Territories - Hong Kong

Tel. +852 2333 0601 - Fax +852 2311 0026

Email: info.hk@videotec.com

France Videotec France SARL

Immeuble Le Montreal, 19bis Avenue du Québec, ZA de Courtaboeuf
91140 Villebon sur Yvette - France

Tel. +33 1 60491816 - Fax +33 1 69284736

Email: info.fr@videotec.com

Americas Videotec Security, Inc.

Gateway Industrial Park, 35 Gateway Drive, Suite 100
Plattsburgh, NY 12901 - U.S.A.

Tel. +1 518 825 0020 - Fax +1 518 825 0022

Email: info.usa@videotec.com - www.videotec.com



www.videotec.com

MNVCUPTMAXB_1511_FR

ULISSE MAXI

PTZ Einheit für die dynamische Überwachung großer Aussenbereiche

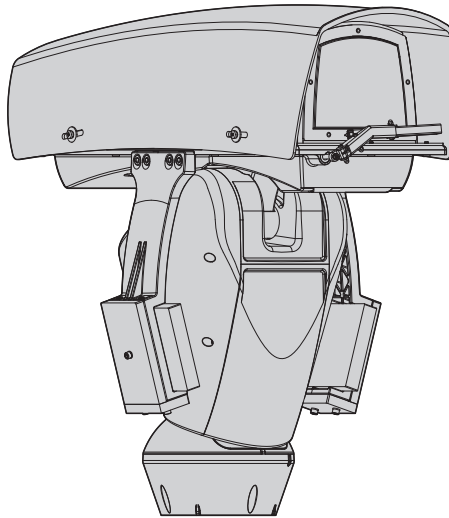

Inhaltsverzeichnis

1 Allgemeines	7
1.1 Schreibweisen.....	7
2 Anmerkungen zum Copyright und Informationen zu den Handelsmarken.....	7
3 Sicherheitsnormen	7
4 Identifizierung	10
4.1 Beschreibung und Bezeichnung des Produktes.....	10
4.2 Kennzeichnung des Produkts.....	10
4.2.1 Prüfung der Kennzeichnung	10
5 Versionen.....	11
5.1 LED Scheinwerfer.....	11
5.2 Fensterscheibe aus Germanium.....	11
6 Vorbereitung des Produktes auf den Gebrauch.....	12
6.1 Sicherheitsvorkehrungen vor dem Gebrauch.....	12
6.2 Entfernen der Verpackung	12
6.3 Inhalt	12
6.4 Sichere Entsorgung der Verpackungsmaterialien	12
6.5 Auf die Installation vorbereitende Tätigkeiten.....	13
6.5.1 Befestigung der Halterung.....	13
6.5.2 Kabelführung	13
7 Zusammenbau	14
7.1 Befestigung des Dachs	14
7.2 Öffnung des Schutzgehäuse	14
7.3 Montage Kamera und motorisch bewegte Optiken.....	14
7.3.1 Eigenschaften der Kameras	14
7.3.2 Befestigung der Optik und der Kamera am Innenschlitten.....	15
7.3.3 Positionierung des Abstandhalters H-20 auf dem Innenschlitten.....	16
7.3.4 Innenschlittens.....	16
7.4 Beschreibung der Karte Gehäuse	17
7.4.1 Anschluss der Kamera und der motorisch bewegten Optik.....	17
7.4.2 Einstellung der Versorgungsspannung der Motoren der Optiken	18
8 Installation	19
8.1 Anschließen der Kabel an die Basis.....	19
8.2 Befestigung der Basis an der Halterung	20
8.3 Beschreibung der Karte Anschlüsse	21
8.4 Anschluss der Stromversorgung.....	22
8.4.1 Anschluss der Stromversorgungslinie 24Vac	23
8.4.2 Anschluss der Versorgungsleitung in 120Vac und 230Vac.....	23
8.5 Anschluss der Signalkabel.....	24
8.5.1 Anschluss des Videokabels	24
8.5.2 Anschluss der Telemetrieleitungen.....	25
8.5.3 Anschluss der Alarmeingänge, der Dämmerungsschalter und der Relais	26

8.6 Befestigung des oberen Körpers.....	27
8.7 Aufbau der Gegengewichte.....	27
8.8 Montage der Scheinwerfer mit LED.....	28
8.8.1 Entfernen der Gegengewichte.....	28
8.8.2 Montage des Scheinwerfers auf den Bügel.....	28
8.9 Anschluss der LED-Scheinwerfer.....	29
8.10 Anschluss für die Synchronisierung der Kameras mit den LED-Scheinwerfern.....	30
8.11 Trockenmittelbeutel.....	30
8.12 Einstellung und Aktivierungsarten der LED-Scheinwerfer.....	30
8.12.1 Beschreibung des LED-Scheinwerfers.....	30
8.12.2 Aktivierung der LED-Scheinwerfer durch einen externen Dämmerungsschalter.....	31
8.12.3 Aktivierung der LED-Scheinwerfer durch den integrierten Dämmerungssensor.....	31
8.12.4 Einstellung der Einschaltsschwelle der LED-Scheinwerfer.....	32
8.12.5 Einstellung der Leistung der LED-Scheinwerfer.....	32
8.13 Befestigung des Wischerblattes.....	33
8.14 Hardware Konfiguration.....	34
8.14.1 Öffnen der Konfigurationsklappe.....	34
8.14.2 Konfiguration der DIP1.....	34
8.14.3 Konfiguration von DIP2.....	34
8.14.4 Konfiguration von DIP3.....	35
8.14.4.1 Adressenkonfiguration.....	35
8.14.4.2 Die Leitungen der seriellen Datenübertragung konfigurieren.....	35
8.14.5 Konfiguration von DIP4.....	35
8.14.6 Montagebeispiel.....	36
8.14.6.1 Leitung RS-485 RX.....	36
8.14.6.2 Leitung RS-422 (RS-485-1 RX e RS-485-2 TX).....	36
8.14.6.3 Leitung 1 RS-485 Empfang, Leitung 2 RS-485 Wiederholung.....	36
8.14.6.4 Leitung RS-485 TX/RX bidirektional.....	36
9 Einschaltung.....	37
9.1 Erstes Einschalten.....	37
9.2 Liste der Kontrollen.....	37
10 Konfiguration.....	38
10.1 OSM-Schnittstelle (On Screen Menu).....	38
10.1.1 Gebrauch des OSM.....	38
10.1.1.1 Verwendung des Steuerknüppels.....	38
10.1.1.2 Das Bewegen innerhalb der Menüs.....	39
10.1.1.3 Ändern von Parametern.....	39
10.1.1.4 Ändern der Zahlenfelder.....	40
10.1.1.5 Ändern von Texten.....	40
10.1.2 Konfiguration über OSM.....	42
10.1.3 Hauptmenü.....	42
10.1.4 Menü Sprachwahl.....	42
10.1.5 Menü Parameter ZFI.....	42
10.1.5.1 Menü Zonenbetitelung.....	43
10.1.5.2 Menü Zonenmaskierung.....	44
10.1.6 Menü Gehäuse seriell.....	45
10.1.7 Menü Polarität.....	45
10.1.8 Menü Bewegung.....	46
10.1.8.1 Menü Handsteuerung.....	46

10.1.8.2 Menü Handsteuerung (Grenzpunkte)	47
10.1.8.3 Menü Preset	47
10.1.8.4 Menü Preset (Preset Ändern)	47
10.1.8.5 Menü Preset (Utility Preset)	48
10.1.8.6 Menü Patrol	48
10.1.8.7 Menü Autopan	48
10.1.8.8 Menü Bewegungsanforderung	49
10.1.9 Menü Anzeigen	49
10.1.10 Menü I/O Digital-Optionen	49
10.1.10.1 Menü Alarme	50
10.1.10.2 Menü Kommunikationen	50
10.1.10.3 Menü Waschanlage	51
10.1.11 Menü Default	51
10.1.12 Menü Info	51
11 Zubehör	52
11.1 Waschanlage	52
11.1.1 Anschluss der Waschanlage	52
11.2 Wandhalterung	53
11.3 Halterung für Brüstungsmontage	53
11.4 Netzteil mit Steuerung der Scheinwerfer	53
12 Anleitung für den normalen Betrieb	54
12.1 Statusanzeige Schwenk-Neige-Kopf	54
12.2 Speichern eines Preset	54
12.3 Aufruf einer Position Preset (Scan)	54
12.4 Aufruf der Homeposition	54
12.5 Aktivierung Patrol	54
12.6 Aktivierung Autopan	55
12.7 Aktivierung der Scheibenwischer (Wiper)	55
12.8 Aktivierung der Waschanlage (Washer)	55
12.9 Aktivierung des LED- Scheinwerfer	55
12.10 Reboot der Einheit	55
12.11 Spezialbefehle	56
12.12 Sonderkonfigurationen	57
13 Wartung	58
13.1 Wechsel der Sicherungen	58
14 Reinigung	58
14.1 Reinigung des Glases und der Kunststoffteile	58
14.2 Putzen des Germaniumfensters	58
15 Müllentsorgungsstellen	58
16 Problemlösung	59
17 Technische Daten	61
17.1 Allgemeines	61
17.2 Mechanik	61
17.3 Fenster für Gehäuse	61
17.4 Elektrik	61

17.5 Video	62
17.6 Kommunikation	62
17.7 Protokolle	62
17.8 I/O-Schnittstelle	62
17.9 Optiken	62
17.10 Umgebung	62
17.11 Zertifizierungen	62
18 Technische Zeichnungen.....	63
A Anhang - Adressentabelle	66

1 Allgemeines

Vor Installation und Anwendung der Einheit ist die gesamte gelieferte Dokumentation aufmerksam zu lesen. Zum späteren Nachschlagen das Handbuch in Reichweite aufbewahren.

1.1 Schreibweisen



GEFAHR!

Erhöhte Gefährdung.
Stromschlaggefahr. Falls nichts anderes angegeben, unterbrechen Sie die Stromversorgung, bevor die beschriebenen Arbeiten durchgeführt werden.



GEFAHR!

Heiße Oberfläche.
Nicht berühren. Die Oberflächen sind heiß und können bei Berührung zu Verbrennungen führen.



GEFAHR!

Gefahr mechanischer Natur.
Quetsch- oder Scherkantengefahr.



ACHTUNG!

Mittlere Gefährdung.
Der genannte Vorgang hat große Bedeutung für den einwandfreien Betrieb des Systems: es wird gebeten, sich die Verfahrensweise anzulesen und zu befolgen.



ANMERKUNG

Beschreibung der Systemmerkmale.
Eine sorgfältige Lektüre wird empfohlen, um das Verständnis der folgenden Phasen zu gewährleisten.

2 Anmerkungen zum Copyright und Informationen zu den Handelsmarken

Die angeführten Produkt- oder Firmennamen sind Handelsmarken oder eingetragene Handelsmarken.

3 Sicherheitsnormen



ACHTUNG! Die elektrische Anlage, an der die Einheit angeschlossen ist, muss mit einem automatischen zweipoligen Schutzschalter 20A max ausgestattet sein. Dieser Schalter muss vom Typ Listed sein. Zwischen den Schutzschalter Kontakten muss mindestens ein Abstand von 3mm vorhanden sein. Der Schalter muss eine Schutzrichtung gegen Erde Fehlerstrom (Differenzial) und gegen Überstrom haben (magnetothermisch).



ACHTUNG! Gefährliche Loseile. Finger und andere Körperteile fernhalten.



ACHTUNG! Die Installation und Wartung der Vorrichtung ist technischen Fachleuten vorbehalten.



ACHTUNG! Damit ein ständiger Brandschutz garantiert wird, sind die Sicherungen nur in dem gleichen Typ und Wert zu ersetzen. Die Sicherungen sind nur von Fachleuten zu ersetzen.



ACHTUNG! Die Anlage gehört zum Typ TNV-1. Nicht an Kreisläufe SELV anschließen.



ACHTUNG! Zur Senkung der Brandgefahr dürfen nur UL Listed oder CSA zertifizierte Kabel benutzt werden, die mindestens dem Schnitt 0.14mm² (26AWG) entsprechen.

- Der Hersteller lehnt jede Haftung für eventuelle Schäden ab, die aufgrund unsachgemäßer Anwendung der in diesem Handbuch erwähnten Geräte entstanden ist. Ferner behält er sich das Recht vor, den Inhalt ohne Vorkündigung abzuändern. Die Dokumentation in diesem Handbuch wurde sorgfältig ausgeführt und überprüft. Der Hersteller kann dennoch keine Haftung für die Verwendung übernehmen. Dasselbe gilt für jede Person oder Gesellschaft, die bei der Schaffung oder Produktion von diesem Handbuch miteinbezogen ist.

- Unterbrechen Sie die Stromversorgung, bevor die beschriebenen Arbeiten durchgeführt werden.
- Es dürfen keine Kabel mit Verschleiß- oder Alterungsspuren verwendet werden.
- Unter keinen Umständen dürfen Veränderungen oder Anschlüsse vorgenommen werden, die in diesem Handbuch nicht genannt sind. Der Gebrauch ungeeigneten Geräts kann die Sicherheit des Personals und der Anlage schwer gefährden.
- Es dürfen nur Original-Ersatzteile verwendet werden. Nicht originale Ersatzteile können zu Bränden, elektrischen Entladungen oder anderen Gefahren führen.
- Vor der Installation ist anhand des Kennzeichnungsschildes nachzuprüfen, ob das gelieferte Material die gewünschten Eigenschaften (4.2 Kennzeichnung des Produkts, Seite 10).
- Die Installationskategorie (auch als Überspannungskategorie bezeichnet) gibt den Pegel der Netzspannungsstöße an, denen die Ausrüstung ausgesetzt ist. Die Kategorie hängt vom Installationsort der Ausrüstung und von den externen Schutzeinrichtungen gegen Spannungsstöße ab. Ausrüstungen in einer gewerblichen Umgebung, die direkt mit den Hauptzweigen der Versorgungsanlage verbunden sind, gehören zur Installationskategorie III. In diesem Fall ist eine Abstufung auf Installationskategorie II erforderlich. Alternativ können UL listed Überspannungsschutzvorrichtungen (SPD) von Fase zu Nullleiter und von Nullleiter zur Erde geführt werden. UL-gelistete Überspannungsschutzvorrichtungen sind für die wiederholte Begrenzung kurzzeitig auftretender Spannungsspitzen und für die folgenden nominellen Betriebsbedingungen auszulegen: Typ 2 (Dauerhaft angeschlossene Überspannungsschutzvorrichtungen für die Installation auf der Ladungsseite der Hilfseinrichtung); Nennentladestrom (In) 20kA min. Benutzt werden können beispielsweise: FERRAZ SHAWMUT, STT2240SPG-CN, STT2BL240SPG-CN, spezifiziert für 120Vac/240Vac, (In=20kA). Der maximale Abstand zwischen dem Einbau und der Abkürzung ist 5m.
- Die Einrichtung ist für die dauerhafte Befestigung und Verbindung in ein Gebäude oder eine andere geeignete Struktur konzipiert. Vor jeder Operation muss die Einrichtung dauerhaft befestigt und verbunden werden.
- Die elektrische Anlage muss mit einem Netztrennschalter versehen sein, der im Bedarfsfall sofort erkannt und gebraucht werden kann.
- Der im Gerät verfügbare Erdungsanschluss muss ständig geerdet sein.
- Vorgeschrieben ist der Anschluss an eine Versorgungsquelle, deren Eigenschaften den Angaben auf dem Kennzeichnungsschild entsprechen. Vor der Installation ist zu prüfen, ob die Stromleitung sachgerecht abgetrennt ist. Die Versorgungsspannung darf die Toleranzen ($\pm 10\%$) nicht überschreiten.
- Die Vorrichtung mit einer isolierten Quelle Typ SELV 24Vac, 8A versorgen, von einem Transformator mit doppelter Isolierung UL Listed kommend, der entsprechend am Ausgang geschützt ist.
- Die Einrichtung ist so zu montieren, dass sie für keine andere Person als den Techniker oder Installateur zugänglich ist. Da sie mit beweglichen Teilen ausgestattet ist, bleibt ein Restrisiko, sich an den Bewegungselementen zu verletzen.
- Bringen Sie das Schildchen Gefährliche Bewegungsteile in der Nähe der Einrichtung an. (Abb. 4, Seite 12).
- Das Gerät nicht in der Nähe entzündlicher Stoffe benutzen.
- Für den Anschluss der Versorgungsleitung den entsprechenden Anschlusskasten verwenden (UPTJBUL). Für weitere Informationen siehe Bedienungs- und Installationshandbuch des Produktes.

- Kindern oder unbefugten Personen ist der Gebrauch des Gerätes zu untersagen.
- Die Wartung der Einrichtung ist Fachleuten vorbehalten. Während der Wartungsarbeiten ist die tätige Person der Gefahr von Stromschlägen und anderen Gefahren ausgesetzt.
- Verwenden Sie nur vom Hersteller empfohlenes Zubehör. Jede vom Hersteller nicht ausdrücklich genehmigte Veränderung führt zum Verfall der Gewährleistungsrechte.
- Erden Sie das Koaxialkabel.
- Vor dem Anschluss sämtlicher Signalkabel ist zu prüfen, ob die Einrichtung sachgerecht mit dem Erdungskreis verbunden ist.
- Wenn die Einrichtung von der Anlage getrennt werden muss, ist das Erdungskabel stets zuletzt abzuklemmen.
- Vermeiden Sie durch gebotene Vorkehrungen, dass das Gerät durch elektrostatische Entladungen beschädigt wird.
- Die Einheit ist dafür ausgelegt, über ein dreipoliges Kabel angeschlossen zu werden. Folgen Sie den Anleitungen in diesem Handbuch für den korrekten Anschluss des Erdungskreises.
- Die Einrichtung ist vorsichtig zu handhaben, starke mechanische Beanspruchungen könnten sie beschädigen.
- Achten Sie besonders auf die Isolierabstände zwischen der Versorgungsleitung und allen anderen Kabeln einschließlich der Vorrichtungen zum Schutz gegen Blitzeinschlag.
- Die Einrichtung darf nur mit größter Vorsicht transportiert werden. Ruckartige Haltemanöver, Höhenunterschiede und starke Aufpralle können das Objekt schädigen oder den Benutzer verletzen.

4 Identifizierung

4.1 Beschreibung und Bezeichnung des Produktes

ULISSE MAXI ist eine robuste und effiziente PTZ-Einheit, die entwickelt wurde, um eine dynamische Nonstop-Überwachung von großen Außenbereichen zu garantieren und beständig gegen schwierige Witterungsbedingungen zu sein.

Dieses Modell kann die größten auf dem Markt erhältlichen motorisierten Objektive bis zu fast 8 kg Gesamtgewicht aufnehmen.

Mit einer einzigen Einheit kann auf diese Weise eine 360°-Deckung des Überwachungsbereichs garantiert werden.

Um detaillierte Bilder auch in der Nacht zu garantieren, sind Versionen mit LED- und Infrarotscheinwerfern oder mit Scheinwerfern mit weißem Licht erhältlich.

Die robuste mechanische Struktur und die leistungsstarken Motoren dieser PTZ-Optik wurden entwickelt, um bei hohen Funktionsbelastungen, Vibrationen und Temperaturen von -10°C bis 60°C maximale Beständigkeit zu gewährleisten.

Die Einheit ist mit optischen Sensoren ausgestattet, die die genaue Kontrolle der Position unter jeder Verwendungsbedingung garantieren.

Die Einheit ist mit einem Scheibenwischer für die Reinigung der Frontscheibe von Regen und Staub ausgerüstet; es ist eine große Auswahl an Kanistern mit Scheibenwaschpumpe mit unterschiedlichen Fassungsvermögen und Förderhöhen erhältlich.

Es sind Modelle für die Sicht mit thermischer Videokamera erhältlich.

4.2 Kennzeichnung des Produkts

i Auf den Schwenk-Neige-Köpfen befindet sich ein Schildchen, das der CE-Kennzeichnung entspricht.



Abb. 1

Das Schildchen nennt:

- Identifizierungscode des Modells (Strichcode Extended 3/9).
- Versorgungsspannung (Volt).
- Frequenz (Hertz).
- Stromaufnahme (Ampere).
- Schutzart (IP).
- Seriennummer.

4.2.1 Prüfung der Kennzeichnung

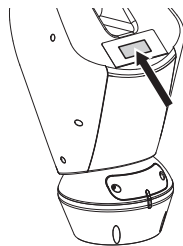
Vor Beginn der Installationsarbeiten ist zu kontrollieren, ob das gelieferte Material den jeweiligen Anforderungen entspricht. Zu erkennen ist dies anhand der Kennzeichnungsschilder.

Unter keinen Umständen dürfen Veränderungen oder Anschlüsse vorgenommen werden, die in diesem Handbuch nicht genannt sind. Der Gebrauch ungeeigneten Geräts kann die Sicherheit des Personals und der Anlage schwer gefährden.

5 Versionen

5.1 LED Scheinwerfer



Die Version mit LED- Scheinwerfern kann nur mit einer Spannung von 24Vac betrieben werden.

Der S-N-Kopf kann mit einer Halterung für 2 VIDEOTEC LED- Scheinwerfer für die Nachtüberwachung (Scheinwerfer nicht eingeschlossen).



Abb. 2



Für weitere Infos bitte entsprechendes Kapitel beachten (8.8 Montage der Scheinwerfer mit LED, Seite 28).

5.2 Fensterscheibe aus Germanium

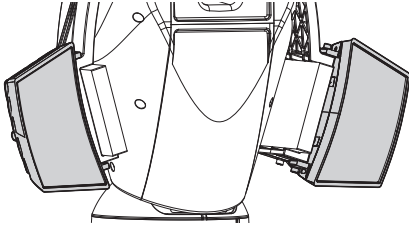
Die Version ist mit Fensterscheibe aus Germanium ausgestattet, die eigens für Anlagen mit Wärmebildkameras ausgelegt ist.



Abb. 3

6 Vorbereitung des Produktes auf den Gebrauch



Jede vom Hersteller nicht ausdrücklich genehmigte Veränderung führt zum Verfall der Gewährleistungsrechte.

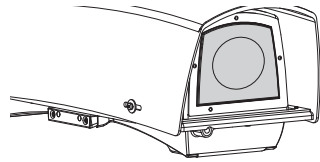

Die Einheit darf nicht auseinandergebaut werden, und es dürfen keine Veränderungen daran vorgenommen werden. Ausnahmen sind nur die Montage- und Wartungsarbeiten, die laut dieser Anleitung vorgesehen sind.

6.1 Sicherheitsvorkehrungen vor dem Gebrauch



Das Gerät umfasst bewegliche Teile. Stellen Sie sicher, dass die Einheit an einer Stelle positioniert wird, die unter normalen Betriebsbedingungen nicht zugänglich ist. Bringen Sie das im Lieferumfang des Gerätes enthaltene Schildchen in der Nähe des Objektes an gut sichtbarer Stelle an.



Abb. 4

6.2 Entfernen der Verpackung

Bei der Lieferung des Produktes ist zu prüfen, ob die Verpackung intakt ist oder offensichtliche Anzeichen von Stürzen oder Abrieb aufweist.

Bei offensichtlichen Schadensspuren an der Verpackung muss umgehend der Lieferant verständigt werden.

Bewahren Sie die Verpackung auf für den Fall, dass das Produkt zur Reparatur eingeschendet werden muss.



Die Haube der Vorrichtung Einrichtung vorsichtig auspacken, damit das Gehäuse keinen Schaden nimmt.

6.3 Inhalt

Prüfen Sie, ob der Inhalt mit der nachstehenden Materialliste übereinstimmt:

- Positionierungseinheit
- Basis für Netzstromversorgung
- Zubehör Packung:
 - Serieller Adapter
 - Seriell Verlängerungskabel
 - Innensechskantschlüssel
 - Abstandsstücke
 - Abstandsstücke (nicht vorhanden bei der Version mit integrierter Videokamera)
- Schildchen
- Kabelbinder
- Silikonummantelung
- Reduzierdichtungen für Kabelverschraubungen
- Bedienungsanleitung
- Befestigungsplatte für Beutelchen
- Trockenmittelbeutel
- Schrauben
- Gegengewichte Packung:
- Befestigungsbügel für LED-Scheinwerfer (vorhanden bei den Versionen mit LED-Scheinwerfern)
 - Gegengewichte
 - Halterungen für Gegengewichte
- Sonnenschutzdach

6.4 Sichere Entsorgung der Verpackungsmaterialien

Die Verpackungsmaterialien sind vollständig wiederverwertbar. Es ist Sache des Installationstechnikers, sie getrennt, auf jeden Fall aber nach den geltenden Vorschriften des Anwendungslandes zu entsorgen.

Im Falle der Rückgabe des nicht korrekt funktionierenden Produktes empfiehlt sich die Verwendung der Originalverpackung für den Transport.

6.5 Auf die Installation vorbereitende Tätigkeiten

6.5.1 Befestigung der Halterung

! Im Falle von Installationen, die Vibrationen ausgesetzt sind, nur die Brüstungshalterung verwenden.

Verschiedene Halterungen sind (11 Zubehör, Seite 52). Das geeignetste für die Installation auswählen und alle Angaben aus diesem Kapitel befolgen.

! Besondere Aufmerksamkeit verlangen die Befestigungssysteme des Gerätes. Das Befestigungssystem muss in jedem Fall in der Lage sein, mindestens das 4 fache Gewicht der gesamten Appartur mitsamt S-N-Kopf, Linsen und Kamera zu tragen.

! Die Einrichtung muss in senkrechter Lage montiert werden. Jede andere Stellung könnte die Leistungen des Gerätes beeinträchtigen.

! Den Schwenk-Neige-Kopf nicht umgekehrt montieren.

6.5.2 Kabelführung

! Die Verbindungskabel dürfen von außen nicht zugänglich sein. Die Kabel müssen gegen Lösen durch Abziehen sachgerecht am Träger fixiert werden, damit es verhindert wird, dass es durch das hohe Gewicht unbeabsichtigt abgezogen wird.

! Die verwendeten Kabel müssen der Anlagenart angemessen sein.

Die Kabel so in die Halterung einführen, dass sie ungefähr 50cm hervorschauen.



Abb. 5

7 Zusammenbau

7.1 Befestigung des Dachs

Die Haube mit den 4 Schrauben und den 4 Paaren Unterlegscheiben aus dem Lieferumfang am Gehäuse fixieren.

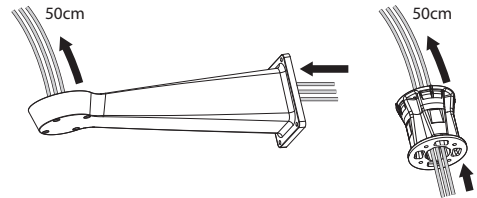

Abb. 6

7.2 Öffnung des Schutzgehäuse

Die lecksicheren Schrauben an den Seiten lösen, den oberen Teil des Gehäuses anheben.

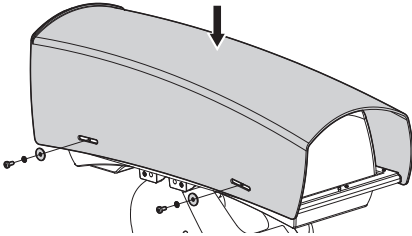

Abb. 7

i Nach Beendigung der Installation und der Verkabelung das Produkt wieder schließen.

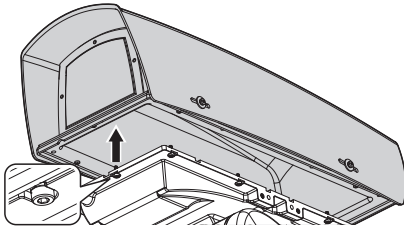

Abb. 8

i Die beiden zentralen Schrauben als erstes festziehen wie in der Abbildung dargestellt.

7.3 Montage Kamera und motorisch bewegte Optiken

Die Kamera und die zugehörigen Objektive sind vom Kunden selbst zu montieren.

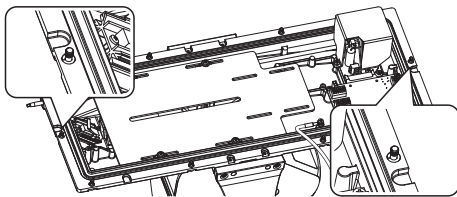
7.3.1 Eigenschaften der Kameras

! Der korrekte Betrieb des Gerätes innerhalb des angezeigten Temperaturbereichs ist nur garantiert, wenn die Temperaturschwellen der verwendeten Kamera und Optik mindestens zwischen -10°C und $+60^{\circ}\text{C}$ liegen.

- Die Versorgungsspannung der Kamera muss 12Vdc betragen.
- Die maximale Stromaufnahme der Kamera muss unter dem nachfolgenden Wert liegen: 800mA.
- Das von der Kamera abgehende Videosignal muss ein Composite-Signal mit einer Amplitude von 1Vpp sein (sync negativ).

7.3.2 Befestigung der Optik und der Kamera am Innenschlitten

! Der Kamerakörper muss vom Befestigungsschlitten isoliert werden, um Videosignalstörungen vorzubeugen.

! Das für Kamera und Optik zulässige maximale Gesamtgewicht darf 7.6kg nicht überschreiten.

Die Kamera (02) mit der Optik (01) zusammenstecken. Den kleinen L-Bügel aus Aluminium (03) mit der Unterlegscheibe aus Nylon (04) und der Schraube 1/4" (05) an der Kamera befestigen.



Abb. 9

Die Optik auf dem Schlitten (02) positionieren. Dabei den Abstandhalter aus Plastik zwischenlegen (01). Das Ganze mit der Unterlegscheibe aus Nylon (03) und der Schraube 1/4" (04) fixieren.

Falls erforderlich, zur korrekten Positionierung von Kamera und Optik die zusätzlich vorhandenen Abstandhalter benutzen.

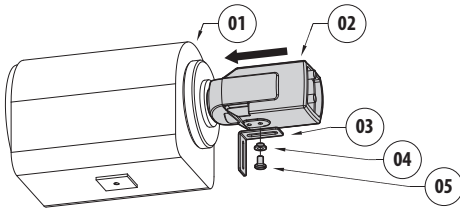

Abb. 10

Die Aluminiumplatte (01) mit den Schrauben und den zugehörigen Unterlegscheiben (02) auf dem Schlitten befestigen.

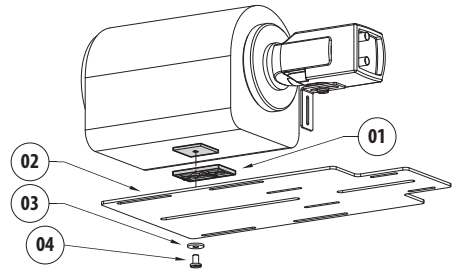

Abb. 11

Den L-Bügel mit der Schraube fixieren.

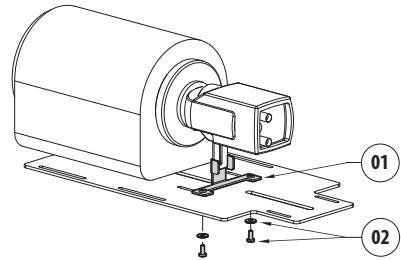

Abb. 12

7.3.3 Positionierung des Abstandhalters H-20 auf dem Innenschlitten

Es ist möglich einen H-20 Abstandhalter (02) an der Optik zu befestigen. Die Kamera zusammenstecken und die L-Bügel befestigen (Abb. 9, Seite 15). Legen Sie einen Abstandhalter aus Plastik (01) in der gewünschten Dicke dazwischen und befestigen Sie ihn mit Unterlegscheibe und Schraube (03).

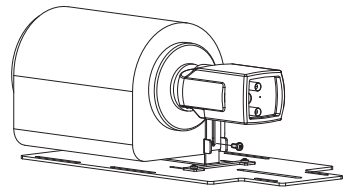

Abb. 13

Die Optik mit dem Abstandhalter im Innenschlitten (01) positionieren und den Abstandhalter mit den Unterlegscheiben und Schrauben (02) aus dem Lieferumfang fixieren.

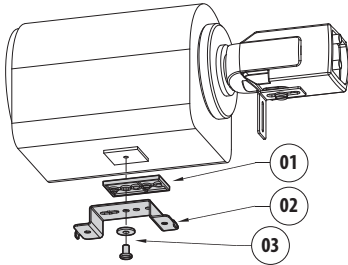

Abb. 14

Die Befestigung wie in den Bildern gezeigt beenden (Abb. 11, Seite 15 e Abb. 12, Seite 15).

7.3.4 Innenschlittens

Den Innenschlitten mit der Optik und der Kamera, beides bereits befestigt, in die gewünschte Position gleiten lassen und dort mit den Unterlegscheiben und Schrauben aus dem Lieferumfang fixieren.

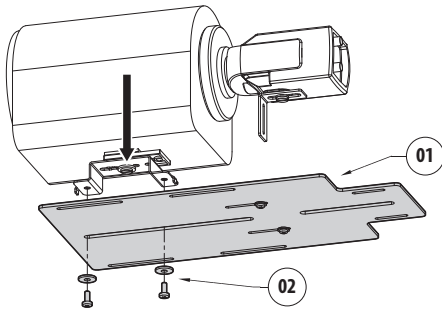

Abb. 15

Optiken mit Motoren mit umgekehrter Polarität:

Den Anschluss wie in der Abbildung gezeigt ausführen..

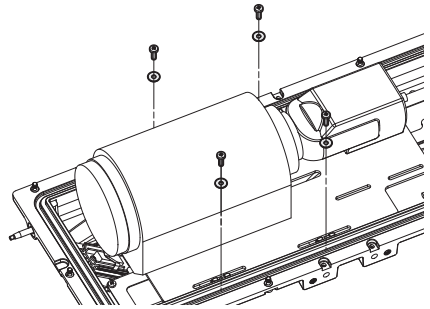

Abb. 17 CN2.

Optiken mit Motoren mit gemeinsamem Leiter:

Den Anschluss wie in der Abbildung gezeigt ausführen..

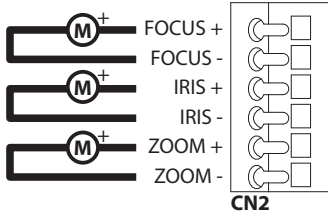

Abb. 18 CN2.

Potentiometer: Den Anschluss wie in der Abbildung gezeigt ausführen..

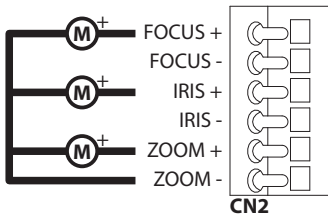

Abb. 19 CN3.

Kamera: Den Anschluss wie in der Abbildung gezeigt ausführen..

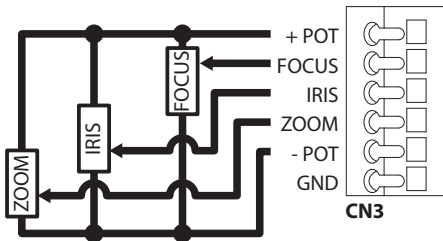

Abb. 20

Um die Steuerung der Videokamera zu aktivieren, bitte entsprechendes Kapitel beachten (10.1.6 Menü Gehäuse seriell, Seite 45).

7.4.2 Einstellung der Versorgungsspannung der Motoren der Optiken

Bevor die Stromversorgung des Schwenk-Neige-Kopfes hergestellt wird, ist die Versorgungsspannung der Optiken mithilfe von DIP1 wählen (7.4 Beschreibung der Karte Gehäuse, Seite 17).

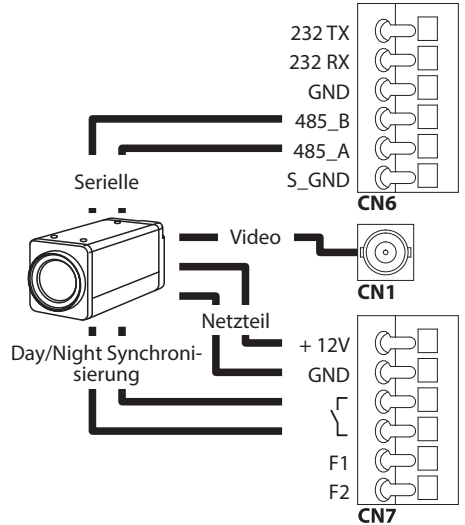
EINSTELLUNG DER VERSORGUNGSSPANNUNG DER MOTOREN DER OPTIKEN		
SW1	SW2	Spannung
OFF	OFF	15Vdc
ON	OFF	12Vdc
OFF	ON	9Vdc
ON	ON	6Vdc

Tab. 3

8 Installation

! Unter keinen Umständen dürfen **Veränderungen oder Anschlüsse vorgenommen werden, die in diesem Handbuch nicht genannt sind. Die Missachtung der Angaben, die das Handbuch zu den Anschlüssen macht, kann die Sicherheit von Personen und die Sicherheit der Anlage stark gefährden.**

! Die **Vorverkabelungen des Produktes dürfen nicht verändert werden. Die Missachtung dieses Verbotes kann die Sicherheit des Personals und der Anlage stark gefährden und führt sie zum Verlust der Gewährleistungsrechte.**

i Falls das **Scheibenreinigungsset** verwendet wird, muss die Halterung für die Düse vor der Positionierung des Schwenk-Neige-Kopfes und der Kabel installiert werden. Weitere Informationen können dem Handbuch des Bausatzes entnommen werden.



Abb. 21

i Im Innern der unteren Haube befindet sich ein Beutelchen, das der Bildung von Feuchtigkeit in der Basis und an den Anschlussplatinen entgegenwirkt. Den Beutel vor der Installation entfernen.

8.1 Anschließen der Kabel an die Basis

Die Kabel in den Kabelschellen einführen, während die Basis etwa 20cm von der Halterung entfernt gehalten wird. Die Kabelverschraubungen festziehen. Alle Kabelverschraubungen sind für Kabel mit einem Durchmesser von 5mm bis 10mm geeignet.

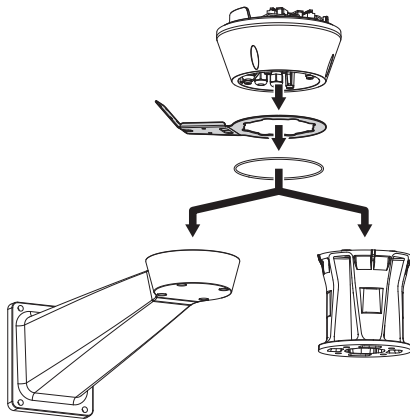

Abb. 22

! Auf die Befestigung achten. Anzugsdrehmoment: 5Nm.

i Für Kabel mit Durchmesser von 3mm bis 7mm die im Lieferumfang enthaltenen Gummidichtungen benutzen.

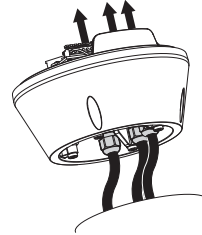

Abb. 23

8.2 Befestigung der Basis an der Halterung

! Verwenden Sie die mit der Basis gelieferten Schrauben und Unterlegscheiben.

Nach der Positionierung der Dichtung (01), die Basis (02) mit den Schrauben (04), den Zahnscheiben (05) und den Ringen für Schrauben (06) an der Halterung (03) befestigen.

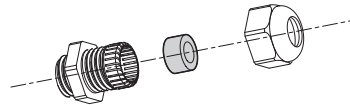

Abb. 24



Abb. 25

Die 3 Markierungen auf der Basis an den Markierungen auf den Halterungen ausrichten, wie in der folgenden Abbildung dargestellt.

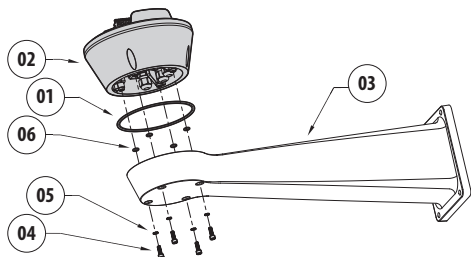

Abb. 26

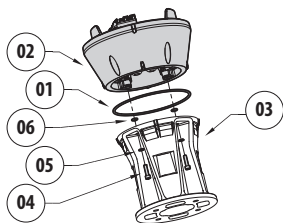
! Auf das Loch der Schrauben ein Gewindegewissungsmittel auftragen (Loctite 243®).

! Auf die Befestigung achten. Anzugsdrehmoment: 6Nm.

Tab. 4

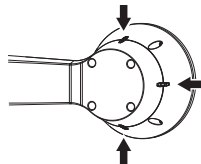
8.3 Beschreibung der Karte Anschlüsse

BESCHREIBUNG DER KARTE ANSCHLÜSSE	
Verbinder/ Komponente	Funktion
J6	Platinenversorgung
J7	Signalkabel
J4	RS-232
F1	Sicherung
F2	Sicherung

Tab. 5 Standardmodell.



Abb. 27 Standardmodell.

BESCHREIBUNG DER KARTE ANSCHLÜSSE	
Verbinder/ Komponente	Funktion
J6	Platinenversorgung
J7	Signalkabel
J4	RS-232
F1	Sicherung
F2	Sicherung

Tab. 6 Version mit LED- Scheinwerfern.

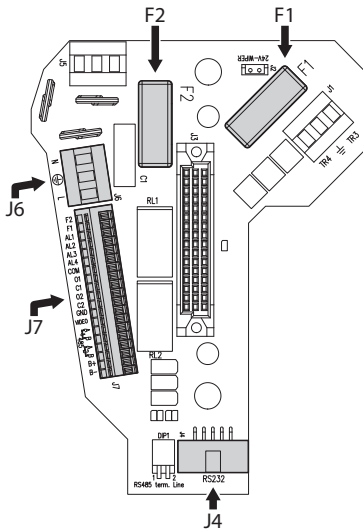

Abb. 28 Version mit LED- Scheinwerfern.

8.4 Anschluss der Stromversorgung

Je nach Version kann die Vorrichtung mit unterschiedlichen Versorgungsspannungen geliefert werden. Der Wert der Versorgungsspannung ist auf dem Kenndatenschildchen des Produktes angegeben. (4.2 Kennzeichnung des Produkts, Seite 10).

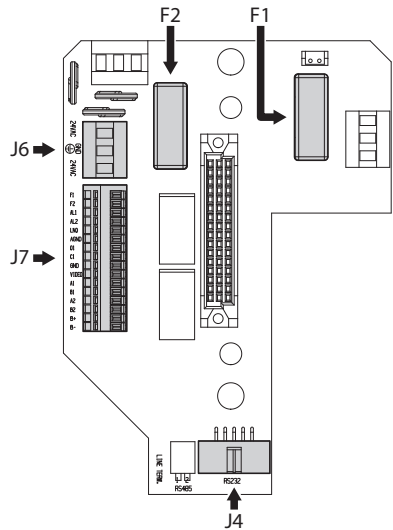

Die elektrischen Anschlüsse nur durchführen, wenn die Stromversorgung abgetrennt und die Trennvorrichtung offen ist.



Im Zuge der Installation ist zu prüfen, ob die Merkmale der von der Anlage bereitgestellten Versorgung mit den erforderlichen Merkmalen der Einrichtung übereinstimmen.



Prüfen Sie, ob die Quelle und das Versorgungskabel sachgerecht bemessen sind.



Das Erdungskabel muss um etwa 10mm länger sein, als die anderen beiden Kabel, um das ungewollte Lösen durch Ziehen des Kabels zu verhindern.



Ferner muss das Versorgungskabel von einer Silikonummantelung (01) überzogen sein, die im Lieferumfang enthalten ist. Die Silikonummantelung soll mit dem zugehörigen Binder fixiert werden (02).



Abb. 29

8.4.1 Anschluss der Stromversorgungsleitung 24Vac

Die Kabel zuschneiden und die unten beschriebenen Anschlüsse vornehmen. Die Versorgungsleitung am Klemmen anschließen: J6.

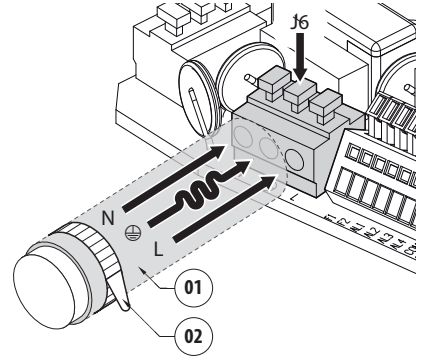

Abb. 30 Standardmodell.



Abb. 31 Version mit LED- Scheinwerfern.

Die Versorgungskabel sind nach der folgenden Tabelle anzuschließen.

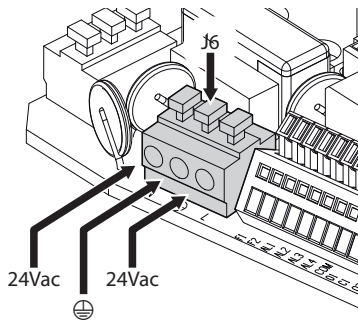
ANSCHLUSS DER STROMVERSORGUNG	
Farbe	Klemmen
Stromversorgung 24Vac	
Vom Installateur festgelegt.	24Vac
Vom Installateur festgelegt.	24Vac
Gelb/Grün	⊕

Tab. 7

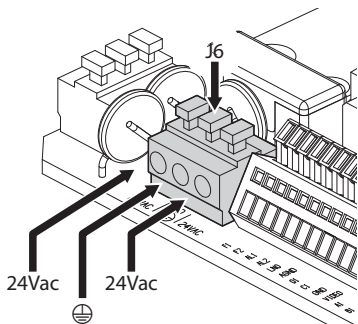
8.4.2 Anschluss der Versorgungsleitung in 120Vac und 230Vac

Die Kabel zuschneiden und die unten beschriebenen Anschlüsse vornehmen. Die Versorgungsleitung am Klemmen anschließen: J6.



Abb. 32 Standardmodell.

Die Versorgungskabel sind nach der folgenden Tabelle anzuschließen.

ANSCHLUSS DER STROMVERSORGUNG	
Farbe	Klemmen
Netzteil 230Vac	
Blau	N (Nullleiter)
Braun	L (Phase)
Gelb/Grün	⊕
Netzteil 120Vac	
Blau	N (Nullleiter)
Braun	L (Phase)
Gelb/Grün	⊕

Tab. 8

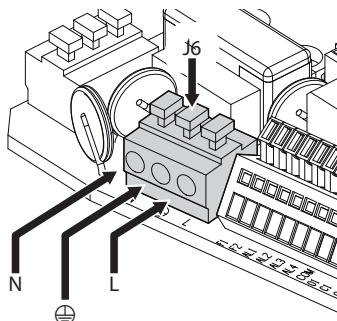
8.5 Anschluss der Signalkabel.



Alle Signalkabel mit einem Kabelbinder müssen zusammengefasst werden.



Abb. 33

8.5.1 Anschluss des Videokabels



ACHTUNG! Zur Senkung der Brandgefahr dürfen nur UL Listed oder CSA zertifizierte Kabel benutzt werden, die mindestens dem Schnitt 0.14mm^2 (26AWG) entsprechen.

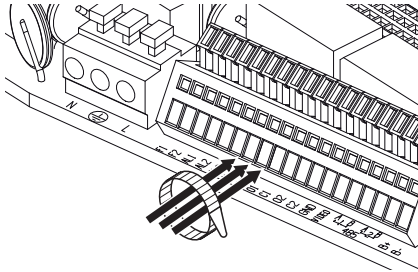

Die Anlage gehört zum Typ CDS (Cable Distribution System). Nicht an Kreisläufe SELV anschließen.



Abschirmung und zentrales Kabel sind mit den Klemmen GND und VIDEO zu verbinden. Die Klemmen können Kabel mit Querschnitten zwischen 0.5mm^2 (20AWG) und 0.08mm^2 (28AWG) aufnehmen.



Abb. 34 Standardmodell.



Abb. 35 Version mit LED- Scheinwerfern.

8.5.2 Anschluss der Telemetrieleitungen

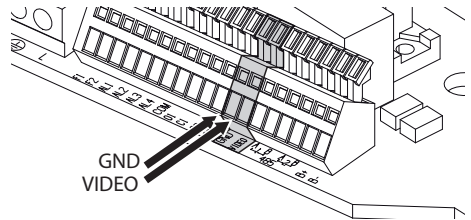

ACHTUNG! Die Anlage gehört zum Typ TNV-1. Nicht an Kreisläufe SELV anschließen.

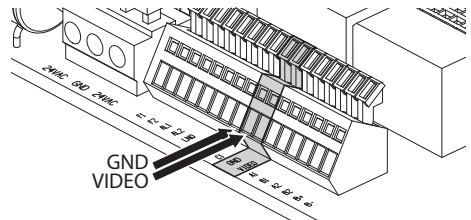

ACHTUNG! Zur Senkung der Brandgefahr dürfen nur UL Listed oder CSA zertifizierte Kabel benutzt werden, die mindestens dem Schnitt 0.14mm² (26AWG) entsprechen.

Das Produkt sieht zwei serielle Übertragungsleitungen RS-485 und eine serielle Leitung RS-232 vor (nur für Firmware-Aktualisierung).

Die seriellen Leitungen können in verschiedenen Arten nach Stellung der Dipschalter 10 und 9 des Wählschalters Seriell und Adresse konfiguriert werden (8.14.4.2 Die Leitungen der seriellen Datenübertragung konfigurieren, Seite 35).

Leitungen für die serielle Datenübertragung RS-485



Abb. 36 RS-485. Standardmodell.



Abb. 37 RS-485. Version mit LED- Scheinwerfern.

ANSCHLUSS DER TELEMETRIELEITUNGEN

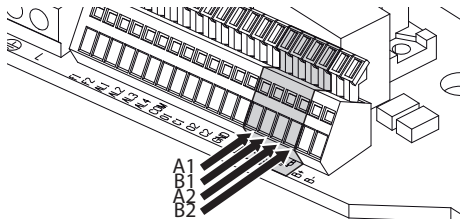
Klemmen	Beschreibung
A1-B1	Linie RS-485 (1)
A2-B2	Linie RS-485 (2)

Tab. 9

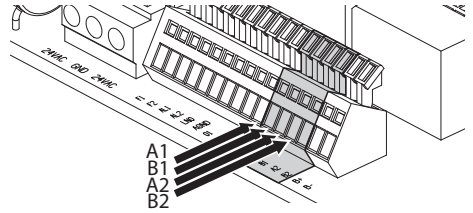
Serielle Leitung für die Datenübertragung RS-232



Abb. 38 RS-232.

8.5.3 Anschluss der Alarmeingänge, der Dämmerungsschalter und der Relais



ACHTUNG! Die Anlage gehört zum Typ TNV-1. Nicht an Kreisläufe SELV anschließen.

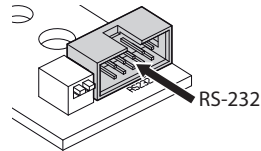

ACHTUNG! Zur Senkung der Brandgefahr dürfen nur UL Listed oder CSA zertifizierte Kabel benutzt werden, die mindestens dem Schnitt 0.14mm² (26AWG) entsprechen.

Standardmodell



Abb. 39 Alarmeingänge.



Abb. 40 Relais.

ANSCHLUSS DER ALARMEINGÄNGE UND DER RELAIS.

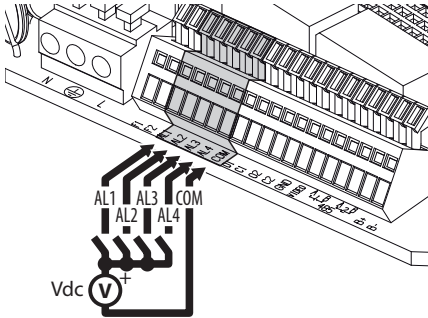
Klemmen	Beschreibung
AL1, AL2, AL3, AL4 e COM	Spannungsgesteuerte Alarmeingänge, bezogen auf gemeinsame Klemme COM
F1-F2	Reserviert für zukünftige Verwendungen
O1-C1 e O2-C2	Potentialfreie Ausgangskontakte, die durch Alarm oder Benutzerbefehl ansprechbar sind

Tab. 10 Standardmodell.

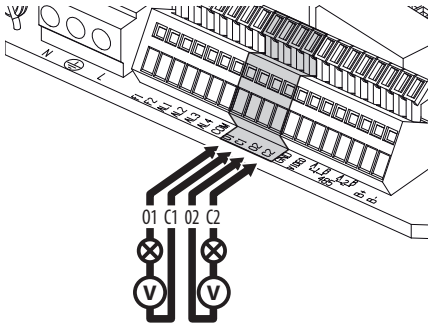
Version mit LED- Scheinwerfern



Abb. 41 Alarmeingänge und Dämmerungsschalter.



Abb. 42 Relais.

ANSCHLUSS DER ALARMEINGÄNGE, DER DÄMMERUNGSSCHALTER UND DER RELAIS

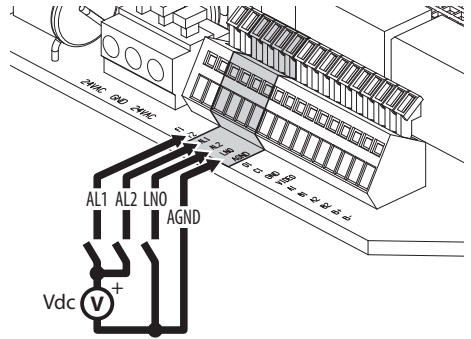
Klemmen	Beschreibung
AL1, AL2 e AGND	Spannungsgesteuerte Alarmeingänge, bezogen auf gemeinsame Klemme AGND.
F1-F2	Reserviert für zukünftige Verwendungen
LNO e AGND	Dämmerungsschalter (potenzialfreier Kontakt)
O1-C1	Potentialfreie Ausgangskontakte, die durch Alarm oder Benutzerbefehl ansprechbar sind

Tab. 11 Version mit LED- Scheinwerfern.

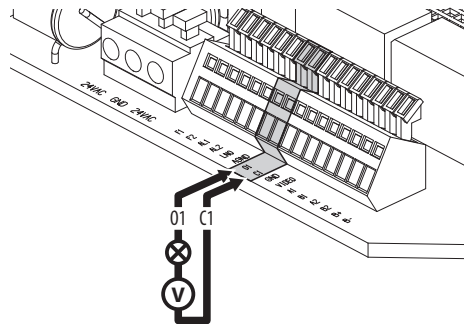
8.6 Befestigung des oberen Körpers

Den oberen Körper (01) mit den Spannschrauben (03) und Dichtungen (04) an der Basis (02) befestigen. Prüfen Sie, ob die Dichtung (05) der Basis vorhanden und in einwandfreiem Zustand ist.

**⚠ Auf die Befestigung achten.
Anzugsdrehmoment: 4Nm.**



Abb. 43



Abb. 44

i Es gibt nur eine Verankerungsposition zwischen der Basis und dem oberen Körper. Die Seitenvorsprünge für eine korrekte Positionierung ausrichten.

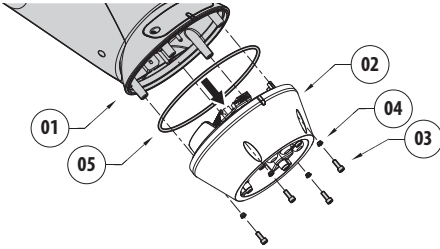
8.7 Aufbau der Gegengewichte

Die Gegengewichte mit den Schrauben und den Unterlegscheiben aus dem Lieferumfang am Gehäuse befestigen.

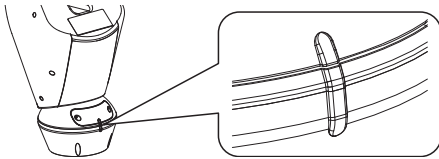

Abb. 45

⚠ Auf das Loch der Schrauben ein Gewindesicherungsmittel auftragen (Loctite 243®).

**⚠ Auf die Befestigung achten.
Anzugsdrehmoment: 16Nm.**

8.8 Montage der Scheinwerfer mit LED

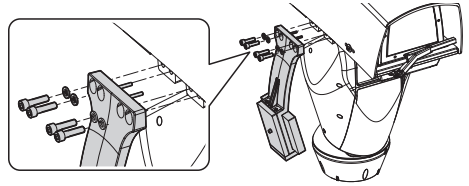

Aus funktionstechnischen Gründen müssen stets beide Scheinwerfer zusammen montiert werden.



Am Schwenk-Neige-Kopf dürfen nur Scheinwerfer von VIDEOTEC installiert werden.

8.8.1 Entfernen der Gegengewichte.

Die Schrauben lösen und die externen Gegengewichte entfernen.



Abb. 46

8.8.2 Montage des Scheinwerfers auf den Bügel

Die vorderen Bohrungen am Bügel des Gegengewichtes bestimmen.

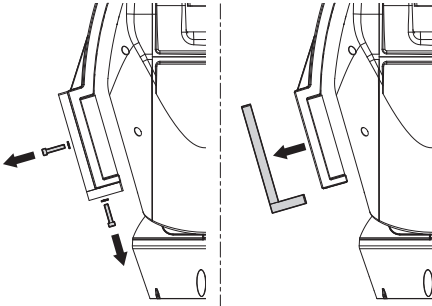

Abb. 47

Befestigungen des Scheinwerfers (01) an denen des Bügels (02) anbringen.

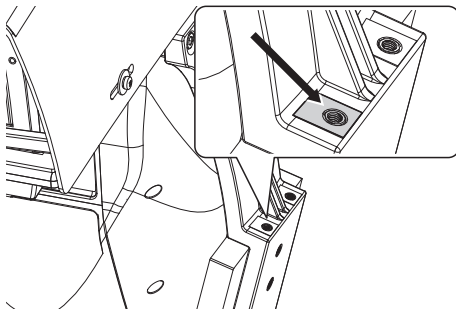

Abb. 48

Die zuvor demontierten Schrauben und Unterlegescheiben wieder festziehen.



Abb. 49

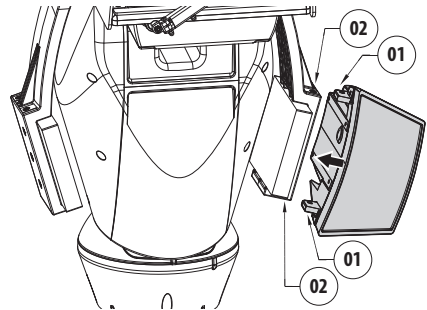

**Auf die Befestigung achten.
Anzugsdrehmoment: 6Nm.**

8.9 Anschluss der LED-Scheinwerfer

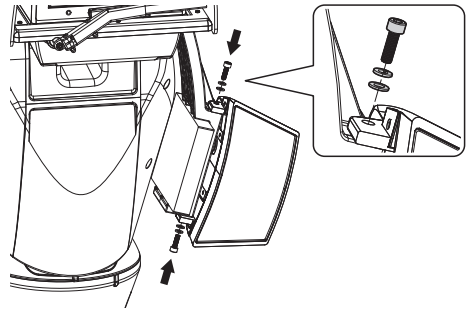
Die 2 Kappen M12 entfernen. Die 2 Kabelschellen und ihren jeweiligen mitgelieferten O-Ring festschrauben.



Abb. 50

! Damit die Sicherheit und die gute Funktion der Einheit nicht beeinträchtigt wird, keinen Kabelüberschuss lassen.

Abb. 51

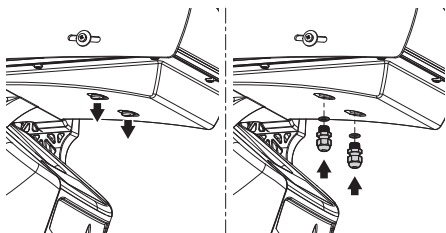

Abb. 52

Die Kabel so anschließen, wie in der Abbildung gezeigt.

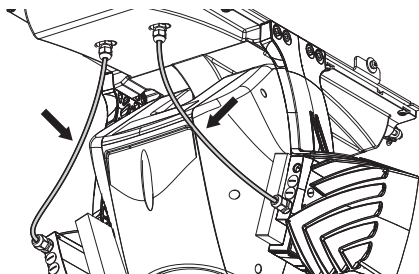

Abb. 53

ANSCHLUSS DER LED-SCHWEINWERFER			
Rechter Scheinwerfer		Linker Scheinwerfer	
Bezug auf die Karte	Kabelfarbe	Bezug auf die Karte	Kabelfarbe
WH	Weiß	WH	Weiß
BK	Schwarz	BK	Schwarz
A1	Grün	A2	Grün
B1	Rot	B2	Rot

Tab. 12

8.10 Anschluss für die Synchronisierung der Kameras mit den LED-Scheinwerfern

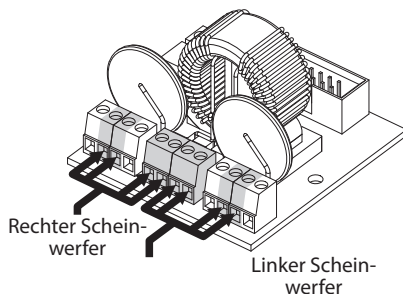
ZFI-Kameras mit IR-Filter: Den Eingang für die Videoumschaltung zwischen den Kamerabetriebsarten Day/Night mit dem Anschluss Night Mode (potenzialfreier Kontakt) verbinden, wie in der Abbildung dargestellt.



Abb. 54

8.11 Trockenmittelbeutel

Die Beutelchen (01) aus der Klarsichtverpackung entnehmen, durch Umknicken trennen und an den beiden abgebildeten Stellen einfügen. Die Beutelchen mit den beigefügten Plättchen (02) und Schrauben (03) fixieren.

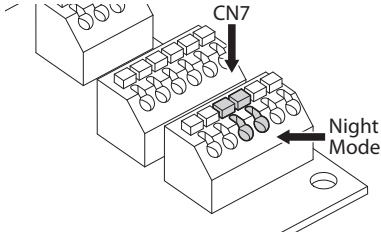

Abb. 55

8.12 Einstellung und Aktivierungsarten der LED-Scheinwerfer

Nach der Regelung synchronisiert und steuert der linke Scheinwerfer (MASTER) den rechten Scheinwerfer (SLAVE).

Der Dämmerungsschalter ermittelt das Licht in der Umgebung und kontrolliert das Ein- und Ausschalten der Scheinwerfer, wenn die Helligkeit das vom Benutzer eingestellte Niveau erreicht hat.

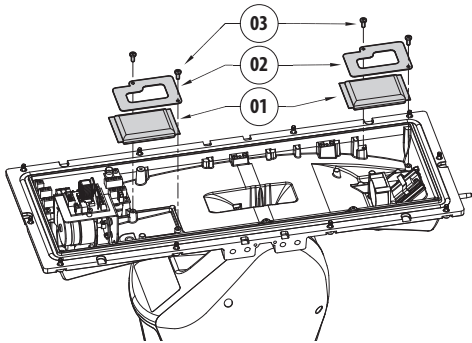
Ein Signal für die Umschaltung Day/Night wird beim Einschalten der LED- Scheinwerfer an die Videokamera gesendet. (8.10 Anschluss für die Synchronisierung der Kameras mit den LED-Scheinwerfern, Seite 30).

8.12.1 Beschreibung des LED-Scheinwerfers



Um die Sicherheit und die Funktion des Beleuchters nicht zu beeinträchtigen, soll der durchsichtige Schrauben des Dämmerungssensors nicht entfernt werden.

- **Dämmerungssensor:** Erfasst den Helligkeitsgrad.
- **Kabel:** Versorgung und Steuerung.
- **Regler der Einschaltung-Grenze:** Das Potenziometer regelt den Empfindlichkeitsgrad für die Einschaltung des Scheinwerfers.
- **Regler der Infrarot- Stärke:** Das Potenziometer regelt die Leistung des Scheinwerfers.



Abb. 56

8.12.2 Aktivierung der LED-Scheinwerfer durch einen externen Dämmerungsschalter

Die folgenden Arbeitsschritte ausführen:

- Anschluss des Dämmerungsschalters an die Klemmen: LNO/AGND (8.5.3 Anschluss der Alarmeingänge, der Dämmerungsschalter und der Relais, Seite 26).
- Den linken Scheinwerfer einstellen. (MASTER):
 - **Einschaltsschwelle:** Wert auf Minimum einstellen (8.12.4 Einstellung der Einschaltsschwelle der LED-Scheinwerfer., Seite 32).
 - **Infrarotleistung:** Wert entsprechend dem Bedarf einstellen (8.12.5 Einstellung der Leistung der LED-Scheinwerfer., Seite 32).
- Regelung des rechten Scheinwerfers (SLAVE):
 - **Einschaltsschwelle:** Wert auf Maximum einstellen (8.12.4 Einstellung der Einschaltsschwelle der LED-Scheinwerfer., Seite 32).
 - **Infrarotleistung:** Wert auf Minimum einstellen (8.12.5 Einstellung der Leistung der LED-Scheinwerfer., Seite 32).
- Den Wert Extern dem Menüpunkt Sonde IR des Menüs Parameter ZFI zuordnen. (10.1.5 Menü Parameter ZFI, Seite 42).

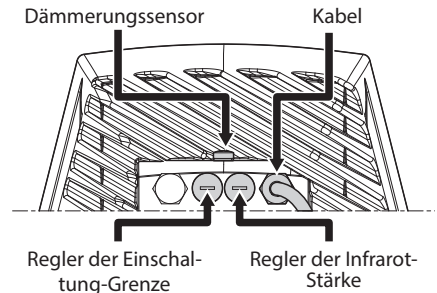
ZFI PARAMETERMENÜ		

1>ZOOM	:	30x
3 IR-SONDE	:	EXTERN
4 ZONENBETITELUNG	:	>
5 ZONENMASKIERUNG	:	>

Abb. 57

8.12.3 Aktivierung der LED-Scheinwerfer durch den integrierten Dämmerungssensor

Die Einheit wird wie folgt mit den LED-Scheinwerfern synchronisiert:

- Den linken Scheinwerfer einstellen. (MASTER):
 - **Einschaltsschwelle:** Wert entsprechend dem Bedarf einstellen (8.12.4 Einstellung der Einschaltsschwelle der LED-Scheinwerfer., Seite 32).
 - **Infrarotleistung:** Wert entsprechend dem Bedarf einstellen (8.12.5 Einstellung der Leistung der LED-Scheinwerfer., Seite 32).
- Regelung des rechten Scheinwerfers (SLAVE):
 - **Einschaltsschwelle:** Wert auf Maximum einstellen (8.12.4 Einstellung der Einschaltsschwelle der LED-Scheinwerfer., Seite 32).
 - **Infrarotleistung:** Wert auf Minimum einstellen (8.12.5 Einstellung der Leistung der LED-Scheinwerfer., Seite 32).
- Den Wert Intern dem Menüpunkt Sonde IR des Menüs Parameter ZFI zuordnen. (10.1.5 Menü Parameter ZFI, Seite 42).

ZFI PARAMETERMENÜ		

1>ZOOM	:	30x
3 IR-SONDE	:	INTERN
4 ZONENBETITELUNG	:	>
5 ZONENMASKIERUNG	:	>

Abb. 58

8.12.4 Einstellung der Einschaltsschwelle der LED-Scheinwerfer.

! Der rechte Scheinwerfer muss immer auf die maximale Helligkeit eingestellt sein.



Abb. 59

Der Scheinwerfer besitzt einen integrierten Dämmerungssensor, der eine automatische Ein- und Ausschaltung unter vorher festgelegten Lichtverhältnissen ermöglicht.

Der Dämmerungssensor wird werkseitig auf eine festgelegte Lichtstärke eingestellt, welche für den Großteil der Installationen geeignet ist (etwa 50lx). Zum Ändern der Einsatzgrenze den an der Rückseite des Scheinwerfers angebrachte Deckel entfernen und die Einstellung vornehmen mittels Schraubenzieher.

Durch Drehen des Trimmers im Uhrzeigersinn im Nachtmodus, wird die Umschaltung vorgezogen (auf einen höheren Helligkeitswert). Durch Drehen des Trimmers gegen den Uhrzeigersinn wird die Umschaltung im Nachtmodus verzögert (auf einen niedrigeren Helligkeitswert).

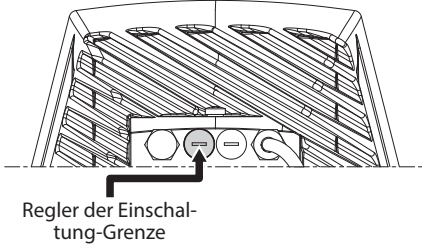

Abb. 60

Die geeigneten Lichtverhältnisse für das Einschalten des Scheinwerfers abwarten. Den Trimmer langsam drehen, bis sich die LED an der Trimmerseite einschaltet. Nachdem die Eingriffsschwelle überschritten wurde (LED eingeschaltet), etwas in die entgegengesetzte Richtung drehen.

! Nach den Einstellungen prüfen, dass der Verschlussdeckel angemessen angezogen ist, um die hermetische Dichtheit des Produkts zu garantieren.

8.12.5 Einstellung der Leistung der LED-Scheinwerfer.

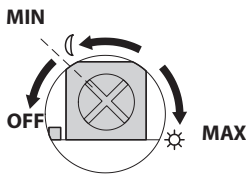
! Der rechte Scheinwerfer muss immer auf die minimale Leistung eingestellt sein.

Der Scheinwerfer wird im Werk zur Erbringung maximaler Leistung eingestellt. Falls es nicht nötig sein sollte, entfernte Objekte zu beleuchten oder wenn das Bild wegen zu hoher Lichtintensität zu stark angestrahlt ist, die Leistung regulieren, sie zu verringern und Energie zu sparen.



Abb. 61

Die hermetische Verschlusskappe abdrehen. Den Trimmer in Uhrzeigersinn drehen, um die Leistung der Infrarot-Scheinwerfer zu erhöhen in in Gegenuhrzeigersinn, um die Leistung zu senken.

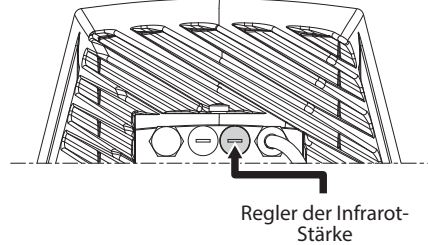

Abb. 62

! Nach den Einstellungen prüfen, dass der Verschlussdeckel angemessen angezogen ist, um die hermetische Dichtheit des Produkts zu garantieren.

8.13 Befestigung des Wischerblattes

Das Wischerblatt auf die Welle des Scheibenwischers setzen.

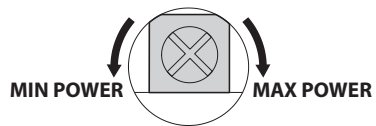
Das Wischerblatt in Ruhestellung bringen.



Abb. 63

Alles zusammen mit der Unterlegscheibe und der Mutter befestigen.

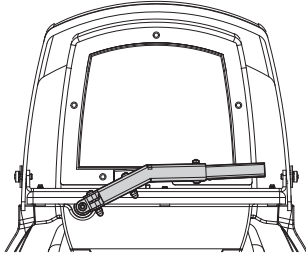

Abb. 64

i Das Wischerblatt ist dann richtig eingestellt, wenn das Blatt in die Ruhestellung zurückkehren kann und dabei an der Korpusplatte anschlägt.

8.14 Hardware Konfiguration

8.14.1 Öffnen der Konfigurationsklappe

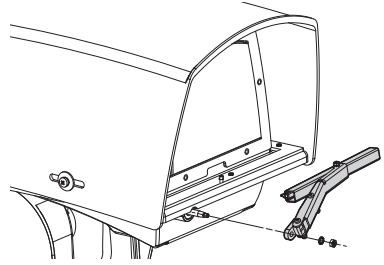
Bevor die Einrichtung mit Strom versorgt wird, muss sie richtig mit den Dipschaltern innerhalb des Konfigurierungsklappchens konfiguriert werden. Das Konfigurierungsklappchen wird durch Entfernen der Schrauben geöffnet, wie in der Abbildung gezeigt.



Abb. 65

Für die DIP-Schalter siehe Abbildung.

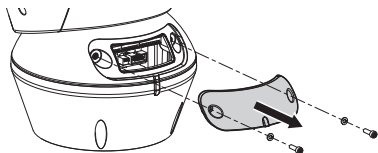

Abb. 66

i Nach Beendigung der Installation und der Verkabelung das Produkt wieder schließen.

8.14.2 Konfiguration der DIP1

i Der nach oben zeigende Kipphebel des Schalters steht für den Wert 1 (ON). Der nach unten zeigende Kipphebel des Dipschalters steht für den Wert 0 (OFF).

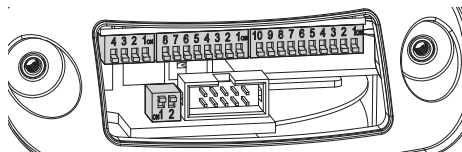
Switch 1 wird für die Aktualisierung der Firmware benutzt.

Die Switch 4, 3 und 2 werden benutzt, um die Kommunikationsgeschwindigkeit der Einrichtung wählen.



Abb. 67

KONFIGURATION DER DIP1					
Beschreibung	SW 4	SW 3	SW 2	SW 1	Baud rate
Einstellung Baudrate	OFF	OFF	OFF	–	300 baud
	ON	OFF	OFF	–	600 baud
	OFF	ON	OFF	–	1200 baud
	ON	ON	OFF	–	2400 baud
	OFF	OFF	ON	–	4800 baud
	ON	OFF	ON	–	9600 baud
	OFF	ON	ON	–	19200 baud
Firmware-Aktualisierung	–	–	–	ON	Programmierung befähigt
	–	–	–	OFF	Programmierung gesperrt

Abb. 68

8.14.3 Konfiguration von DIP2

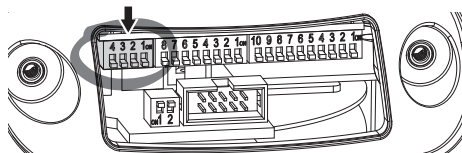
i Der nach oben zeigende Kipphebel des Schalters steht für den Wert 1 (ON). Der nach unten zeigende Kipphebel des Dipschalters steht für den Wert 0 (OFF).

Der Schwenk-Neige-Kopf kann mit den verschiedenen Protokollen gesteuert werden.



Abb. 69

KONFIGURATION VON DIP2								
Protokoll	SW 8	SW 7	SW 6	SW 5	SW 4	SW 3	SW 2	SW 1
PTZ Manager ¹	OFF	OFF	OFF	OFF	OFF	OFF	OFF	OFF
MACRO (VIDEOTEC)	OFF	OFF	OFF	OFF	OFF	ON	ON	ON
PANASONIC	OFF	OFF	OFF	ON	OFF	ON	OFF	OFF
PELCO D	OFF	OFF	OFF	OFF	ON	OFF	OFF	ON
AMERICAN DYNAMICS	OFF	OFF	OFF	OFF	ON	ON	ON	OFF
VISTA	OFF	OFF	OFF	ON	OFF	OFF	ON	ON

Tab. 13 ¹ Konfiguration: MACRO (VIDEOTEC), 115200 baud, Adresse 1. Diese Option benötigt keine Einstellung der DIP-switch (DIP1, DIP3).

Tab. 14

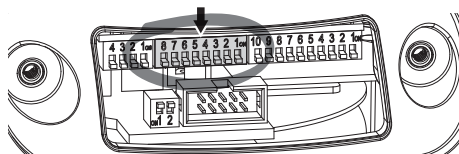
8.14.4 Konfiguration von DIP3

i Der nach oben zeigende Kipphebel des Schalters steht für den Wert 1 (ON). Der nach unten zeigende Kipphebel des Dipschalters steht für den Wert 0 (OFF).



Abb. 70

8.14.4.1 Adressekonfiguration

Die Schalter von 1 bis 8 können für die Konfiguration der Adresse der Einheit verwendet werden (von 1 bis 255).

Die Vorgabe der Adresse erfolgt nach dem Binärcode (A Anhang - Adressentabelle, Seite 66).

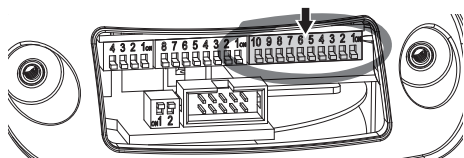
8.14.4.2 Die Leitungen der seriellen Datenübertragung konfigurieren

Das Produkt sieht zwei serielle Übertragungsleitungen RS-485 vor

Die Schalter 10 und 9 können für die Konfiguration der Leitungen für die serielle Datenübertragung verwendet werden.

KONFIGURATION VON DIP3		
Beschreibung	SW 10	SW 9
Ein-Wege-Kommunikation an der Leitung RS-485-1.	OFF	OFF
Kommunikation in full-duplex gemäß Standard RS-422.	OFF	ON
Anschluss mehrerer Vorrichtungen in Kaskade. Das Signal wird von jeder Einheit erzeugt.	ON	OFF
Zwei-Wege-Kommunikation, half-duplex, an der Leitung RS-485-1.	ON	ON

Tab. 15

i Für weitere Infos bitte entsprechendes Kapitel beachten (8.14.6 Montagebeispiel, Seite 36).

8.14.5 Konfiguration von DIP4

i Die Einstellung dieses Dipschalters erfolgt in umgekehrter Reihenfolge wie die vorherige. Der nach oben zeigende Kipphebel des Schalters steht für den Wert 0 (OFF). Der nach unten zeigende Kipphebel des Dipschalters steht für den Wert 1 (ON).

Auf der Platine befinden sich zwei Switches für die Konfiguration der Terminierung (120 Ohm) der seriellen Linien.



Abb. 71

Jede Einheit, die am Leitungsende hängt, muss mit dem zugehörigen Switch mit einem Abschlusswiderstand beschaltet werden, um zu vermeiden, dass entlang der Leitung Reflexionen und Deformationen auftreten.

Die Switch 1 und 2 beschalten die seriellen Leitungen RS-485-1 und RS-485-2 jeweils mit einem Abschlusswiderstand.

KONFIGURATION VON DIP4			
Serielle linie	SW 2	SW 1	Beschreibung
Linie RS-485-1	–	ON	Beendet
	–	OFF	Nicht beendet
Linie RS-485-2	ON	–	Beendet
	OFF	–	Nicht beendet

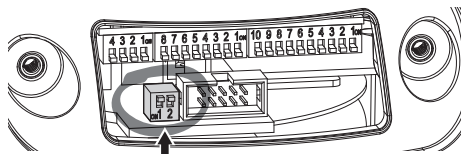
Tab. 16

8.14.6 Montagebeispiel

8.14.6.1 Leitung RS-485 RX

Die Leitung RS-485-1 arbeitet mit den Einstellungen, die mit Hilfe der Dipschalter Adresse, Baud rate und Protokoll vorgegeben werden.

Die serielle Leitung RS-485-2 ist nicht benutzt.



Abb. 72

⚠ ACHTUNG! Die Anlage gehört zum Typ TNV-1. Nicht an Kreisläufe SELV anschließen.

8.14.6.2 Leitung RS-422 (RS-485-1 RX e RS-485-2 TX)

Diese Einstellung gestattet die Full-Duplex-Kommunikation nach dem Standard RS-422. Es werden deshalb die beiden Leitungen RS-485-1 und RS-485-2 verwendet.

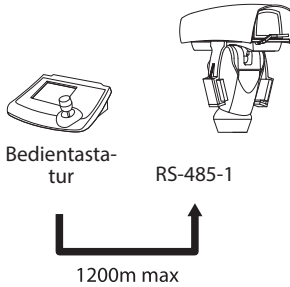

Abb. 73

i Diese Funktion ist nur mit beidseitig gerichteten Protokollen verfügbar (Beispiel: PELCO, AMERICAN DYNAMICS, VIDEOTEC MACRO, etc.).

8.14.6.3 Leitung 1 RS-485 Empfang, Leitung 2 RS-485 Wiederholung

Bei dieser Einstellung können mehrere Einrichtungen kaskadiert angeschlossen werden. Das Signal wird von jeder Einheit regeneriert und ist dadurch über eine erheblich größere Distanz übertragbar.

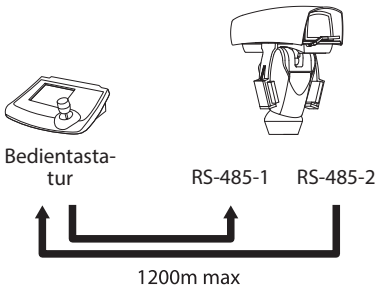

Abb. 74

i Diese Konfiguration kann nur mit Ein-Weg-Protokollen verwendet werden.

8.14.6.4 Leitung RS-485 TX/RX bidirektional

Diese Einstellung gestattet eine beidseitig gerichtete Half-Duplex-Übertragung auf der Leitung RS-485-1.

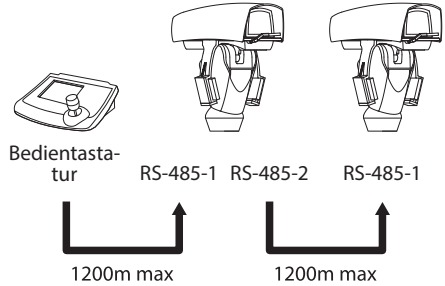
Die serielle Leitung RS-485-2 ist nicht benutzt.







Abb. 75

i Diese Funktion ist nur mit beidseitig gerichteten Protokollen verfügbar (Beispiel: PELCO, AMERICAN DYNAMICS, VIDEOTEC MACRO, etc.).

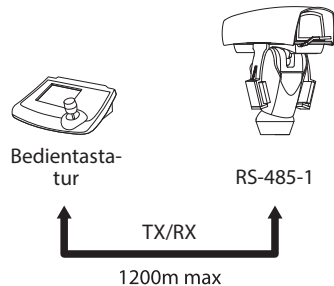
9 Einschaltung

 **Sicherstellen, das die Einheit und die anderen Bauteile der Anlage korrekt geschlossen sind, um den Kontakt mit unter Spannung stehenden Bauteilen zu verhindern.**

 **Im normalen Betrieb kann der Scheinwerfer an der Oberfläche Hohe Temperaturen erreichen. Vermeiden Sie die direkte Berührung und positionieren Sie das Gerät an einem Ort, der für Unbefugte unzugänglich ist. Bevor man sie berührt, muss deshalb die Ausleuchtungseinrichtung abgeschaltet werden und mindestens 10 Minuten lang abkühlen.**

 **Nicht die Nähe der Einrichtung aufsuchen, wenn sie mit Strom gespeist ist. Nur bei abgeschalteter Stromversorgung auf die Vorrichtung einwirken.**

 **Vergewissern Sie sich, dass alle Teile solide und zuverlässig befestigt sind.**

 **Der automatische Vorheizvorgang (De-Ice) könnte immer dann aktiviert werden, wenn das Gerät bei einer Umgebungstemperatur von unter 0°C in Betrieb genommen wird. Dieser Vorgang dient dazu, auch bei niedrigen Temperaturen den einwandfreien Betrieb der Einrichtungen sicherzustellen. Die Dauer liegt je nach Wetterbedingungen (von 60 Minuten bis zu 105 Minuten).**

Für das Einschalten der Einheit die elektrische Versorgung anzulegen.

Die elektrische Versorgung abtrennen, um die Einheit abzuschalten.

9.1 Erstes Einschalten

Beim erstmaligen Einschalten ist es stets zweckmäßig, die korrekte Konfiguration der Einrichtung zu überprüfen.

Vor der Stromversorgung die Schutztür der Dipschalter entfernen und den Hebel des Schalters für Firmware-Update auf ON stellen. (8.14.2 Konfiguration der DIP1, Seite 34).

Die Vorrichtung versorgen. Nach einigen Sekunden kann am Monitor die eingestellte Konfiguration überprüft werden..

Nach Abschluss der Überprüfung die Einrichtung abschalten und den Hebel des Switch für die Aktualisierung der Firmware wieder absenken.

Die Klappe schließen und die Einrichtung wieder speisen.

9.2 Liste der Kontrollen

 **Wenn eine der Kontrollen den Test (ERR) nicht besteht, kontaktieren Sie den technischen Kundendienst. OFF bedeutet, dass der Schwenk-Neige-Kopf nicht mit der genannten Option ausgestattet ist.**

Beim Hochfahren zeigt die Einrichtung die Liste der Kontrollen an, welche sie vor dem Wechsel in den Normalbetrieb durchführen muss.

```

STARTUP
-----
TEST FLASH           : OK
HOMING PROCEDURE    : OK
ZFI SEARCH           : OK
IO EXPANDER          : OFF
IR360 STATE          : OFF
  
```

Abb. 76

10 Konfiguration

10.1 OSM-Schnittstelle (On Screen Menu)

10.1.1 Gebrauch des OSM

Während des normalen Betriebs der Einheit kann OSM für die Auswahl und die Konfiguration der erweiterten Funktionen aktiviert werden.. Für weitere Informationen siehe entsprechendes Kapitel im Handbuch der verwendeten Tastatur. (12.11 Spezialbefehle, Seite 56).

Austritt aus OSM mit Zoom Wide (Zoom-).

i Das Menü konfiguriert sich je nach Modell des Schwenk-Neige-Kopfes dynamisch selbst.

10.1.1.1 Verwendung des Steuerknüppels

Alle Menüvorgänge werden mit dem Steuerknüppel veranlasst.



Abb. 77 Pan und tilt.



Abb. 78 Zoom Wide und Zoom Tele.

i Falls Bedientastaturen mit Zweiachsen-Joystick verwendet werden, die Tasten Zoom Wide und Zoom Tele verwenden, um die Befehle Beenden und Bestätigen zu senden.

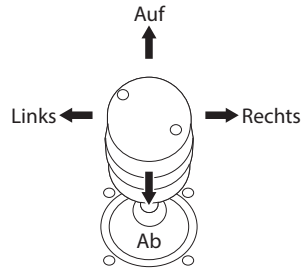
10.1.1.2 Das Bewegen innerhalb der Menüs

Jeder OSM-Bildschirm weist eine Liste mit Parametern oder Untermenüs auf, die vom Bediener angewählt werden können. Um die verschiedenen Parameter durchzublätern, den Cursor mit dem Joystick (rauf und runter) bewegen.

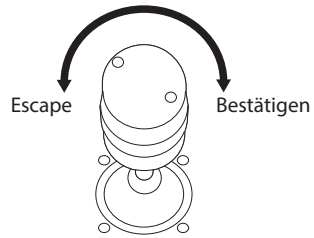

Abb. 79

Das Symbol > am Zeilenende weist darauf hin, dass ein spezielles Untermenü vorhanden ist. Um es aufzurufen, reicht es aus, die entsprechende Menüoption zu bestätigen. Zum Verlassen des Untermenüs die Funktion Escape (Zoom Wide) benutzen.

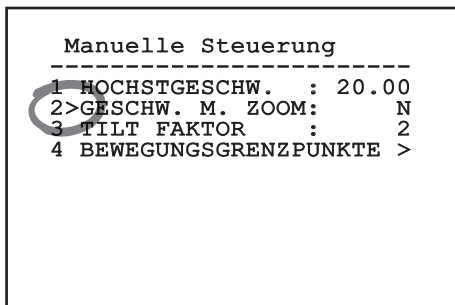

Abb. 80

10.1.1.3 Ändern von Parametern

Den Cursor auf den zu ändernden Parameter bewegen und bestätigen. Das Feld beginnt zu blinken als Zeichen dafür, dass es geändert wird. Mithilfe des Joysticks (Bewegung nach oben und unten) werden die Wahlmöglichkeiten angezeigt.

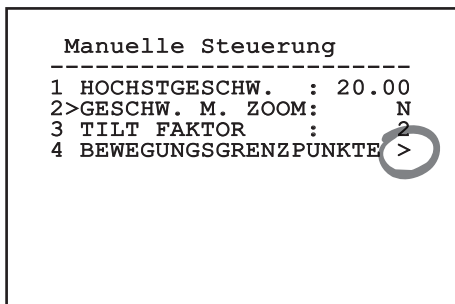

Abb. 81

Nach der Bestimmung der gewünschten Option bestätigen.

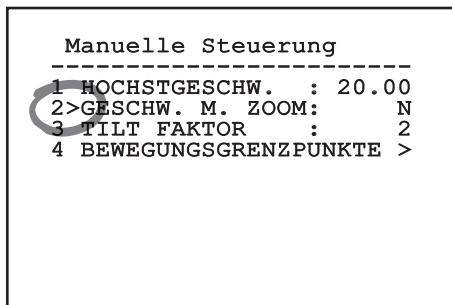

Abb. 82

Das Feld hört auf zu blinken, um die Präferenz zu bestätigen.

10.1.1.4 Ändern der Zahlenfelder

Den Cursor auf den zu ändernden Parameter bewegen und bestätigen.

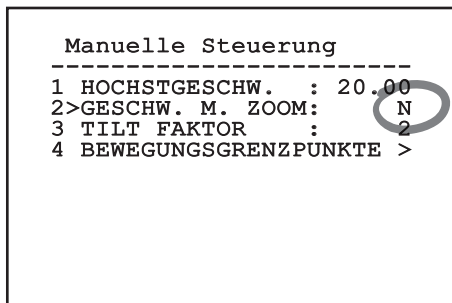
```

PRESET ANDERN
-----
1 NR.      :      1
2 ENAB.   :      N
3>PAN     : +  0.00
4 TILT    : - 40.00
5 SPEED   :  20.00
6 PAUSE   :      5
7 TEXT    : PRESET 001
8 WECHSELN ZU PRESET?
  
```

Abb. 83

Die erste Ziffer des gerade geänderten Zahlenfeldes blinkt und in der unteren Zeile wird gezeigt, welche Werte für das Feld zulässig sind. Das Feld mit dem Steuerknüppel aufsuchen (rechts und links) und das Vorzeichen oder den Zahlenwert ändern (auf und ab).

```

PRESET ANDERN
-----
1 NR.      :      1
2 ENAB.   :      N
3>PAN     : +000.00
4 TILT    : - 40.00
5 SPEED   :  20.00
6 PAUSE   :      5
7 TEXT    : PRESET 001
8 WECHSELN ZU PRESET?

min:-180.00 max:+179.99
  
```

Abb. 84

Die vorgenommene Änderung bestätigen. Der Cursor bewegt sich nach links und die bearbeitete Ziffer hört auf zu blinken. Das Feld wird zwangsweise auf den zulässigen Mindest- oder Höchstwert gebracht, wenn versucht wird, einen nicht vorgesehenen Wert einzugeben.

10.1.1.5 Ändern von Texten

Den Cursor auf den zu ändernden Parameter bewegen und bestätigen.

```

ZONE ANDERN
-----
1 NR      :      1
2 START  :+  0.00
3 STOP   :+  0.00
4>TEXT   :TXT AREA1
  
```

Abb. 85

Es erscheint die Bildschirmseite für die Bearbeitung des Textes. Das Pfeilsymbol positioniert sich unter dem Zeichen, das verändert werden soll, während der Cursor > sich links neben dem ausgewählten Zeichen positioniert.

```

EDIT TEXT: AREA
-----
Text: TEXT AREA1
      ↑
>A B C D E F G   ERASE
  H I J K L M N   SAVE
   O P Q R S T U   EXIT
  V W X Y Z 0 1   abc
   2 3 4 5 6 7 8
  9 : ; . , ? !
   \ + - * / = `
  < > SPACE ← →
  
```

Abb. 86

Es ist möglich, mit dem Joystick innerhalb des Menüs zu navigieren.



Abb. 87

Mit dem Befehl Bestätigen (Zoom Tele) wird das gewünschte Zeichen eingefügt.

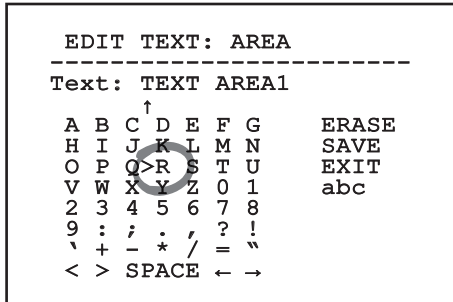

Abb. 88

Verwenden Sie:

- **ERASE:** Die gesamte Textzeichenfolge löschen.
- **SAVE:** Speichern des neuen Textes vor dem Austritt aus dem Menü.
- **EXIT:** Austritt aus dem Menü.
- **abc:** Anzeige der Kleinbuchstaben.

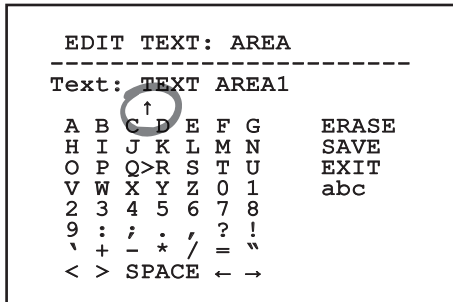

Abb. 89

Das Menü kann auch mit Zoom Wide verlassen werden.

10.1.2 Konfiguration über OSM

Im Folgenden werden die Bildschirmseiten zur Konfiguration des Produkts beschrieben.

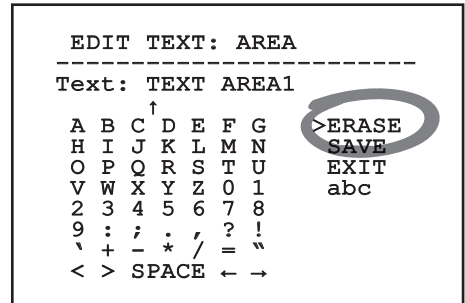
10.1.3 Hauptmenü

Vom Hauptmenü aus kann die Konfigurierung der Einrichtung aufgerufen werden.



Abb. 90

Das Menü konfiguriert sich je nach Modell des Schwenk-Neige-Kopfes dynamisch selbst.

10.1.4 Menü Sprachwahl

Mit dem Menü kann die gewünschte Sprache ausgewählt werden.

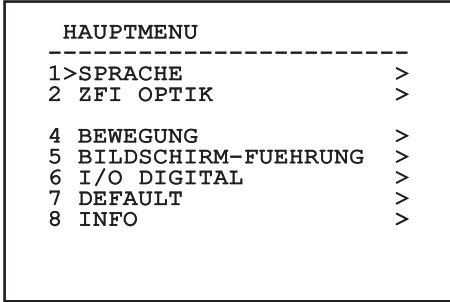

Abb. 91

10.1.5 Menü Parameter ZFI

- Zoom:** Einstellbar ist die maximale Vergrößerungszahl, welche die motorisierte Optik leisten kann.
- Gemeinsamer Draht:** Wird diese Option aktiviert, werden die motorisierten Optiken mit gemeinsamem Draht gesteuert, andernfalls die Optiken mit Polaritätsumkehr.
- IR-Sonde:** Meldet die Präsenz eines Dämmerungsschalters für die Steuerung Day/Night der motorisierten Optik. Es stehen drei Optionen zur Verfügung:
 - Off: Umschaltung Day/Night nicht aktiviert.
 - Interne: Der Dämmerungsschalter für die Umschaltung Day/Night befindet sich im Inneren der Scheinwerfer.
 - Extern: Der Dämmerungsschalter für die Umschaltung Day/Night muss an der Klemme LNO angeschlossen werden.
- Zonenbetitelung:** Gestattet den Aufruf des Untermenüs für die Zonenbetitelung.
- Zonenmaskierung:** Gestattet den Aufruf des Untermenüs für die Zonenmaskierung.
- Gehäuse Seriell:** Ermöglicht den Aufruf des Untermenüs für die Steuerung des seriellen Gehäuseports.
- Polarität:** Ermöglicht den Aufruf des Untermenüs für die Polaritätssteuerung der Motoren Zoom, Focus und Iris.

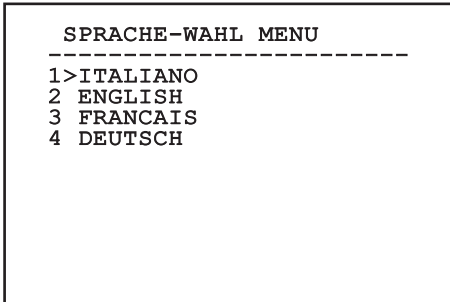

Abb. 92

10.1.5.1 Menü Zonenbetitelung

Diese Funktion gestattet die Festlegung von bis zu acht Zonen (verschiedener Größe), die sich betiteln lassen.

Ermöglicht die Konfiguration folgender Parameter:

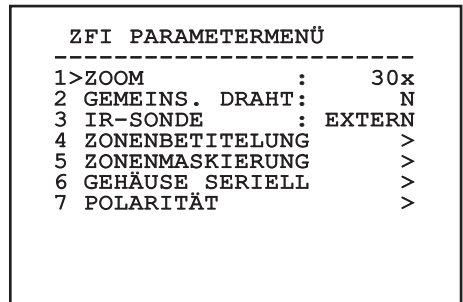
Nummer: Auswahl der zu ändernden Zone.

Befähigung: Aktiviert die Bildschirmanzeige der Meldung, welche der erreichten Zone zugeordnet ist.

Start: Anfangsposition der Zone.

Stop: Endposition der Zone.

Text: Änderung des Textes, der angezeigt wird, wenn man sich innerhalb des Bereiches bewegt.

ZONENBETITELUNG			

1	>NR.	:	1
2	ENAB.	:	N
3	START:	+	0.00
4	STOP	:	+ 0.00
5	TEXT	:	ZONE 1

Abb. 93

Beispiel: Um die Betitelung der Zone 1 zu aktivieren, wenn sich die Vorrichtung zwischen +15° und +45° befindet, ist folgendermaßen vorzugehen:

- Die Zonenbetitelung aktivieren, indem man unter Aktivierung im Menü Zonenbetitelung ein J vorgibt.
- Auswahl von 1 als Wert des Parameters Nr.
- Für den Parameter Start den Wert +015.00 vorgeben.
- Für den Parameter Stop den Wert +045.00 setzen.
- Falls gewünscht, den angezeigten Text mit der Option Text bearbeiten.

i Wenn man die Parameter Start und Stop aus dem Menü auf den Wert Null setzt, wird die Anzeige der Betitelung deaktiviert. Bei Überlagerung mehrerer Bereiche ist die niedrigere Nummer ausschlaggebend.

i Die Bereiche definieren, dazu im Uhrzeigersinn bewegen, siehe Abbildung.



Abb. 94

10.1.5.2 Menü Zonenmaskierung

Diese Funktion gestattet die Festlegung von bis zu acht Masken (verschiedener Größe), die sich betiteln lassen.

1. **Numer:** Auswahl der zu ändernden Zone.
2. **Enabling:** Aktiviert die Maskierung der erreichten Zone.
3. **Start:** Anfangsposition der Zone.
4. **Stop:** Vorgabe der Position, an der die Maske endet.
5. **Text:** Änderung des Textes, der bei aktivierter Maske angezeigt wird.

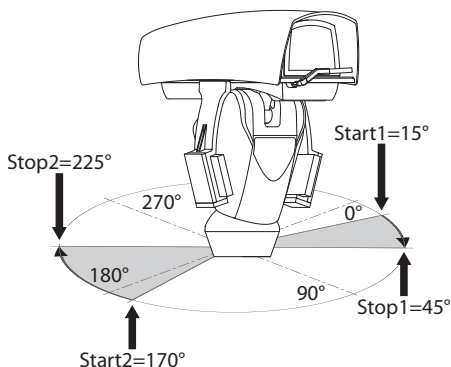
ZONENMASKIERUNG		

1 >NR	:	1
2 ENAB.	:	N
3 START	:	+ 0.00
4 STOP	:	+ 0.00
5 TEXT	:	MASK 1

Abb. 95

Beispiel: Zur Aktivierung der Maskierung von Zone 1 wenn sich die Vorrichtung zwischen $+15^\circ$ und $+45^\circ$ befindet wie folgt vorgehen:

- Auswahl von 1 als Wert des Parameters Nr.
- Die Zonenmaskierung aktivieren, indem unter Aktivierung J gewählt wird.
- Für den Parameter Start den Wert $+015.00$ vorgeben.
- Für den Parameter Stop den Wert $+045.00$ setzen.
- Falls gewünscht, den angezeigten Text mit der Option Text bearbeiten.

i Setzt man die Werte Start und Stop des Menüs auf Null, ist die Maskierung deaktiviert. Wenn sich mehrere Masken überlagern, hat die Maske mit der niedrigeren Nummer den Vorrang.

i Die Masken definieren, dazu im Uhrzeigersinn bewegen, siehe Abbildung.



Abb. 96

10.1.6 Menü Gehäuse seriell

i Nachdem das OSM der Kamera verlassen worden ist, die Taste Iris Close drücken, um zum OSM des Schwenk-Neige-Kopfes zurückzukehren.

i Um die Überlagerung des OSM von Kamera mit dem OSM des Schwenk-Neige-Kopfes zu vermeiden, muss der Konfigurationsmodus der Kamera verlassen werden, bevor die Taste Iris Close gedrückt wird.

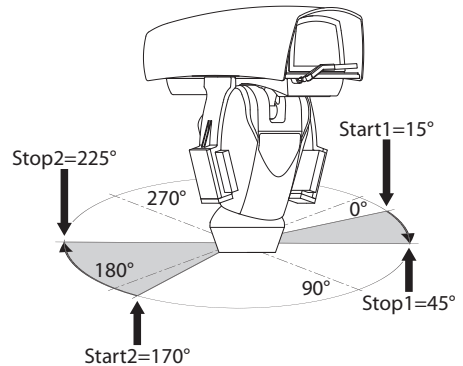
1. **Protokoll:** Ermöglicht die Auswahl des in der seriellen Port des Gehäuses verwendeten Protokolls.
2. **Baudrate:** Ermöglicht die Auswahl der in der seriellen Port des Gehäuses verwendeten Baudrate.
3. **Bef. Enter:** Ersetzt den Befehl Bestätigen per Joystick durch einen benutzerdefinierten.
4. **Bef. Esc:** Ersetzt den Befehl Beenden per Joystick durch einen benutzerdefinierten.
5. **OSM Kamera Aktivieren:** Gestattet den Eintritt in den Modus zur Konfiguration der Kamera.

```

GEHÄUSE SERIELL
-----
1>PROTOKOLL :      KEINES
2 BAUDRATE  :      9600
3 BEF. ENTER: IRIS CLOSE
4 BEF. ESC  : IRIS OPEN
5 OSM KAMERA AKTIVIEREN>

```

Abb. 97

10.1.7 Menü Polarität

Ermöglicht die Konfiguration folgender Parameter:

1. **Zoom:** Ermöglicht die Auswahl der Polarität der Motordrehung des Zooms der Optik.
2. **Focus:** Ermöglicht die Auswahl der Polarität der Motordrehung des Focus der Optik.
3. **Iris:** Ermöglicht die Auswahl der Polarität der Motordrehung der Iris der Optik.

```

POLARITÄT
-----
1>ZOOM :      POSITIV
2 FOCUS:      POSITIV
3 IRIS  :      POSITIV

```

Abb. 98

10.1.8 Menü Bewegung

1. **Offset Pan:** Der Schwenk-Neige-Kopf hat eine Position von 0°, die mechanisch definiert ist. Die Funktion Offset Pan ermöglicht es, auf Softwareebene eine andere Position als 0° festzulegen.
2. **Manuelle Steuerung:** Ermöglicht den Zugriff auf die Untermenüs mit den Parametern, welche den manuellen Bewegungen der Einrichtung zugeordnet sind.
3. **Preset:** Ermöglicht den Zugriff auf die Untermenüs, welche die Änderung der Presetwerte ermöglichen.
4. **Patrol:** Ermöglicht den Aufruf der Untermenüs, welche die Änderung der Patrolwerte ermöglichen.
5. **Autopan:** Ermöglicht den Aufruf der Untermenüs für die Änderung der Autopanwerte.
6. **Bewegungsanforderung:** Ermöglicht den Aufruf des Untermenüs für die automatische Bewegungsanforderung.

BEWEGUNG

```
-----
1>OFFSET PAN:      + 20.00
2 MANUELLE STEUERUNG >
3 PRESET          >
4 PATROL          >
5 AUTOPAN         >
6 BEWEGUNGSANFORDERUNG >
```

Abb. 99

10.1.8.1 Menü Handsteuerung

1. **Höchstgeschwindigkeit:** Auswahl der maximalen manuellen Geschwindigkeit.
2. **Geschwindigkeit Mit Zoom:** Bei Aktivierung dieses Parameters wird die Geschwindigkeit für Pan und Tilt automatisch in Abhängigkeit vom Zoomfaktor reduziert.
3. **Tilt-Faktor:** Auswahl des Verkleinerungsfaktors der manuellen Geschwindigkeit der Achse tilt.
4. **Bewegungsgrenzwerte:** Zugriff auf das Menü Grenzwerte.

Manuelle Steuerung

```
-----
1>HOCHSTGESCHW.   : 20.00
2 GESCHW. M. ZOOM:   N
3 TILT FAKTOR     :    2
4 BEWEGUNGSGRENZPUNKTE >
```

Abb. 100

10.1.8.2 Menü Handsteuerung (Grenzpunkte)

Ermöglicht die Konfiguration folgender Parameter:

1. **Grenzkpunkte Pan:** Aktiviert die Grenzpunkte für die Funktion Pan (Kameraschwenk).
2. **Beginn Pan:** Vorgabe der Grenzposition zu Beginn des Kameraschwenks (Pan).
3. **Ende Pan:** Vorgabe der Grenzposition am Ende des Kameraschwenks (Pan).
4. **Beginn Tilt:** Vorgabe der Grenzposition zu Beginn der Kameraneigung (Tilt)
5. **Ende Tilt:** Vorgabe der Grenzposition am Ende der Kameraneigung (Tilt).

GRENZPUNKTE			

1>PAN	:		N
2 BEGINN PAN	:	+ 0.00	
3 ENDE PAN	:	+ 0.00	
4 BEGINN TILT	:	+ 0.00	
5 ENDE TILT	:	+ 0.00	

Abb. 101

Das Menü konfiguriert sich dynamisch in Abhängigkeit von der gewählten Einstellung und weist die Parameter aus, die verändert werden können.

10.1.8.3 Menü Preset

1. **Preset Ändern:** Für den Zugriff auf das Menü Änderung Preset.
2. **Utility Preset:** Für den Zugriff auf das Menü Utility Preset.

PRESET	

1>PRESET ANDERN	>
2 UTILITY PRESET	>

Abb. 102

10.1.8.4 Menü Preset (Preset Ändern)

Ermöglicht die Konfiguration folgender Parameter:

1. **Nummer:** Dies ist die Nummer des zu ändernden Preset.
2. **Befähigung:** Zum Einschalten des Preset.
3. **Pan:** Pan-Position in Grad.
4. **Tilt:** Tilt-Position in Grad.
5. **Geschwindigkeit:** Geschwindigkeit, um die Position zu erreichen, wenn der Preset von den Funktionen Patrol und Autopan aufgerufen wird.
6. **Pause:** Wartezeit in Sekunden vor Beginn der nachfolgenden Patrol- Bewegung.
7. **Text:** Der angezeigte Text bei Erreichen der Presetposition.
8. **Wechseln Zu Preset?:** Der Schwenk-Neige-Kopf wird angewiesen, zur ausgewählten Position Preset zu wechseln.
9. **Bewegungen Aktivieren:** Ermöglicht die Auswahl eines neuen Bildausschnittes.

PRESET ANDERN	

1>NR. :	1
2 ENAB. :	N
3 PAN :	+ 0.00
4 TILT :	- 40.00
5 SPEED :	20.00
6 PAUSE :	5
7 TEXT :	PRESET 001
8 WECHSELN ZU PRESET?	
9 BEWEGUNGEN AKT.	>

Abb. 103

Vom Menü aus lassen sich die Presetpositionen direkt speichern, wenn man den Befehl Iris Close übermittelt, der die Bewegungen des Schwenk-Neige-Kopfes aktiviert.

10.1.8.5 Menü Preset (Utility Preset)

Ermöglicht die Konfiguration folgender Parameter:

1. **Scan Geschwindigkeit:** Geschwindigkeit, die dazu verwendet wird, um die Preset-Position nach dem Empfang eines Befehls Scan zu erreichen.
2. **Standardgeschwindigkeit:** Preset-Standardgeschwindigkeit Dieser Wert wird von der Funktion Geschw. erzwingen? verwendet, um allen Preset dieselbe Geschwindigkeit zuzuordnen.
3. **Standardpause:** Preset- Standardpausen Dieser Wert wird von der Funktion Pause erzwingen? verwendet, um allen Preset dieselbe Pause zuzuordnen.
4. **Rampenwert:** Die Zeiten für Start und Stopp. Einer höheren Nummer entspricht eine größere Beschleunigung / Abbremsung beim Start/ Stopp.
5. **Geschwindigkeit Setzen?:** Weist allen Vorwahlpositionen (Preset) die Standardgeschwindigkeit zu.
6. **Pause Setzen?:** Weist allen Vorwahlpositionen die Standardpause zu.

```
UTILITY PRESET
-----
1>SCAN GESCHWIND : 20.00
2 STANDARDGESCHW.: 10.00
3 STANDARDPAUSE : 3
4 RAMPENWERT : 12
5 GESCHW. SETZEN?
6 PAUSE SETZEN?
```

Abb. 104

10.1.8.6 Menü Patrol

1. **Erstes Preset:** Erster Preset der Sequenz Patrol.
2. **Letzes Preset:** Letzter Preset der Sequenz Patrol.
3. **Random Modus:** Aktiviert wird die zufällige Ausführung. Die Sequenz wird laufend neu berechnet.

```
PATROL
-----
1>ERSTES PRESET : 1
2 LETZES PRESET : 250
3 RANDOM MODUS : N
```

Abb. 105

10.1.8.7 Menü Autopan

1. **Preset Hin:** Ausgangsposition Autopan.
2. **Preset Zurück:** Endposition Autopan.

```
AUTOPAN
-----
1>PRESET HIN : 1
2 PRESET ZURUCK : 2
```

Abb. 106



Die Geschwindigkeit, um die Preset-Positionen zu erreichen, wird im entsprechenden Kapitel definiert. (10.1.8.4 Menü Preset (Preset Ändern), Seite 47).

10.1.8.8 Menü Bewegungsanforderung

Das Gerät kann so konfiguriert werden, dass nach einer gewissen Zeit der Inaktivität automatisch eine vom Bediener ausgewählte Bewegungsfunktion ausgeführt wird.

1. **Bewegungsart:** Auswahl der aufzurufenden Bewegungsart (None, Home, Autopan, Patrol).
2. **Bewegungsverzug:** Ausfallzeiten Joystick, in Sekunden.

BEWEGUNGSANFORDERUNG	

1>BEWEGUNGSART	: NONE
2 BEWEGUNGSVERZ.	: 60

Abb. 107

10.1.9 Menü Anzeigen

1. **Aktuelle Position:** Wenn nicht auf OFF gestellt, kann die Modalität ausgewählt werden, mit der auf dem Bildschirm die Werte Pan, Tilt, Zoom, Focus und Iris angezeigt werden.
2. **Name Preset:** Wenn nicht auf OFF gestellt, kann die Modalität ausgewählt werden, mit der auf dem Bildschirm der der letzten erreichten Preset- Position zugeordnete Text angezeigt wird. Es kann eine bestimmte Anzeigedauer (1 s, 3 s und 5 s) oder die Daueranzeige (Const) gewählt werden.
3. **ID Schwenk-Neige-Kopf:** Lautet die Einstellung nicht auf OFF, wird die ID des Produktes angezeigt.
4. **Alarme:** Wenn nicht auf OFF gestellt, kann die Modalität ausgewählt werden, mit der die einem Alarm zugeordneten Texte angezeigt werden. Es kann eine bestimmte Anzeigedauer (1 s, 3 s und 5 s) oder die Daueranzeige (Const) gewählt werden.

5. **Empfangene Befehle:** Es wird die Funktion aktiviert, mit der die empfangenen seriellen Befehle angezeigt werden.
6. **Delta Horizontal:** Horizontale Verstellung der Menütexe für eine bessere Zentrierung.
7. **Delta Vertical:** Vertikale Verstellung der Menütexe für eine bessere Zentrierung.
8. **Videosignal:** Format des Videosignals.

ANZEIGEN	

1 AKT. POSITION	: ON
2 NAME PRESET	: 5 S
3 ID	: ON
4 ALARME	: ON
5 RX BEFEHLE	: ON
6 DELTA HORIZONTAL	: 35
7 DELTA VERTIKAL	: 10
8 VIDEOSIGNAL	: PAL

Abb. 108

Das Menü konfiguriert sich je nach Modell des Schwenk-Neige-Kopfes dynamisch selbst.

10.1.10 Menü I/O Digital-Optionen

1. **Alarme:** Zugriff auf das Menü Alarme.
2. **Waschanlage:** Zugriff auf das Menü Waschanlage.
3. **Kommunikation:** Zugriff auf das Menü Kommunikation.

I/O DIGITAL-OPTIONEN	

1>ALARME	>
2 WASCHANLAGE	>
3 KOMMUNIKATION	>

Abb. 109

10.1.10.1 Menü Alarme

- 01-04. **Alarme 1-4:** Zugriff auf die Menüs, in denen die Parameter der Alarme von 1 bis 4 geändert werden können.
05. **Status Alarme:** Zugriff auf das Menü Status Alarme.

```

ALARME
-----
1>ALARME 1      >
2  ALARME 2      >
3  ALARME 3      >
4  ALARME 4      >
5  ALARMSTATUS   >
  
```

Abb. 110

Das Menü konfiguriert sich je nach Modell des Schwenk-Neige-Kopfes dynamisch selbst.

In den Menüs der einzelnen Alarme können die folgenden Werte konfiguriert werden:

- Art:** Wird die Kontaktart, Normalerweise geschlossen (NC) oder normalerweise geöffnet (NO)
- Aktion:** Die Art der Aktion, die der S-N-Kopf ausführt, wenn der Alarm ausgelöst wird (Off, Msg, PTZ Stop, Wiper, Washer, Scan, Patrol, Autopan, Relay, Ir Filt). Der Parameter OFF deaktiviert den Alarm.
- Nummer:** Das anzufahrende Preset, wenn die Art der Aktion für den Alarm Scan lautet.
- Text:** Die Meldung erscheint, wenn der Alarm aktiv ist.

```

ALARME 1
-----
1>ART   :   N.C.
2  AKT. :   SCAN
3  NR.  :    1
4  TEXT :  ALARM 1
  
```

Abb. 111

Das Menü konfiguriert sich dynamisch in Abhängigkeit von der gewählten Einstellung und weist die Parameter aus, die verändert werden können.

Im Menü Status Alarme wird der Status des Eingangs der Alarme angezeigt. (Closed, Open).

```

ALARMSTATUS
-----
ALARM 1      CLOSED
ALARM 2      OPEN
ALLARME 3    CLOSED
ALLARME 4    CLOSED
  
```

Abb. 112

10.1.10.2 Menü Kommunikationen

- ACK Seriell:** Der Schwenk-Neige-Kopf wird so konfiguriert, dass die Übermittlung einer Antwort mit ACK auf die seriellen Steuerbefehle aktiviert oder deaktiviert ist.
- ACK PELCO D Standard:** Konfiguriert wird das Antwort-ACK des Befehls PELCO D. Das Menü ist eingeblendet, wenn über die DIP-Schalter ein anderes Kommunikationsprotokoll als PELCO D eingestellt oder wenn das Antwort-ACK nicht aktiviert ist (SERIELLES ACK = FALSE). Wenn der Menüpunkt aktiviert ist, handelt es sich um ein Standard-Antwort-ACK (die Prüfsumme ist mit der ursprünglichen Nachricht korreliert). Wenn der Menüpunkt deaktiviert ist, wird die Prüfsumme ausschließlich anhand des ACK-Paketes berechnet.

```

KOMMUNIKATION
-----
1  SERIELLES ACK      :  J
2  DEFAULT PELCOD ACK :  N
  
```

Abb. 113

10.1.10.3 Menü Waschanlage

Die Einheit bietet die Möglichkeit, einen Scheibenwischer einzusetzen und eine Pumpe für die Scheibenreinigung zu betätigen.

Zur Einstellung der Waschanlage das Kameraobjektiv vor der Düse der Waschanlage positionieren.

Speichern Sie ein Preset (XY) für diese Position ab, die vom Schwenk-Neige-Kopf bei Aktivierung der Funktion WASHER aufgerufen wird.

Die folgenden Parameter konfigurieren.:

1. **Ein:** Aktivierung der Funktion Waschanlage (Washer).
2. **Preset Düse:** Eingabe der Presetnummer (XY), die der Düse entspricht.
3. **Verzögerung Wischer On:** Auswahl des Zeitintervalls, der zwischen der Aktivierung der Pumpe und der des Scheibenwischers verstreicht.
4. **Dauer Waschvorgang:** Auswahl der Dauer des Bürstvorgangs.
5. **Verzögerung Wischer Off:** Auswahl der Dauer des Bürstvorgangs ohne Wasser.

WASCHANLAGE

```
-----
1>FREIGABE           : N
2 PRESET DUSE       : 1
3 WISCHERVERZOG. ON : 5
4 WASCHVORGANGSDAUER: 10
5 WISCHERVERZOG. OFF: 5
```

Abb. 114

10.1.11 Menü Default

1. **Setup löschen?:** Versetzt alle Parameter außer die Presetparameter in den ursprünglichen Zustand.
2. **Preset löschen?:** Löscht alle gespeicherten Presetpositionen.

DEFAULT

```
-----
1>SETUP LOSCHEN?
2 PRESET LOSCHEN?
```

Abb. 115



Bei den oben beschriebenen Vorgängen gehen alle gespeicherten Daten verloren (z. B. Preset, Patrol, Autopan, Home...).

10.1.12 Menü Info

Das Menü ermöglicht es, die Konfiguration der Einrichtung und die Version der installierten Firmware zu prüfen.

ANMERKUNG

```
-----
Device ID: 00001
Type      : Rs485 only Rx
Baud Rate: 38400-8N1
Protocol  : MACRO
Net Board: Fw6.02 Hw01
Mpp Board: Fw6.02 Hw00
Config.   : 001
P.C.      : UPT1SVSA000E
S.N.      : 000000000000
Upgrade   : NET BOARD
```

Abb. 116

11 Zubehör

i Für weitere Details zur Konfiguration und zum Gebrauch beachten Sie bitte das Handbuch des entsprechenden Geräts.

11.1 Waschanlage

Der Schwenk-Neige-Kopf muss mit einer externen Pumpe ausgestattet sein, die Wasser für die Reinigung des Glases liefert.



Abb. 117

11.1.1 Anschluss der Waschanlage.

! **ACHTUNG!** Die Anlage gehört zum Typ TNV-1. Nicht an Kreisläufe SELV anschließen.

! **ACHTUNG!** Zur Senkung der Brandgefahr dürfen nur UL Listed oder CSA zertifizierte Kabel benutzt werden, die mindestens dem Schnitt 0.14mm² (26AWG) entsprechen.

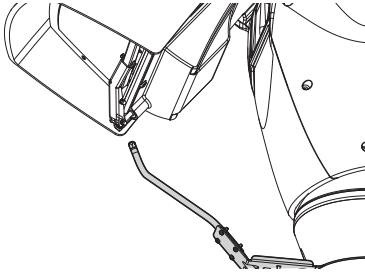
! **Alle Signalkabel mit einem Kabelbinder müssen zusammengefasst werden.**

ANSCHLUSS DER WASCHANLAGE.	
Klemmen	Beschreibung
AL1-COM AL1-AGND	Alarめingang. Die Waschanlagen mit Niveausensor melden den Mangel an Flüssigkeit im Behälter.
O1-C1	Potentialfreier Kontakt für die Aktivierung der Waschanlage.

Tab. 17



Abb. 118 Standardmodell.



Abb. 119 Version mit LED-Scheinwerfern.

i Für weitere Infos bitte entsprechendes Kapitel beachten (10.1.10.3 Menü Waschanlage, Seite 51).

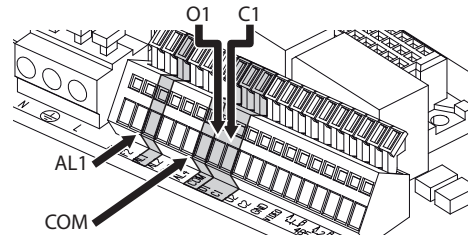
11.2 Wandhalterung

Wandhalterung mit interner Kabelführung.

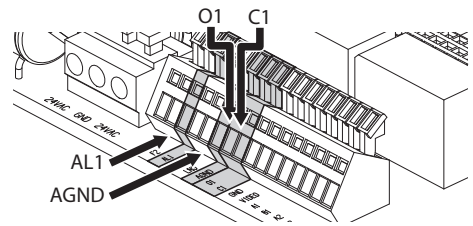

Abb. 120

11.3 Halterung für Brüstungsmontage

Brüstungshalterung mit interner Kabelführung.

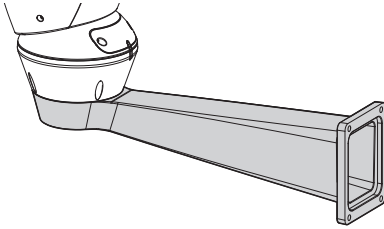

Abb. 121

11.4 Netzteil mit Steuerung der Scheinwerfer

Dichtes Gehäuse mit Netzteil und Kontrolle der Scheinwerfer.

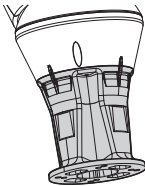

Abb. 122 Standardversion des Gehäuses.



Abb. 123 UL-zertifizierte Version des Gehäuses.

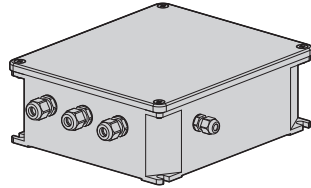

Für weitere Infos bitte entsprechendes Kapitel beachten (8.5.3 Anschluss der Alarmeingänge, der Dämmerungsschalter und der Relais, Seite 26).

12 Anleitung für den normalen Betrieb

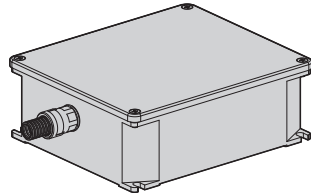
12.1 Statusanzeige Schwenk-Neige-Kopf

Während des normalen Betriebes zeigt der Schwenk-Neige-Kopf nach Wahl des Benutzers auf dem Monitor die wie erläutert organisierten Daten. Die Anzeige kann ein- und ausgeschaltet werden (10.1.9 Menü Anzeigen, Seite 49).

ID 1: Empfängeradresse;

ZONE 1: Name des Bereiches, in dem man sich befindet;

MASK 1: Name der angezeigten Maske.;

ALARM 1: Text des letzten Alarms;

Preset 001 go to: Befehle empfangen über serielle Leitung;

E1: PATROL CONFIGURATION: Anzeige der während des Systembetriebs ermittelten Fehler.;

PAN/TILT/Z/F/I: Aktuelle Position von PAN, TILT, ZOOM, FOCUS und IRIS;

PRESET 001: Name des ausgewählten, aktiven Preset.

```
ID 1
ZONE 1
MASK 1
ALARM1
Preset 001 go to

E1: PATROL CONFIGURATION
PAN : +000.00
TILT: +000.00
Z:000.0 F:000.0 I:000.0
PRESET 001
```

Abb. 124

12.2 Speichern eines Preset.

Mithilfe der verwendeten Steuerungseinrichtung lässt sich die Istposition speichern (weitere Informationen enthält das Handbuch der verwendeten Einrichtung).

12.3 Aufruf einer Position Preset (Scan)

Mithilfe des Kontrollgerätes kann eine zuvor gespeicherte Preset Position aufgerufen werden (weitere Informationen enthält das Handbuch der verwendeten Einrichtung).

12.4 Aufruf der Homeposition

Mithilfe des Kontrollgerätes kann eine zuvor gespeicherte Home (Scan n.1) Position aufgerufen werden (für weitere Informationen siehe das Handbuch des verwendeten Kontrollgerätes).

12.5 Aktivierung Patrol

Bei der Funktion Patrol werden nacheinander die gespeicherten Presets angesteuert.

Für die Aktivierung/Deaktivierung der Funktion siehe Handbuch der verwendeten Steuervorrichtung bzw. entsprechendes Kapitel. (12.11 Spezialbefehle, Seite 56).

Für die Deaktivierung der Funktion den Joystick bewegen oder einen anderen Bewegungstyp abrufen.

Für die Konfiguration dieser Funktion siehe entsprechendes Kapitel. (10.1.8.6 Menü Patrol, Seite 48).

12.6 Aktivierung Autopan

Bei der Funktion Autopan werden die 2 gespeicherten Presets kontinuierlich angesteuert.

Für die Aktivierung/Deaktivierung der Funktion siehe Handbuch der verwendeten Steuervorrichtung bzw. entsprechendes Kapitel. (12.11 Spezialbefehle, Seite 56).

Für die Deaktivierung der Funktion den Joystick bewegen oder einen anderen Bewegungstyp abrufen.

Für die Konfiguration dieser Funktion siehe entsprechendes Kapitel. (10.1.8.7 Menü Autopan, Seite 48).

12.7 Aktivierung der Scheibenwischer (Wiper)



Der Scheibenwischer ist bei Aussentemperaturen unter 0°C oder bei Glas nicht zu betätigen.

Für die Aktivierung/Deaktivierung der Funktion siehe Handbuch der verwendeten Steuervorrichtung bzw. entsprechendes Kapitel. (12.11 Spezialbefehle, Seite 56).



Der Scheibenwischer schaltet sich automatisch aus, wenn er laufen gelassen wird.

12.8 Aktivierung der Waschanlage (Washer)

Wird der Befehl abgesendet, positioniert sich der Schwenk-Neige-Kopf mit dem Fenster vor der Düse.. Es werden nun für eine bestimmte Zeit die Pumpe und der Scheibenwischer aktiviert. Am Ende des Vorgangs kehrt der S-N-Kopf in die Ausgangsposition zurück.

Für die Aktivierung/Deaktivierung der Funktion siehe Handbuch der verwendeten Steuervorrichtung bzw. entsprechendes Kapitel. (12.11 Spezialbefehle, Seite 56).

Für die Aktivierung der speziellen Konfigurationen siehe entsprechendes Kapitel. (12.12 Sonderkonfigurationen, Seite 57).

Bei den Modellen mit Waschanlagen mit Standsensor kann außerdem eine Bildschirnmachricht anzeigen, wenn der Flüssigkeitsstand im Behälter zu gering ist (nur bei Verwendung einer Pumpe mit hoher Druckhöhe).

12.9 Aktivierung des LED-Scheinwerfer

Wenn die Anlage über keinen Dämmerungsschalter verfügt, kann der LED- Scheinwerfer mit der entsprechenden Steuerung aktiviert/deaktiviert werden. (12.11 Spezialbefehle, Seite 56).

12.10 Reboot der Einheit

Mithilfe des Kontrollgerätes lässt sich der Befehl für den Reboot der Einrichtung absenden (für weitere Informationen siehe das Handbuch des verwendeten Kontrollgerätes).

Für weitere Infos bitte entsprechendes Kapitel beachten (12.11 Spezialbefehle, Seite 56).

12.11 Spezialbefehle

SPEZIALBEFEHLE						
Aktion	Befehl					
	Protokoll					
	AMERICAN DYNAMICS	ERNITEC	PANASONIC	PELCO D	VIDEOTEC MACRO	VISTA
Wiper Start	Preset Speichern 85	Preset Speichern 85	Preset Speichern 85	Preset Speichern 85	Preset Speichern 85	Preset Speichern 85
	Aux 3 ON	Aux 3 ON	Preset Speichern 54	Aux 3 ON	Aux 3 ON	Aux 3 ON
					Wip+	
Wiper Stop	Preset Speichern 86	Preset Speichern 86	Preset Speichern 86	Preset Speichern 86	Preset Speichern 86	Preset Speichern 86
	Aux 3 OFF	Aux 3 OFF	Preset Speichern 55	Aux 3 OFF	Aux 3 OFF	Aux 3 OFF
					Wip-	
Washer Start	Preset Speichern 87	Preset Speichern 87	Preset Speichern 87	Preset Speichern 87	Preset Speichern 87	Preset Speichern 87
	Aux 4 ON	Aux 4 ON	Preset Speichern 56	Aux 4 ON	Aux 4 ON	Aux 4 ON
					Was+	
Nachtmodus On	Preset Speichern 88	Preset Speichern 88	Preset Speichern 88	Preset Speichern 88	Preset Speichern 88	Preset Speichern 88
			Preset Speichern 57			
Nachtmodus Off	Preset Speichern 89	Preset Speichern 89	Preset Speichern 89	Preset Speichern 89	Preset Speichern 89	Preset Speichern 89
			Preset Speichern 58			
Patrol Stop	Preset Speichern 92	Preset Speichern 92	Preset Speichern 92	Preset Speichern 92	Preset Speichern 92	Preset Speichern 92
	Joystick	Joystick	Joystick	Joystick	Joystick	Joystick
			Preset Speichern 59		Pat-	
Patrol Start	Preset Speichern 93	Preset Speichern 93	Preset Speichern 93	Preset Speichern 93	Preset Speichern 93	Preset Speichern 93
	Einschalten pattern 1	Einschalten patrol	Preset Speichern 60	Pattern	Pat+	Einschalten Patrol
Reboot der Einrichtung	Preset Speichern 94	Preset Speichern 94	Preset Speichern 94	Preset Speichern 94	Preset Speichern 94	Preset Speichern 94
	Faster+ Zoom out+ Focus far+ Iris open		Preset Speichern 61		Ini+	
Aktivierung OSM	Preset Speichern 95	Preset Speichern 95	Preset Speichern 95	Preset Speichern 95	Preset Speichern 95	Preset Speichern 95
	Iris open+ Focus+ Zoom out		Preset Speichern 46		Men+	
Autopan Stop	Preset Speichern 96	Preset Speichern 96	Preset Speichern 96	Preset Speichern 96	Preset Speichern 96	Preset Speichern 96
	Joystick	Joystick	Joystick	Joystick	Joystick	Joystick
			Preset Speichern 62		Apa-	
Autopan Start	Preset Speichern 99	Preset Speichern 99	Preset Speichern 99	Preset Speichern 99	Preset Speichern 99	Preset Speichern 99
	Einschalten Pattern 2	Einschalten Autopan	Preset Speichern 63	Pattern 1	Apa+	Einschalten Autopan

Tab. 18

12.12 Sonderkonfigurationen

SONDERKONFIGURATIONEN					
Konfiguration	Protokoll				
	AMERICAN DYNAMICS	PANASONIC	PELCO D	VIDEOTEC MACRO	VISTA
Washer - Konfiguration 1 (Kurzwäsche)	Preset Speichern 72	Preset Speichern 72	Preset Speichern 72	Preset Speichern 72	Preset Speichern 72
Washer - Konfiguration 2 (Langwäsche)	Preset Speichern 73	Preset Speichern 73	Preset Speichern 73	Preset Speichern 73	Preset Speichern 73

Tab. 19

13 Wartung



Die Wartung darf nur von Fachleuten vorgenommen werden, die befähigt sind, an elektrischen Schaltkreisen tätig zu werden.

13.1 Wechsel der Sicherungen



Wartung nur durchführen, wenn die Stromversorgung abgetrennt und die Trennvorrichtung offen ist.

Falls notwendig die abgebildeten Sicherungen austauschen (8.3 Beschreibung der Karte Anschlüsse, Seite 21).

WECHSEL DER SICHERUNGEN		
Spannung	Schmelz- siche- rung F1	Schmelz- siche- rung F2
24Vac, 50/60Hz	T 4A L 250V 5x20	T 6.3A H 250V 5x20 (Standard-Ausführung.)
		T 8A H 250V 5x20 (Version mit LED-Scheinwerfern)
120Vac, 50/60Hz	T 4A L 250V 5x20	T 4A H 250V 5x20
230Vac, 50/60Hz	T 4A L 250V 5x20	T 2A H 250V 5x20

Tab. 20

14 Reinigung

14.1 Reinigung des Glases und der Kunststoffteile



Zu vermeiden sind Äthylalkohol, Lösungsmittel, hydrierte Kohlenwasserstoffe, starke Säuren und Alkali. Diese Produkte können die behandelte Oberfläche beschädigen.

Es wird empfohlen, ein weiches Tuch und neutrale mit Wasser verdünnte Seife oder ein spezifisches Reinigungsmittel für Brillengläser zu verwenden.

14.2 Putzen des Germaniumfensters



Bei der Reinigung des Fensters ist darauf zu achten, dass die mit Carbon Coating behandelte Oberfläche nicht verkratzt oder gerillt wird. Wenn diese Beschichtung Schaden nimmt, besteht die Gefahr, dass die Durchlässigkeit der Oberfläche für Infrarotstrahlen beeinträchtigt wird.

Die Reinigung sollte mit einer milden Seife mit Wasser verdünnt erfolgen.

15 Müllentsorgungsstellen



Dieses Symbol und das entsprechende Recycling-System gelten nur für EULänder und finden in den anderen Ländern der Welt keine Anwendung.

Ihr Produkt wurde entworfen und hergestellt aus qualitativ hochwertigen Materialien und Komponenten, die recycelt und wiederverwendet werden können.

Dieses Symbol bedeutet, daß elektrische und elektronische Geräte am Ende ihrer Nutzungsdauer von Hausmüll getrennt entsorgt werden sollen.

Bitte entsorgen Sie dieses Gerät bei Ihrer örtlichen Sammelstelle oder im Recycling Centre.

In der Europäischen Union gibt es unterschiedliche Sammelsysteme für Elektrik- und Elektronikgeräte.

16 Problemlösung

Fordern Sie Fachleute für die Arbeiten an, wenn:

- Die Einheit nach einem Sturz beschädigt ist;
- Die Leistungen der Einheit merklich abgefallen sind.
- Die Einheit trotz der Befolgung sämtlicher Ausführungen in diesem Handbuch nicht korrekt funktioniert.

PROBLEM Das Produkt lässt sich nicht einschalten.

URSACHE Falsche Verkabelung, Schmelzsicherungen durchgebrannt.

LÖSUNG Anschlüsse prüfen. Die Kontinuität der Sicherungen überprüfen und im Falle eines Defektes müssen sie durch die aufgeführten Modelle ersetzt werden.

PROBLEM Unter bestimmten Zoom-Bedingungen kommt es zur Interferenz des Gehäuses oder des Sonnenschutzdaches im aufgenommenen Bild (nur für Versionen mit motorisierter Optik).

URSACHE Position der Videokamera oder Optik im Verhältnis zum Fenster zu sehr zurückgesetzt.

LÖSUNG Die Position der Videokamera und der Optik einstellen.

PROBLEM Das Bild der Aufnahme erscheint nicht, aber eine blaue Bildschirmseite mit der Meldung: **No Video Signal!!!**.

URSACHE Fehlerhafte Verkabelung der Kamera oder Kamera defekt.

LÖSUNG Anschlüsse prüfen.

PROBLEM Während der Einschaltung bleibt der Schwenk-Neige-Kopf blockiert. Es erscheint eine Bildschirmseite folgender Art:

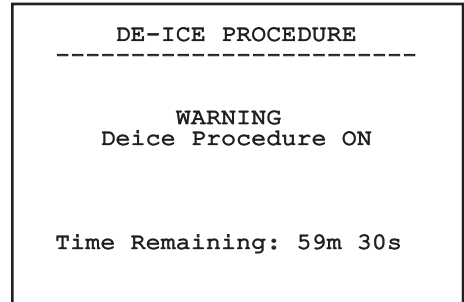

URSACHE Die Umgebungstemperatur ist sehr niedrig.

LÖSUNG Ende des Vorheizvorgangs abwarten. Wenn die Umgebungstemperatur zu niedrig ist, bleibt der Schwenk-Neige-Kopf blockiert und es wird folgende Bildschirmseite angezeigt.

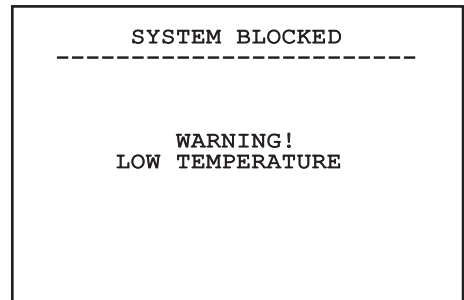

PROBLEM Das Bild der Aufnahme erscheint nicht, aber eine Bildschirmseite der Art:

ANMERKUNG

```

Device ID: 00001
Type      : Rs485 only Rx
Baud Rate: 19200-8N1
Protocol  : PELCO-D
Net Board: Fw05.01 Hw00
Mpp Board: Fw05.01 Hw00
Config.   : 001
P.C.      : UPT1SMSA005C
S.N.      : 0000000000000
Upgrade   : NET BOARD
  
```

URSACHE Programmier-Dipschalter aktiv.

LÖSUNG Den Schwenk-Neige-Kopf ausschalten. Den Hebel des Dipschalters für Firmware-Update senken. (8.14.2 Konfiguration der DIP1, Seite 34). Die Einheit erneut einschalten.

PROBLEM Fehler E1: PATROL CONFIGURATION.

URSACHE Die Preset wurden nicht gespeichert.
Die Preset wurden nicht aktiviert.

LÖSUNG Speichern von zwei oder mehreren Preset. (12.2 Speichern eines Preset., Seite 54). Das Konfigurationsmenü Patrol aktualisieren. (10.1.8.6 Menü Patrol, Seite 48).

Die Preset aktivieren. (10.1.8.4 Menü Preset (Preset Ändern), Seite 47).

PROBLEM Fehler E2:AUTOPAN CONFIGURATION.

URSACHE Die beiden als Schwellen verwendeten Preset wurden nicht gespeichert.

Die beiden als Schwellen verwendeten Preset wurden nicht aktiviert.

LÖSUNG Speichern der beiden Preset. (12.2 Speichern eines Preset., Seite 54). Das Konfigurationsmenü Autopan aktualisieren. (10.1.8.7 Menü Autopan, Seite 48).

Die Preset aktivieren. (10.1.8.4 Menü Preset (Preset Ändern), Seite 47).

PROBLEM Fehler E3:WASHER DISABLED oder Fehler E4:WASHER PRST DISABLED.

URSACHE Waschanlage nicht aktiviert.

LÖSUNG Waschanlage einschalten (10.1.10.3 Menü Waschanlage, Seite 51).

PROBLEM Fehler PRESET XXX NOT ENABLED.

URSACHE Aufruf eines nicht gespeicherten Preset.

Aufruf eines nicht aktivierten Preset.

LÖSUNG Das Preset mit dem zugehörigen Befehl speichern (12.2 Speichern eines Preset., Seite 54).

Den Preset aktivieren. (10.1.8.4 Menü Preset (Preset Ändern), Seite 47).

17 Technische Daten

17.1 Allgemeines

Konstruktion aus Aluminiumdruckguss und Technopolymer

Pulverlackierung mit Epoxydpolyester, Farbe RAL9002

Top mount (OTT)

Elektronische Endschalter

Kein mechanisches Spiel

Höchstes Gewicht für Kameras und Optik: 7.6kg

Optische Sensoren für Feedback bei absoluter Positionierung

Maximale Anzahl der Presets: 250 (VIDEOTEC MACRO)

Kette aus 15 Zeichen für die Betitelung des Bereiches oder der Presets

Durch OSM konfigurierbar

Bis zu 255 Einheiten mit DIP-schalter adressierbar

17.2 Mechanik

Kabelverschraubungen: 3xM16

Horizontale Drehung: kontinuierlich

Neigung: von +45° bis zu -20°

Schwenkgeschwindigkeit rechts - links (einstellbar): von 0.02°/s bis zu 20°/s

Neigegeschwindigkeit Auf-Ab einstellbar (einstellbar): von 0.02°/s bis zu 20°/s

Innere Nutzabmessungen: Siehe Zeichnungen

Zahnriemenantrieb

Genauigkeit beim Aufruf der Preset- Positionen: 0.02°

Einheitsgewicht: 30kg

17.3 Fenster für Gehäuse

Glasfenster

- Abmessungen: 112mmx95mm

Fensterscheibe aus Germanium

- Durchmesser: 85mm (Außen), 70mm (Nutzdurchmesser)
- Stärke: 2mm
- Externes kratzfestes Finish: Hard Carbon Coating (DLC)
- Entspiegelte Innenbehandlung

Spektralbereich: von 7.5µm bis zu 14µm

Mittel Transmittanz (von 7.5µm bis zu 11.5µm): 94%

Mittel Transmittanz (von 11.5µm bis zu 14µm): 90%

Durchlässigkeit des Fensters aus Germanium



Abb. 125

17.4 Elektrik

Versorgungsspannung/Stromaufnahme:

- 230Vac, 0.4A, 50/60Hz
- 24Vac, 4A (8A mit LED Scheinwerfern), 50/60Hz
- 120Vac, 0.8A, 50/60Hz

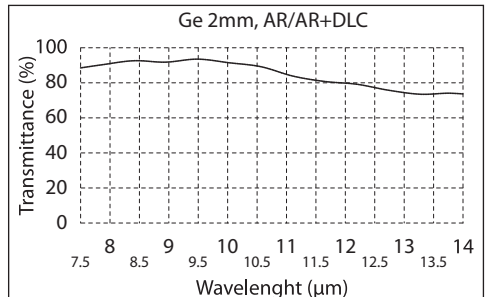
Leistungsaufnahme:

- 100W
- 150-190W max mit LED Scheinwerfern in 24Vac
- 24W, S-N-Kopf unbewegt, ohne Heizung

Kamerversorgung: 12Vdc, 800mA

Querschnitt der Eingangskabel:

- 0.75mm² (18AWG), 120Vac oder 230Vac
- 1.5mm² (16AWG), 24Vac

Querschnitt der Signalkabel: von 0.14mm² (26AWG) bis zu 0.5mm² (20AWG)

17.5 Video

Videoleitung: Koaxialkabel (1Vpp, 75Ohm)

17.6 Kommunikation

RS-232-Schnittstelle für Firmware-Update

2 RS-485- Anschlüsse für Daisy-Chain-Konfiguration

17.7 Protokolle

Konfiguration mit DIP-schaltern der Parameter der Telemetrie-Protokolle.

Unterstützte Protokolle:

- AMERICAN DYNAMICS
- PANASONIC
- PELCO D
- VIDEOTEC MACRO
- VISTA

17.8 I/O-Schnittstelle

Alarめingänge:

- 4 (Standard-Ausführung.)
- 2 (Version mit LED- Scheinwerfern)
- Steuerspannung: Von 10Vdc bis zu 35Vdc

Potentialfreie Kontakte:

- 2 (Standard-Ausführung.)
- 1 (Version mit LED- Scheinwerfern)
- Anwendbare Spannung: 50Vdc max oder 30Vac @1A

17.9 Optiken

Netzteil: Von 6Vdc a 15Vdc, 200mA max

Steuerung: Mit Polaritätsumkehr und mit gemeinsamem Draht

17.10 Umgebung

Innen/Außen

Betriebstemperatur (mit Heizung): Von -10° bis zu +60°C

17.11 Zertifizierungen

Elektrische Sicherheit (CE): EN60950-1

Elektromagnetische Verträglichkeit (CE): EN50130-4, EN55022 (Klasse B), FCC Part 15 (Klasse B)

Außeninstallation (CE): EN60950-22

Schutzart IP: EN60529 (IP66)

Salznebelbeständig: EN50130-5, EN60068-2-52

EAC-Zertifizierung

18 Technische Zeichnungen



Die Abmessungen der Zeichnungen sind in Millimeter angegeben.



Abb. 126 ULISSE MAXI, Standard-Ausführung..



Abb. 127 ULISSE MAXI, Version mit Vorrüstung für zwei LED-Scheinwerfer.

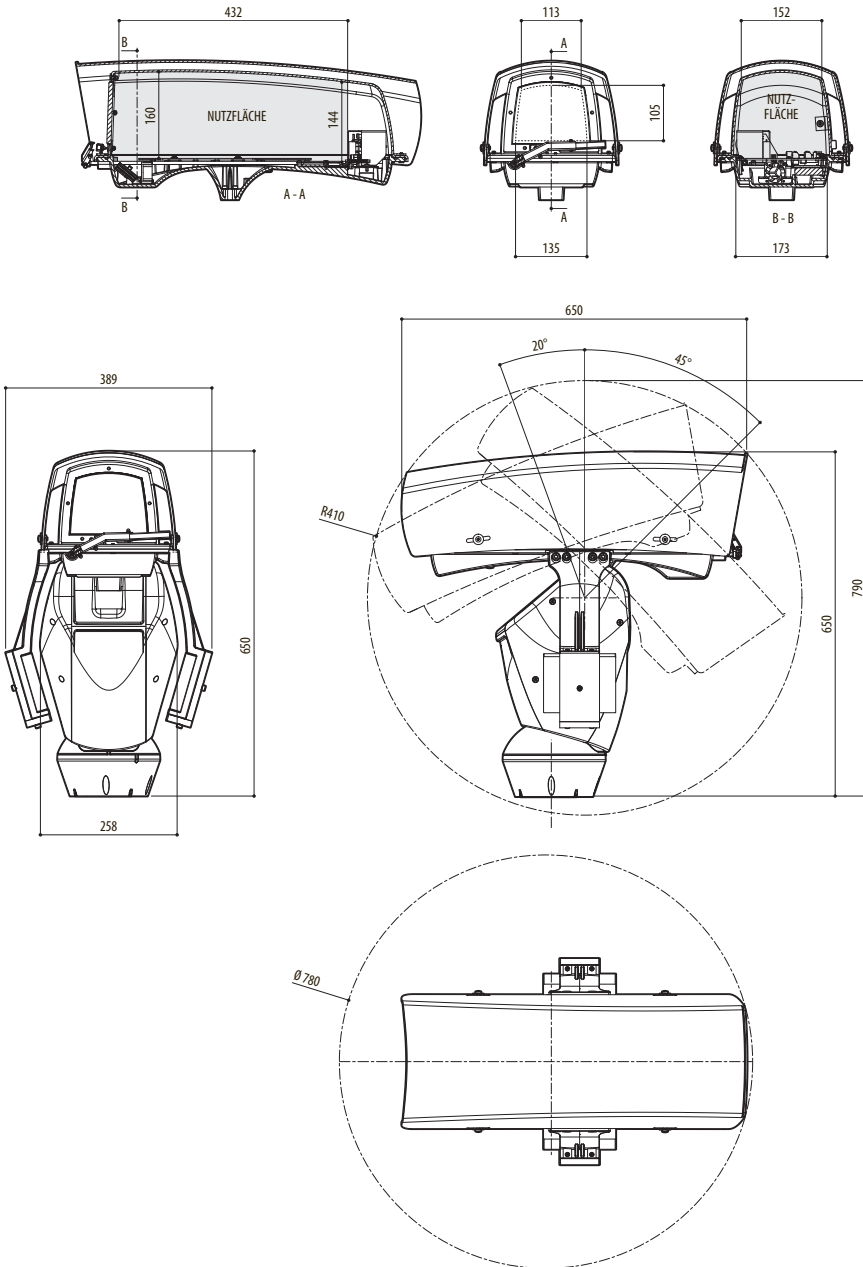

Abb. 128 ULISSE MAXI, Version für Wärmebildkameras.

A Anhang - Adressentabelle

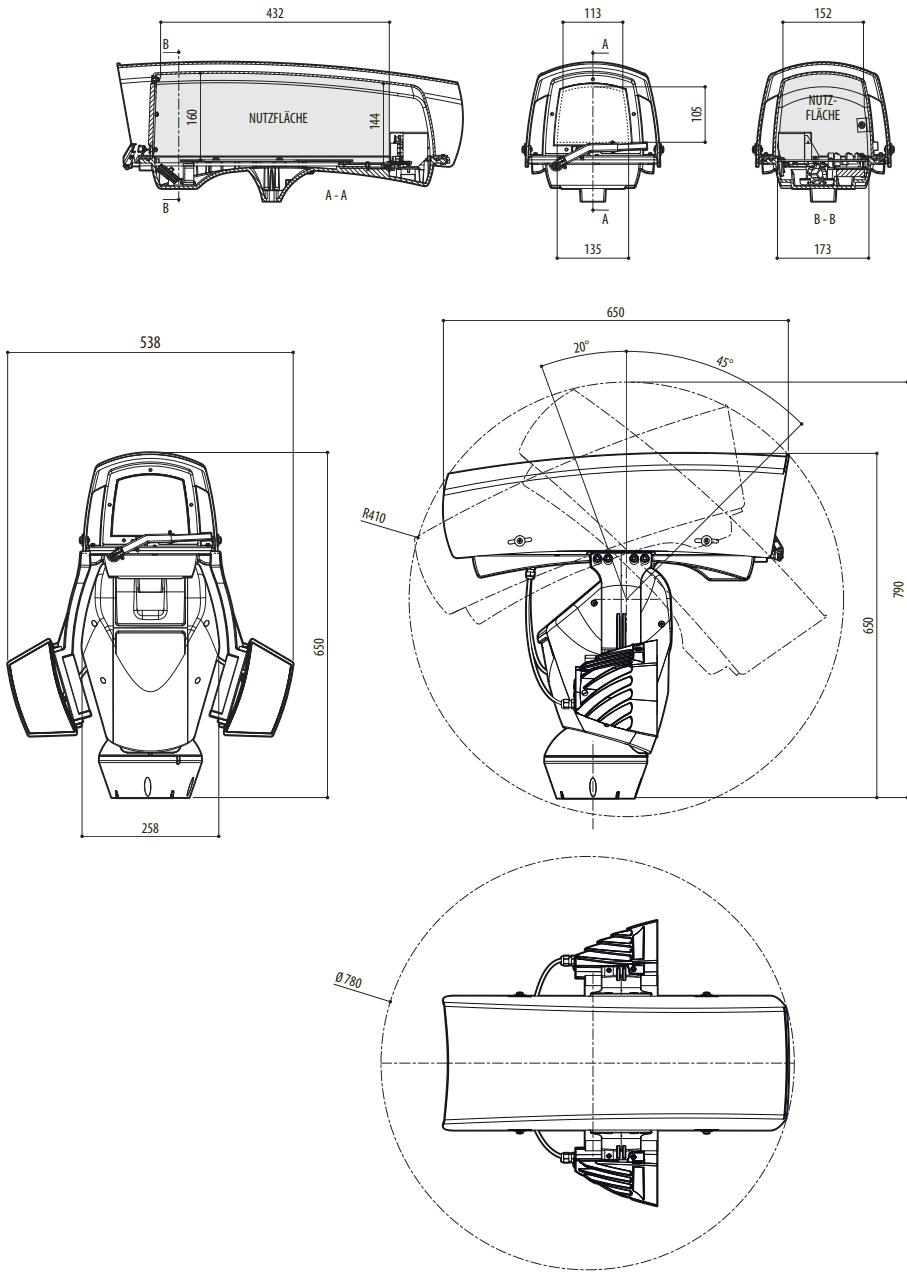

Der nach oben zeigende Kipphebel des Schalters steht für den Wert 1 (ON). Der nach unten zeigende Kipphebel des Dipschalters steht für den Wert 0 (OFF).

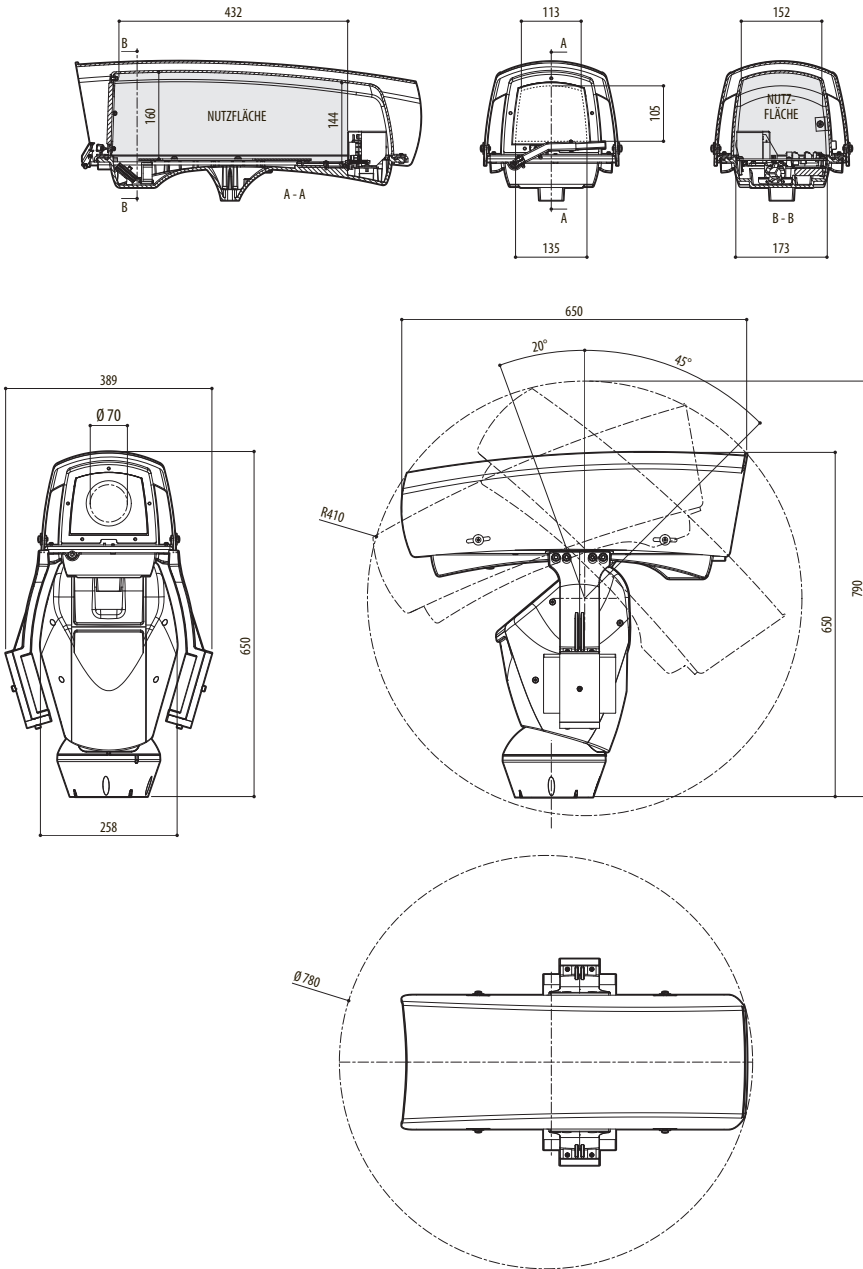
Nachstehend sind alle Kombinationsmöglichkeiten aufgelistet.

ADRESSEKONFIGURATION (DIP 3)								
SW 8	SW 7	SW 6	SW 5	SW 4	SW 3	SW 2	SW 1	Adresse
OFF	OFF	OFF	OFF	OFF	OFF	OFF	OFF	Adresse unfähige
OFF	OFF	OFF	OFF	OFF	OFF	OFF	ON	Adresse 1
OFF	OFF	OFF	OFF	OFF	OFF	ON	OFF	Adresse 2
OFF	OFF	OFF	OFF	OFF	OFF	ON	ON	Adresse 3
OFF	OFF	OFF	OFF	OFF	ON	OFF	OFF	Adresse 4
OFF	OFF	OFF	OFF	OFF	ON	OFF	ON	Adresse 5
OFF	OFF	OFF	OFF	OFF	ON	ON	OFF	Adresse 6
OFF	OFF	OFF	OFF	OFF	ON	ON	ON	Adresse 7
OFF	OFF	OFF	OFF	ON	OFF	OFF	OFF	Adresse 8
OFF	OFF	OFF	OFF	ON	OFF	OFF	ON	Adresse 9
OFF	OFF	OFF	OFF	ON	OFF	ON	OFF	Adresse 10
OFF	OFF	OFF	OFF	ON	OFF	ON	ON	Adresse 11
OFF	OFF	OFF	OFF	ON	ON	OFF	OFF	Adresse 12
OFF	OFF	OFF	OFF	ON	ON	OFF	ON	Adresse 13
OFF	OFF	OFF	OFF	ON	ON	ON	OFF	Adresse 14
OFF	OFF	OFF	OFF	ON	ON	ON	ON	Adresse 15
OFF	OFF	OFF	ON	OFF	OFF	OFF	OFF	Adresse 16
OFF	OFF	OFF	ON	OFF	OFF	OFF	ON	Adresse 17
OFF	OFF	OFF	ON	OFF	OFF	ON	OFF	Adresse 18
OFF	OFF	OFF	ON	OFF	OFF	ON	ON	Adresse 19
OFF	OFF	OFF	ON	OFF	ON	OFF	OFF	Adresse 20
OFF	OFF	OFF	ON	OFF	ON	OFF	ON	Adresse 21
OFF	OFF	OFF	ON	OFF	ON	ON	OFF	Adresse 22
OFF	OFF	OFF	ON	OFF	ON	ON	ON	Adresse 23
OFF	OFF	OFF	ON	ON	OFF	OFF	OFF	Adresse 24
OFF	OFF	OFF	ON	ON	OFF	OFF	ON	Adresse 25
OFF	OFF	OFF	ON	ON	OFF	ON	OFF	Adresse 26
OFF	OFF	OFF	ON	ON	OFF	ON	ON	Adresse 27
OFF	OFF	OFF	ON	ON	ON	OFF	OFF	Adresse 28
OFF	OFF	OFF	ON	ON	ON	OFF	ON	Adresse 29
OFF	OFF	OFF	ON	ON	ON	ON	OFF	Adresse 30
OFF	OFF	OFF	ON	ON	ON	ON	ON	Adresse 31
OFF	OFF	ON	OFF	OFF	OFF	OFF	OFF	Adresse 32
OFF	OFF	ON	OFF	OFF	OFF	OFF	ON	Adresse 33
OFF	OFF	ON	OFF	OFF	OFF	ON	OFF	Adresse 34
OFF	OFF	ON	OFF	OFF	OFF	ON	ON	Adresse 35
OFF	OFF	ON	OFF	OFF	ON	OFF	OFF	Adresse 36
OFF	OFF	ON	OFF	OFF	ON	OFF	ON	Adresse 37
OFF	OFF	ON	OFF	OFF	ON	ON	OFF	Adresse 38

ADRESSEKONFIGURATION (DIP 3)

SW 8	SW 7	SW 6	SW 5	SW 4	SW 3	SW 2	SW 1	Adresse
OFF	OFF	ON	OFF	OFF	ON	ON	ON	Adresse 39
OFF	OFF	ON	OFF	ON	OFF	OFF	OFF	Adresse 40
OFF	OFF	ON	OFF	ON	OFF	OFF	ON	Adresse 41
OFF	OFF	ON	OFF	ON	OFF	ON	OFF	Adresse 42
OFF	OFF	ON	OFF	ON	OFF	ON	ON	Adresse 43
OFF	OFF	ON	OFF	ON	ON	OFF	OFF	Adresse 44
OFF	OFF	ON	OFF	ON	ON	OFF	ON	Adresse 45
OFF	OFF	ON	OFF	ON	ON	ON	OFF	Adresse 46
OFF	OFF	ON	OFF	ON	ON	ON	ON	Adresse 47
OFF	OFF	ON	ON	OFF	OFF	OFF	OFF	Adresse 48
OFF	OFF	ON	ON	OFF	OFF	OFF	ON	Adresse 49
OFF	OFF	ON	ON	OFF	OFF	ON	OFF	Adresse 50
OFF	OFF	ON	ON	OFF	OFF	ON	ON	Adresse 51
OFF	OFF	ON	ON	OFF	ON	OFF	OFF	Adresse 52
OFF	OFF	ON	ON	OFF	ON	OFF	ON	Adresse 53
OFF	OFF	ON	ON	OFF	ON	ON	OFF	Adresse 54
OFF	OFF	ON	ON	OFF	ON	ON	ON	Adresse 55
OFF	OFF	ON	ON	ON	OFF	OFF	OFF	Adresse 56
OFF	OFF	ON	ON	ON	OFF	OFF	ON	Adresse 57
OFF	OFF	ON	ON	ON	OFF	ON	OFF	Adresse 58
OFF	OFF	ON	ON	ON	OFF	ON	ON	Adresse 59
OFF	OFF	ON	ON	ON	ON	OFF	OFF	Adresse 60
OFF	OFF	ON	ON	ON	ON	OFF	ON	Adresse 61
OFF	OFF	ON	ON	ON	ON	ON	OFF	Adresse 62
OFF	OFF	ON	ON	ON	ON	ON	ON	Adresse 63
OFF	ON	OFF	OFF	OFF	OFF	OFF	OFF	Adresse 64
OFF	ON	OFF	OFF	OFF	OFF	OFF	ON	Adresse 65
OFF	ON	OFF	OFF	OFF	OFF	ON	OFF	Adresse 66
OFF	ON	OFF	OFF	OFF	OFF	ON	ON	Adresse 67
OFF	ON	OFF	OFF	OFF	ON	OFF	OFF	Adresse 68
OFF	ON	OFF	OFF	OFF	ON	OFF	ON	Adresse 69
OFF	ON	OFF	OFF	OFF	ON	ON	OFF	Adresse 70
OFF	ON	OFF	OFF	OFF	ON	ON	ON	Adresse 71
OFF	ON	OFF	OFF	ON	OFF	OFF	OFF	Adresse 72
OFF	ON	OFF	OFF	ON	OFF	OFF	ON	Adresse 73
OFF	ON	OFF	OFF	ON	OFF	ON	OFF	Adresse 74
OFF	ON	OFF	OFF	ON	OFF	ON	ON	Adresse 75
OFF	ON	OFF	OFF	ON	ON	OFF	OFF	Adresse 76
OFF	ON	OFF	OFF	ON	ON	OFF	ON	Adresse 77
OFF	ON	OFF	OFF	ON	ON	ON	OFF	Adresse 78
OFF	ON	OFF	OFF	ON	ON	ON	ON	Adresse 79
OFF	ON	OFF	ON	OFF	OFF	OFF	OFF	Adresse 80
OFF	ON	OFF	ON	OFF	OFF	OFF	ON	Adresse 81
OFF	ON	OFF	ON	OFF	OFF	ON	OFF	Adresse 82

ADRESSEKONFIGURATION (DIP 3)

SW 8	SW 7	SW 6	SW 5	SW 4	SW 3	SW 2	SW 1	Adresse
OFF	ON	OFF	ON	OFF	OFF	ON	ON	Adresse 83
OFF	ON	OFF	ON	OFF	ON	OFF	OFF	Adresse 84
OFF	ON	OFF	ON	OFF	ON	OFF	ON	Adresse 85
OFF	ON	OFF	ON	OFF	ON	ON	OFF	Adresse 86
OFF	ON	OFF	ON	OFF	ON	ON	ON	Adresse 87
OFF	ON	OFF	ON	ON	OFF	OFF	OFF	Adresse 88
OFF	ON	OFF	ON	ON	OFF	OFF	ON	Adresse 89
OFF	ON	OFF	ON	ON	OFF	ON	OFF	Adresse 90
OFF	ON	OFF	ON	ON	OFF	ON	ON	Adresse 91
OFF	ON	OFF	ON	ON	ON	OFF	OFF	Adresse 92
OFF	ON	OFF	ON	ON	ON	OFF	ON	Adresse 93
OFF	ON	OFF	ON	ON	ON	ON	OFF	Adresse 94
OFF	ON	OFF	ON	ON	ON	ON	ON	Adresse 95
OFF	ON	ON	OFF	OFF	OFF	OFF	OFF	Adresse 96
OFF	ON	ON	OFF	OFF	OFF	OFF	ON	Adresse 97
OFF	ON	ON	OFF	OFF	OFF	ON	OFF	Adresse 98
OFF	ON	ON	OFF	OFF	OFF	ON	ON	Adresse 99
OFF	ON	ON	OFF	OFF	ON	OFF	OFF	Adresse 100
OFF	ON	ON	OFF	OFF	ON	OFF	ON	Adresse 101
OFF	ON	ON	OFF	OFF	ON	ON	OFF	Adresse 102
OFF	ON	ON	OFF	OFF	ON	ON	ON	Adresse 103
OFF	ON	ON	OFF	ON	OFF	OFF	OFF	Adresse 104
OFF	ON	ON	OFF	ON	OFF	OFF	ON	Adresse 105
OFF	ON	ON	OFF	ON	OFF	ON	OFF	Adresse 106
OFF	ON	ON	OFF	ON	OFF	ON	ON	Adresse 107
OFF	ON	ON	OFF	ON	ON	OFF	OFF	Adresse 108
OFF	ON	ON	OFF	ON	ON	OFF	ON	Adresse 109
OFF	ON	ON	OFF	ON	ON	ON	OFF	Adresse 110
OFF	ON	ON	OFF	ON	ON	ON	ON	Adresse 111
OFF	ON	ON	ON	OFF	OFF	OFF	OFF	Adresse 112
OFF	ON	ON	ON	OFF	OFF	OFF	ON	Adresse 113
OFF	ON	ON	ON	OFF	OFF	ON	OFF	Adresse 114
OFF	ON	ON	ON	OFF	OFF	ON	ON	Adresse 115
OFF	ON	ON	ON	OFF	ON	OFF	OFF	Adresse 116
OFF	ON	ON	ON	OFF	ON	OFF	ON	Adresse 117
OFF	ON	ON	ON	OFF	ON	ON	OFF	Adresse 118
OFF	ON	ON	ON	OFF	ON	ON	ON	Adresse 119
OFF	ON	ON	ON	ON	OFF	OFF	OFF	Adresse 120
OFF	ON	ON	ON	ON	OFF	OFF	ON	Adresse 121
OFF	ON	ON	ON	ON	OFF	ON	OFF	Adresse 122
OFF	ON	ON	ON	ON	OFF	ON	ON	Adresse 123
OFF	ON	ON	ON	ON	ON	OFF	OFF	Adresse 124
OFF	ON	ON	ON	ON	ON	OFF	ON	Adresse 125
OFF	ON	ON	ON	ON	ON	ON	OFF	Adresse 126

ADRESSEKONFIGURATION (DIP 3)

SW 8	SW 7	SW 6	SW 5	SW 4	SW 3	SW 2	SW 1	Adresse
OFF	ON	ON	ON	ON	ON	ON	ON	Adresse 127
ON	OFF	OFF	OFF	OFF	OFF	OFF	OFF	Adresse 128
ON	OFF	OFF	OFF	OFF	OFF	OFF	ON	Adresse 129
ON	OFF	OFF	OFF	OFF	OFF	ON	OFF	Adresse 130
ON	OFF	OFF	OFF	OFF	OFF	ON	ON	Adresse 131
ON	OFF	OFF	OFF	OFF	ON	OFF	OFF	Adresse 132
ON	OFF	OFF	OFF	OFF	ON	OFF	ON	Adresse 133
ON	OFF	OFF	OFF	OFF	ON	ON	OFF	Adresse 134
ON	OFF	OFF	OFF	OFF	ON	ON	ON	Adresse 135
ON	OFF	OFF	OFF	ON	OFF	OFF	OFF	Adresse 136
ON	OFF	OFF	OFF	ON	OFF	OFF	ON	Adresse 137
ON	OFF	OFF	OFF	ON	OFF	ON	OFF	Adresse 138
ON	OFF	OFF	OFF	ON	OFF	ON	ON	Adresse 139
ON	OFF	OFF	OFF	ON	ON	OFF	OFF	Adresse 140
ON	OFF	OFF	OFF	ON	ON	OFF	ON	Adresse 141
ON	OFF	OFF	OFF	ON	ON	ON	OFF	Adresse 142
ON	OFF	OFF	OFF	ON	ON	ON	ON	Adresse 143
ON	OFF	OFF	ON	OFF	OFF	OFF	OFF	Adresse 144
ON	OFF	OFF	ON	OFF	OFF	OFF	ON	Adresse 145
ON	OFF	OFF	ON	OFF	OFF	ON	OFF	Adresse 146
ON	OFF	OFF	ON	OFF	OFF	ON	ON	Adresse 147
ON	OFF	OFF	ON	OFF	ON	OFF	OFF	Adresse 148
ON	OFF	OFF	ON	OFF	ON	OFF	ON	Adresse 149
ON	OFF	OFF	ON	OFF	ON	ON	OFF	Adresse 150
ON	OFF	OFF	ON	OFF	ON	ON	ON	Adresse 151
ON	OFF	OFF	ON	ON	OFF	OFF	OFF	Adresse 152
ON	OFF	OFF	ON	ON	OFF	OFF	ON	Adresse 153
ON	OFF	OFF	ON	ON	OFF	ON	OFF	Adresse 154
ON	OFF	OFF	ON	ON	OFF	ON	ON	Adresse 155
ON	OFF	OFF	ON	ON	ON	OFF	OFF	Adresse 156
ON	OFF	OFF	ON	ON	ON	OFF	ON	Adresse 157
ON	OFF	OFF	ON	ON	ON	ON	OFF	Adresse 158
ON	OFF	OFF	ON	ON	ON	ON	ON	Adresse 159
ON	OFF	ON	OFF	OFF	OFF	OFF	OFF	Adresse 160
ON	OFF	ON	OFF	OFF	OFF	OFF	ON	Adresse 161
ON	OFF	ON	OFF	OFF	OFF	ON	OFF	Adresse 162
ON	OFF	ON	OFF	OFF	OFF	ON	ON	Adresse 163
ON	OFF	ON	OFF	OFF	ON	OFF	OFF	Adresse 164
ON	OFF	ON	OFF	OFF	ON	OFF	ON	Adresse 165
ON	OFF	ON	OFF	OFF	ON	ON	OFF	Adresse 166
ON	OFF	ON	OFF	OFF	ON	ON	ON	Adresse 167
ON	OFF	ON	OFF	ON	OFF	OFF	OFF	Adresse 168
ON	OFF	ON	OFF	ON	OFF	OFF	ON	Adresse 169
ON	OFF	ON	OFF	ON	OFF	ON	OFF	Adresse 170

ADRESSEKONFIGURATION (DIP 3)								
SW 8	SW 7	SW 6	SW 5	SW 4	SW 3	SW 2	SW 1	Adresse
ON	OFF	ON	OFF	ON	OFF	ON	ON	Adresse 171
ON	OFF	ON	OFF	ON	ON	OFF	OFF	Adresse 172
ON	OFF	ON	OFF	ON	ON	OFF	ON	Adresse 173
ON	OFF	ON	OFF	ON	ON	ON	OFF	Adresse 174
ON	OFF	ON	OFF	ON	ON	ON	ON	Adresse 175
ON	OFF	ON	ON	OFF	OFF	OFF	OFF	Adresse 176
ON	OFF	ON	ON	OFF	OFF	OFF	ON	Adresse 177
ON	OFF	ON	ON	OFF	OFF	ON	OFF	Adresse 178
ON	OFF	ON	ON	OFF	OFF	ON	ON	Adresse 179
ON	OFF	ON	ON	OFF	ON	OFF	OFF	Adresse 180
ON	OFF	ON	ON	OFF	ON	OFF	ON	Adresse 181
ON	OFF	ON	ON	OFF	ON	ON	OFF	Adresse 182
ON	OFF	ON	ON	OFF	ON	ON	ON	Adresse 183
ON	OFF	ON	ON	ON	OFF	OFF	OFF	Adresse 184
ON	OFF	ON	ON	ON	OFF	OFF	ON	Adresse 185
ON	OFF	ON	ON	ON	OFF	ON	OFF	Adresse 186
ON	OFF	ON	ON	ON	OFF	ON	ON	Adresse 187
ON	OFF	ON	ON	ON	ON	OFF	OFF	Adresse 188
ON	OFF	ON	ON	ON	ON	OFF	ON	Adresse 189
ON	OFF	ON	ON	ON	ON	ON	OFF	Adresse 190
ON	OFF	ON	ON	ON	ON	ON	ON	Adresse 191
ON	ON	OFF	OFF	OFF	OFF	OFF	OFF	Adresse 192
ON	ON	OFF	OFF	OFF	OFF	OFF	ON	Adresse 193
ON	ON	OFF	OFF	OFF	OFF	ON	OFF	Adresse 194
ON	ON	OFF	OFF	OFF	OFF	ON	ON	Adresse 195
ON	ON	OFF	OFF	OFF	ON	OFF	OFF	Adresse 196
ON	ON	OFF	OFF	OFF	ON	OFF	ON	Adresse 197
ON	ON	OFF	OFF	OFF	ON	ON	OFF	Adresse 198
ON	ON	OFF	OFF	OFF	ON	ON	ON	Adresse 199
ON	ON	OFF	OFF	ON	OFF	OFF	OFF	Adresse 200
ON	ON	OFF	OFF	ON	OFF	OFF	ON	Adresse 201
ON	ON	OFF	OFF	ON	OFF	ON	OFF	Adresse 202
ON	ON	OFF	OFF	ON	OFF	ON	ON	Adresse 203
ON	ON	OFF	OFF	ON	ON	OFF	OFF	Adresse 204
ON	ON	OFF	OFF	ON	ON	OFF	ON	Adresse 205
ON	ON	OFF	OFF	ON	ON	ON	OFF	Adresse 206
ON	ON	OFF	OFF	ON	ON	ON	ON	Adresse 207
ON	ON	OFF	ON	OFF	OFF	OFF	OFF	Adresse 208
ON	ON	OFF	ON	OFF	OFF	OFF	ON	Adresse 209
ON	ON	OFF	ON	OFF	OFF	ON	OFF	Adresse 210
ON	ON	OFF	ON	OFF	OFF	ON	ON	Adresse 211
ON	ON	OFF	ON	OFF	ON	OFF	OFF	Adresse 212
ON	ON	OFF	ON	OFF	ON	OFF	ON	Adresse 213
ON	ON	OFF	ON	OFF	ON	ON	OFF	Adresse 214

ADRESSEKONFIGURATION (DIP 3)								
SW 8	SW 7	SW 6	SW 5	SW 4	SW 3	SW 2	SW 1	Adresse
ON	ON	OFF	ON	OFF	ON	ON	ON	Adresse 215
ON	ON	OFF	ON	ON	OFF	OFF	OFF	Adresse 216
ON	ON	OFF	ON	ON	OFF	OFF	ON	Adresse 217
ON	ON	OFF	ON	ON	OFF	ON	OFF	Adresse 218
ON	ON	OFF	ON	ON	OFF	ON	ON	Adresse 219
ON	ON	OFF	ON	ON	ON	OFF	OFF	Adresse 220
ON	ON	OFF	ON	ON	ON	OFF	ON	Adresse 221
ON	ON	OFF	ON	ON	ON	ON	OFF	Adresse 222
ON	ON	OFF	ON	ON	ON	ON	ON	Adresse 223
ON	ON	ON	OFF	OFF	OFF	OFF	OFF	Adresse 224
ON	ON	ON	OFF	OFF	OFF	OFF	ON	Adresse 225
ON	ON	ON	OFF	OFF	OFF	ON	OFF	Adresse 226
ON	ON	ON	OFF	OFF	OFF	ON	ON	Adresse 227
ON	ON	ON	OFF	OFF	ON	OFF	OFF	Adresse 228
ON	ON	ON	OFF	OFF	ON	OFF	ON	Adresse 229
ON	ON	ON	OFF	OFF	ON	ON	OFF	Adresse 230
ON	ON	ON	OFF	OFF	ON	ON	ON	Adresse 231
ON	ON	ON	OFF	ON	OFF	OFF	OFF	Adresse 232
ON	ON	ON	OFF	ON	OFF	OFF	ON	Adresse 233
ON	ON	ON	OFF	ON	OFF	ON	OFF	Adresse 234
ON	ON	ON	OFF	ON	OFF	ON	ON	Adresse 235
ON	ON	ON	OFF	ON	ON	OFF	OFF	Adresse 236
ON	ON	ON	OFF	ON	ON	OFF	ON	Adresse 237
ON	ON	ON	OFF	ON	ON	ON	OFF	Adresse 238
ON	ON	ON	OFF	ON	ON	ON	ON	Adresse 239
ON	ON	ON	ON	OFF	OFF	OFF	OFF	Adresse 240
ON	ON	ON	ON	OFF	OFF	OFF	ON	Adresse 241
ON	ON	ON	ON	OFF	OFF	ON	OFF	Adresse 242
ON	ON	ON	ON	OFF	OFF	ON	ON	Adresse 243
ON	ON	ON	ON	OFF	ON	OFF	OFF	Adresse 244
ON	ON	ON	ON	OFF	ON	OFF	ON	Adresse 245
ON	ON	ON	ON	OFF	ON	ON	OFF	Adresse 246
ON	ON	ON	ON	OFF	ON	ON	ON	Adresse 247
ON	ON	ON	ON	ON	OFF	OFF	OFF	Adresse 248
ON	ON	ON	ON	ON	OFF	OFF	ON	Adresse 249
ON	ON	ON	ON	ON	OFF	ON	OFF	Adresse 250
ON	ON	ON	ON	ON	OFF	ON	ON	Adresse 251
ON	ON	ON	ON	ON	ON	OFF	OFF	Adresse 252
ON	ON	ON	ON	ON	ON	OFF	ON	Adresse 253
ON	ON	ON	ON	ON	ON	ON	OFF	Adresse 254
ON	ON	ON	ON	ON	ON	ON	ON	Adresse 255

Tab. 21

Headquarters Italy Videotec S.p.A.

Via Friuli, 6 - I-36015 Schio (VI) - Italy

Tel. +39 0445 697411 - Fax +39 0445 697414

Email: info@videotec.com

Asia Pacific Videotec (HK) Ltd

Flat 8, 19/F. On Dak Industrial Building, No. 2-6 Wah Sing Street

Kwai Chung, New Territories - Hong Kong

Tel. +852 2333 0601 - Fax +852 2311 0026

Email: info.hk@videotec.com

France Videotec France SARL

Immeuble Le Montreal, 19bis Avenue du Québec, ZA de Courtaboeuf
91140 Villebon sur Yvette - France

Tel. +33 1 60491816 - Fax +33 1 69284736

Email: info.fr@videotec.com

Americas Videotec Security, Inc.

Gateway Industrial Park, 35 Gateway Drive, Suite 100
Plattsburgh, NY 12901 - U.S.A.

Tel. +1 518 825 0020 - Fax +1 518 825 0022

Email: info.usa@videotec.com - www.videotec.com



www.videotec.com

MNVCUPTMAXB_1511_DE



ULISSE MAXI

PTZ-устройство для активного наружного наблюдения за большими территориями

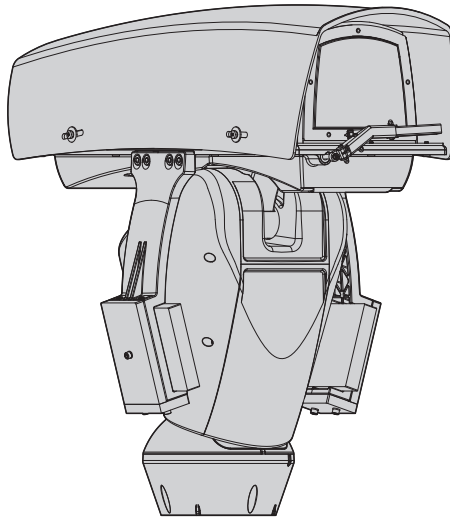

1 Информация о настоящем руководстве.....	7
1.1 Типографские обозначения.....	7
2 Примечания по авторскому праву и торговым маркам.....	7
3 Правила безопасности.....	7
4 Идентификация.....	10
4.1 Описание и назначение изделия.....	10
4.2 Маркировка изделия.....	10
4.2.1 Контроль маркировки.....	10
5 Версии.....	11
5.1 Светодиодные осветители.....	11
5.2 Германиевое стекло.....	11
6 Подготовка изделия к использованию.....	12
6.1 Меры безопасности перед использованием.....	12
6.2 Распаковка.....	12
6.3 Содержимое.....	12
6.4 Переработка в отходы в условиях безопасности материалов упаковки.....	12
6.5 Подготовительная работа перед установкой.....	13
6.5.1 Установка кронштейна.....	13
6.5.2 Прохождение кабелей.....	13
7 Сборка.....	14
7.1 Крепление крышки.....	14
7.2 Открытие корпуса.....	14
7.3 Монтаж телекамеры к объективам с двигателями.....	14
7.3.1 Характеристики телекамер.....	14
7.3.2 Установка объектива и телекамеры на внутренние салазки.....	15
7.3.3 Установка распорки Н-20 на внутренних салазках.....	16
7.3.4 Установка внутренних салазок.....	16
7.4 Описание платы футляра.....	17
7.4.1 Подключение телекамеры и моторизованных объективов.....	17
7.4.2 Регулировка напряжения питания двигателей объективов.....	18
8 Монтаж.....	19
8.1 Подключение к кабелям основания.....	19
8.2 Прикрепление основания к кронштейну.....	20
8.3 Описание платы разъемов.....	21
8.4 Подключение к линии питания.....	22
8.4.1 Подключение линии питания 24Vac.....	23
8.4.2 Подключение силовой линии в 120 В переменного тока и 230 В переменного тока.....	23
8.5 Подключение сигнальных кабелей.....	24
8.5.1 Подключение кабеля видео.....	24
8.5.2 Подключение к линии телеметрирования.....	25
8.5.3 Подключение входов сигналов тревоги, сумеречного выключателя и реле.....	26

8.6 Крепление верхнего корпуса	27
8.7 Установка противовесов	27
8.8 Установка светодиодных (LED) осветителей	28
8.8.1 Снятие противовесов	28
8.8.2 Установка осветителя на скобе	28
8.9 Подключение светодиодных (LED) осветителей	29
8.10 Подключение для синхронизации телекамеры со светодиодными (LED) осветителями.....	30
8.11 Пакетик с осушителем.....	30
8.12 Регулировка и режим включения светодиодных прожекторов	30
8.12.1 Описание светодиодного (LED) осветителя	30
8.12.2 Включение светодиодных прожекторов, используя внешний фоточувствительный выключатель.....	31
8.12.3 Включение светодиодных прожекторов, используя встроенный фотодатчик.....	31
8.12.4 Регулировка порога включения светодиодных (LED) осветителей	32
8.12.5 Регулировка мощности светодиодных (LED) осветителей.....	32
8.13 Фиксация щетки ветровое стекло.....	33
8.14 Конфигурация аппаратного обеспечения	34
8.14.1 Открытие конфигурационной дверцы.....	34
8.14.2 Конфигурация DIP1	34
8.14.3 Конфигурация DIP2	34
8.14.4 Конфигурация DIP3	35
8.14.4.1 Установка адреса	35
8.14.4.2 Конфигурация серийные линии связи.....	35
8.14.5 Конфигурация DIP4	35
8.14.6 Примеры установки устройства.....	36
8.14.6.1 Линия RS-485 RX.....	36
8.14.6.2 Линия RS-422 (RS-485-1 RX и RS-485-2 TX).....	36
8.14.6.3 Линия RS-485-1 приёма, линия RS-485-2 ретрансляции.....	36
8.14.6.4 Двухнаправленная линия RS-485 TX/RX.....	36
9 Включение	37
9.1 Первое включение	37
9.2 Список проверок	37
10 Конфигурация	38
10.1 Интерфейс OSM (On Screen Menu (Меню н экране))	38
10.1.1 С помощью OSM.....	38
10.1.1.1 Как пользоваться джойстиком.....	38
10.1.1.2 Как двигаться по меню.....	39
10.1.1.3 Как изменить параметры.....	39
10.1.1.4 Как изменить цифровые поля	40
10.1.1.5 Как изменить тексты	40
10.1.2 Конфигурации посредством OSM	42
10.1.3 Главное меню	42
10.1.4 Меню выбора языка.....	42
10.1.5 Меню параметров ZFI.....	42
10.1.5.1 Меню Титрования зон	43
10.1.5.2 Меню Каширования зон.....	44
10.1.6 Меню Последовательное Футляра	45
10.1.7 Меню Полярности.....	45
10.1.8 Меню движения	46
10.1.8.1 Меню ручного контроля	46

10.1.8.2 Меню ручного контроля (Рамки)	47
10.1.8.3 Меню Preset.....	47
10.1.8.4 Меню Preset (Изменяет Preset)	47
10.1.8.5 Меню Preset (Служебная Программа Preset)	48
10.1.8.6 Меню патрулирования (Patrol).....	48
10.1.8.7 Меню Autorap (автопанорамирование).....	48
10.1.8.8 Меню вызова движений	49
10.1.9 Меню визуализаций	49
10.1.10 Меню Цифровых I/O-Опции	49
10.1.10.1 Меню тревог.....	50
10.1.10.2 Меню связи	50
10.1.10.3 Меню моющей установки	51
10.1.11 Меню по умолчанию	51
10.1.12 Меню информации	51
11 Комплектующие	52
11.1 Установка мойки	52
11.1.1 Подключение мощного оборудования	52
11.2 Настенное крепление.....	53
11.3 Кронштейн для крепления параллельно потолку	53
11.4 Блок питания с функцией контроля осветителей.....	53
12 Инструкции по обычному функционированию	54
12.1 Отображение состояния наводки.....	54
12.2 Сохранение Preset	54
12.3 Вызов положения Preset (Scan)	54
12.4 Вызов положения Home.....	54
12.5 Включение Patrol.....	54
12.6 Включение автопанорамирования	55
12.7 Активация стеклоочистителя (Wiper)	55
12.8 Активирует систему мойки (Washer)	55
12.9 Активация светодиодного (LED) осветителя.....	55
12.10 Перезагрузка узла	55
12.11 Специальные команды.....	56
12.12 Специальные конфигурации	57
13 Техобслуживание.....	58
13.1 Замена предохранители.....	58
14 Уборка	58
14.1 Очистка стекла и пластмассовых частей	58
14.2 Очистка стеклянного окошка с содержанием германия.....	58
15 Вывоз в отходы	58
16 Устранение неисправностей.....	59
17 Технические параметры.....	61
17.1 Общие характеристики	61
17.2 Технические характеристики.....	61
17.3 Окно кожуха.....	61
17.4 Электрические характеристики	61

17.5 Видео	62
17.6 Связь.....	62
17.7 Протоколы	62
17.8 Интерфейс ввода-вывода	62
17.9 Объективы	62
17.10 Среда	62
17.11 Сертификаты	62
18 Технические чертежи	63
A Приложение - Таблица адресов	66

1 Информация о настоящем руководстве

Перед установкой и использованием этого оборудования внимательно прочтите всю предоставленную документацию. Всегда держите руководство под рукой, чтобы к нему можно было обратиться в будущем.

1.1 Типографские обозначения



ОПАСНОСТЬ!

Повышенная опасность.

Опасность удара электрическим током. Если не указано иным образом, отключите питание, прежде чем приступить к выполнению операций, если не указано иным образом, отключите питание.



ОПАСНОСТЬ!

Горячая поверхность.

Следует избегать контакта. Горячие поверхности могут причинить поражения человеку в случае контакта.



ОПАСНОСТЬ!

Опасность механической природы.

Риск раздавливания или отрезания.



ПРЕДУПРЕЖДЕНИЕ!

Средняя опасность.

Эта операция очень важна для правильной работы системы. Просим внимательно прочитать приведенную процедуру и выполнить ее указанным способом.



INFO

Описание характеристик системы.

Рекомендуется внимательно для выполнения следующих фаз.

2 Примечания по авторскому праву и торговым маркам

Упомянутые название компаний и продукции являются торговыми марками или зарегистрированными торговыми марками, принадлежащими соответствующим компаниям.

3 Правила безопасности



ПРЕДУПРЕЖДЕНИЕ! Система электропитания, к которой подключен прибор, должен быть оснащена биполярный автоматический выключатель защиты макс. 20А. Этот выключатель выбирается из перечисленных в списке. Минимальное расстояние между автоматический выключатель контактами должно быть 3mm. Выключатель должен иметь защиту против пробоя тока на землю (дифференциальную) и сверхток (магнитотермический).



ПРЕДУПРЕЖДЕНИЕ! Опасные движущиеся компоненты. Не приближать пальцы или другие части тела.



ПРЕДУПРЕЖДЕНИЕ! Следует использовать только кронштейны или принадлежности, рекомендуемые для монтажа.



ПРЕДУПРЕЖДЕНИЕ! Во избежание пожароопасности, заменяйте плавкие предохранители такими же, аналогичного типа и значения тока. Замена плавких предохранителей должна выполняться только квалифицированным персоналом.



ПРЕДУПРЕЖДЕНИЕ! Установка типа TNV-1. Не подключайте к системам SELV.



ПРЕДУПРЕЖДЕНИЕ! Для снижения опасности пожара пользуйтесь исключительно кабелями, имеющими сертификат UL Listed или CSA, имеющими разъемы не менее 0,14mm² (26AWG).

- Производитель снимает с себя какую-либо ответственность за возможный ущерб, вызванный использованием не по назначению упомянутого в данном руководстве оборудования. Также сохраняется право изменять содержание без предварительного извещения. При тщательном сборе документации, содержащейся в настоящем руководстве, были сделаны все необходимые проверки. Производитель, однако, не может взять на себя какую-либо ответственность, связанную с его использованием. Это относится к любому лицу или обществу, вовлеченному в создание и производство данного руководства.

- Перед началом любой операции, убедитесь, что электропитание отключено.
- Не использовать кабели со следами повреждений или старения.
- Ни в коем случае не вносить изменений и не выполнять подключений, не предусмотренных данным руководством. Использование оборудования не по назначению, может привести к серьёзным рискам и опасно, как для персонала, так и для системы.
- Используйте только оригинальные запасные части. Номера для оригинальных запасных частей может привести к пожару, электрический разряд или других опасностей.
- Перед монтажом проверить, что поставляемый материал соответствует требуемым техническим спецификациям, проверив этикетки маркировки (4.2 Маркировка изделия, страница 10).
- Категория установки (называемая также категория перенапряжения) указывает уровни скачков напряжения сети, которым подвержен прибор. Категория зависит от места установки и присутствия устройств защиты от перенапряжений. Устройство для промышленных условий, подключенное к основным ответвлениям линии питания, относится к категории установки III. Если речь идет о данном случае, требуется уменьшение до категории II. Этого можно достичь с помощью разделительного трансформатора с заземленным экраном между первичной и вторичной обмоткой или с помощью устройств защиты от перенапряжений (SPD) с UL listed, подключенных между фазой и нейтралью и между нейтралью и землей. Устройства SPD с маркировкой UL используются для повторяющегося подавления кратковременных перенапряжений и при следующих номинальных условиях функционирования: Тип 2 (Устройства SPD, постоянно подключенные к сети питания, для установки со стороны загрузки рабочего устройства); Номинальный ток разряда (I_n) минимум 20кА. Например, можно использовать: FERRAZ SHAWMUT, ST23401PG-CN, ST240SPG-CN, указанные для 120/240Vac, ($I_n=20кА$). Максимальное расстояние между установкой и переходником составляет 5м.
- Это устройство предназначено для несъемной установки и постоянного подключения на здании или на подходящей конструкции. Перед выполнением любой операции устройство должно быть установлено и подключено на постоянной основе.
- Электросистема должна быть оснащена рубильником, который можно легко определить и использовать в случае необходимости.
- Вывод заземления, присутствующий в изделии, должен быть постоянно подключен к земле.
- Подключите устройство к источнику питания, который соответствует маркировке. Прежде чем приступить к установке, убедитесь, что линия электропередачи правильно секционирована. Напряжение питания не должно превышать предельных ($\pm 10\%$).
- Питание должно подаваться от отдельного источника типа SELV, 24Vac, 8A, идущего от трансформатора с двойной изоляцией, зарегистрированного в списке UL, соответственно защищенного на выходе.
- Устройство устанавливается так, чтобы доступ к нему мог иметь только технический персонал или монтажник, поскольку из-за наличия подвижных частей существует опасность травмирования в результате движения этих подвижных компонентов.
- Наклейте этикетку Опасные Подвижные Компоненты рядом с устройством (Рис. 4, страница 12).
- Не используйте прибор в присутствии воспламеняющихся веществ.
- Для подключения линии питания используйте специальную соединительную коробку (UPTJBUL). Для получения дополнительной информации смотреть руководство по эксплуатации и установки изделия.

- Не разрешайте пользоваться прибором детям или посторонним лицам.
- Техобслуживание прибора должно выполняться только квалифицированным персоналом. Во время техобслуживания оператор подвержен риску поражения электрическим током и другим опасностям.
- Используйте только комплектующие, указанные изготовителем. Любое изменение, выполненное без разрешения изготовителя, ведёт к потере гарантии.
- Подключите к земле коаксиальный кабель.
- Перед подключением всех кабелей сигнала проверьте, чтобы узел был соответственно подключен к заземлению.
- Если устройство необходимо снять с установки, всегда в последнюю очередь отсоединяйте кабель заземления.
- Примите соответствующие меры для предупреждения повреждений аппаратуры электростатическими разрядами.
- Узел реализован для подключения посредством трехжильного кабеля. Для правильного подключения контура заземления придерживайтесь указаний, содержащихся в данном руководстве.
- Обращайтесь с прибором осторожно, сильные механические воздействия могут его повредить.
- Обратите особое внимание на изоляцию и расстояния между линией питания и всеми другими кабелями, в том числе устройствами защиты от молний.
- Можно транспортировать устройство только с максимальной аккуратностью. Резкие остановки, перепады уровней и сильные столкновения могут приводить к повреждениям устройства или травмированию пользователя.

4 Идентификация

4.1 Описание и назначение изделия

ULISSE MAXI - надежная и эффективная PTZ-камера, разработанная для обеспечения непрерывного и активного наружного наблюдения за большими территориями и работы в суровых климатических условиях.

Данная модель может размещать самые большие из представленных на рынке объективы с приводом общим весом до 8 кг и позволяет управлять ими.

Таким образом, одно устройство может обеспечить охват в 360° всей области наблюдения.

Для получения детального изображения даже в ночное время предоставляются модели со светодиодными осветителями с инфракрасным или белым светом.

Надежная механическая конструкция и мощные моторы этого PTZ-устройства разработаны таким образом, чтобы обеспечить максимальную устойчивость к высокой рабочей нагрузке, вибрациям и температурам от -10°C до +60°C.

Система ULISSE PLUS оснащена оптическими датчиками, которые обеспечивают точность управления и позиционирования при любых условиях эксплуатации.

Устройство может быть оснащено стеклоочистителем для удаления капель дождя и частиц пыли с переднего стекла; имеется широкий выбор канистр с насосом омывателя разных объемов и с разным напором.

Доступны модели с тепловизорами.

4.2 Маркировка изделия



На поворотные устройства наклеены этикетки, соответствующие маркировке ЕС.



Рис. 1

На этикетке указаны:

- Идентификационный код модели (Расширенный штрих-код 3/9).
- Питание (Volt).
- Частота (Hertz).
- Потребление тока (Ампер).
- Степень защиты (IP).
- Серийный номер.

4.2.1 Контроль маркировки

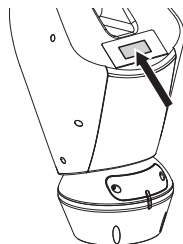
До начала установки проверьте, изучив для этого маркировочные этикетки, чтобы поставленный материал соответствовал специальным требованиям.

Ни в коем случае не вносить изменений и не выполнять подключений, не предусмотренных данным руководством. Использование оборудования не по назначению, может привести к серьезным рискам и опасно, как для персонала, так и для системы.

5 Версии

5.1 Светодиодные осветители



Версия со светодиодными (LED) осветителями может получать питание только 24Vac.

Поворотное устройство может быть укомплектовано кронштейном для установки 2 светодиодных (LED) осветителей VIDEOTEС для ночного видения (осветители не входят).



Рис. 2



За дополнительной информацией обратитесь к соответствующей главе (8.8 Установка светодиодных (LED) осветителей, страница 28).

5.2 Германиевое стекло

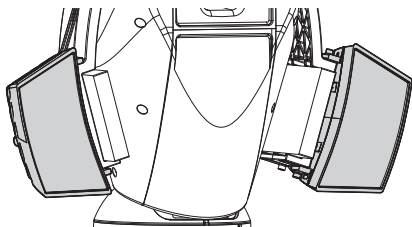
Версия с окошком из германия предназначена для приложений с тепловизионными камерами.



Рис. 3

6 Подготовка изделия к использованию



Любое изменение, выполненное без разрешения изготовителя, ведёт к потере гарантии.

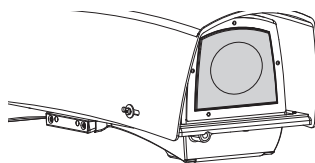

Устройство не должно быть демонтировано или подделано. Исключение составляют лишь те, которые касаются операций по сборке и техническому обслуживанию, предусмотренные в данном руководстве.

6.1 Меры безопасности перед использованием



Оборудование включает в себя подвижные компоненты. Проверить, чтобы блок был установлен в зоне, недоступной во время нормальной работы оборудования. Поместить специальную табличку, поставляемую вместе с оборудованием, на хорошо видимом месте в непосредственной близости к нему.



Рис. 4

6.2 Распаковка

При поставке изделия убедитесь в том, что упаковка не повреждена и не имеет явных признаков падений или царапин.

В случае видимых повреждений упаковки немедленно свяжитесь с поставщиком.

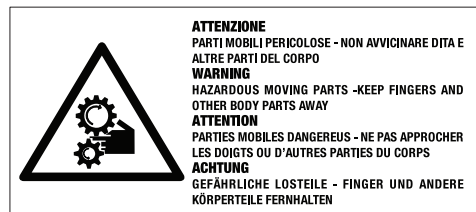
Храните упаковку на случай, если необходимо отправка изделия для ремонта.



Распаковывайте крышку устройства осторожно, чтобы не повредить футляр.

6.3 Содержимое

Убедитесь в том, что содержимое будет соответствовать списку материалов, приведённому ниже:

- Устройство позиционирования
- Основание питания
- Упаковка аксессуары:
 - Серийный адаптер
 - Последовательный кабель-удлиннитель
 - Ключи шестигранные
 - Распорки
 - Распорки (не присутствует в версиях с интегрированной телекамерой)
 - Этикетка
 - Хомутики
 - Силиконовая оболочка
 - Уплотнители уменьшения для кабельных муфт.
 - Учебник инструкции
 - Пластина фиксации для пакетика с осушителем
 - Пакетик с осушителем
 - Набор винтов
- Упаковка противовесов:
 - Скоба для крепления светодиодных (LED) осветителей (присутствует в версиях со светодиодными (LED) осветителями)
 - Противовесы
 - Опоры для противовесов
 - Солнцезащитный козырек

6.4 Переработка в отходы в условиях безопасности материалов упаковки

Материалы упаковки полностью состоят из рекуперированного материала. Техник по установке должен переработать их в отходы в соответствии с порядком дифференцированного сбора или, в любом случае, в соответствии действующими правилами в стране использования.

В случае возврата некачественной продукции, рекомендуем использовать первоначальную оригинальную упаковку для транспортировки.

6.5 Подготовительная работа перед установкой

6.5.1 Установка кронштейна



Для установок, подверженным вибрациям, используйте только кронштейн с установкой на поручни.

В наличии разные типы кронштейнов (11 Комплектующие, страница 52). Выберите наиболее подходящий для монтажа и следуйте всем указаниям, приведенным в данном разделе.



Обратите особое внимание на системы крепления аппаратуры. Система креплений должна выдерживать вес, не менее чем 4-кратно превышающий вес самой аппаратуры, в том числе поворотного устройства, объектива и телекамеры.



Устройство должно устанавливаться в вертикальном положении. Каждое альтернативное расположение может ухудшить характеристики аппаратуры.



Не устанавливайте устройство перевернутым.

6.5.2 Прохождение кабелей



Соединительные кабели не должны быть доступны извне. Во избежание случайного выскальзывания из-за избыточного веса кабели должны быть как следует прикреплены к поддержке.



Используемые кабели должны соответствовать типу установки.

Уложите кабели внутри кронштейна так, чтобы они выходили наружу примерно на 50см.



Рис. 5

7 Сборка

7.1 Крепление крышки

Прикрепите крышку к футляру с помощью прилагающихся 4 винтов и 4 шайбы пары предоставляются.

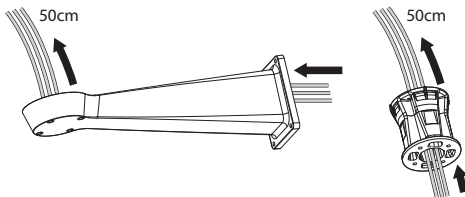

Рис. 6

7.2 Открытие корпуса

Раскрутите винты, предохраняющие от утечки, по бокам и поднимите верхнюю часть кожуха.

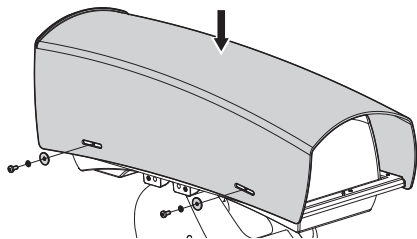

Рис. 7

i По завершении операций по установке и прокладке кабеля закройте устройство.

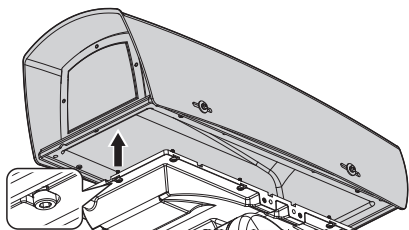

Рис. 8

i Первыми затяните центральные винты, как показано на рисунке.

7.3 Монтаж телекамеры к объективам с двигателями

Установка телекамеры и соответствующих объективов выполняется силами заказчика.

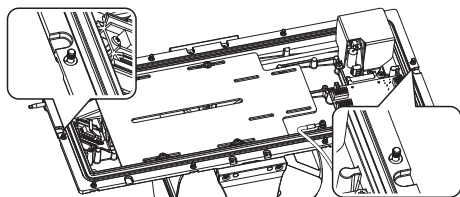
7.3.1 Характеристики телекамер



Исправная работа оборудования в указанном диапазоне температуры гарантируется только в том случае, если используются видеокамера и объектив для пределов температуры от -10°C до $+60^{\circ}\text{C}$.

- Напряжение питания телекамеры должно быть 12Vdc.
- Максимальный ток, потребляемый камерой, должен быть меньше указанного ниже значения: 800мА.
- Сигнал видео на выходе из телекамеры должен быть смешанного типа с амплитудой 1Vpp (синхронизация отриц.).

7.3.2 Установка объектива и телекамеры на внутренние салазки

! Необходимо изолировать корпус телекамеры от крепежных салазок, чтобы предотвратить помехи на сигнале видео.

! Максимальный допустимый вес для телекамеры и объектива не должен превышать 7,6kg.

Подключите телекамеру (02) к объективу M20 (01).

Прикрепите L-образную алюминиевую скобку (03) к телекамере с помощью нейлоновой шайбы (04) и винта 1/4" (05).



Рис. 9

Расположите объектив на салазках (02), установив пластмассовую распорку (01). Прикрепите с помощью нейлоновой шайбы (03) и винта 1/4" (04).

Если необходимо, используйте дополнительные распорки для правильного позиционирования телекамеры и объективов.

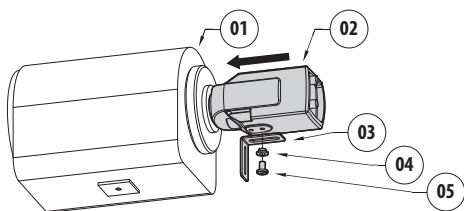

Рис. 10

Закрепите алюминиевую пластину (01) на салазках с помощью винтов и соответствующих шайб (02).

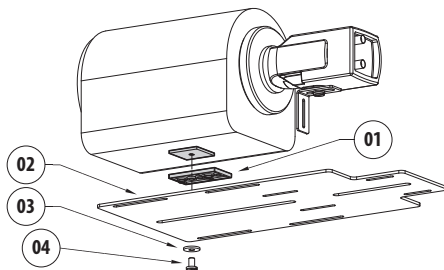

Рис. 11

Закрепите скобу в форме L винтом.

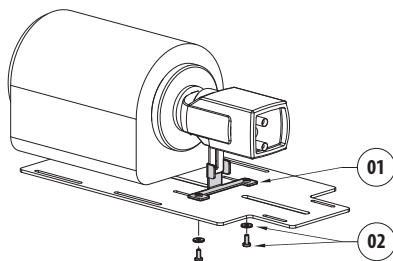

Рис. 12

7.3.3 Установка распорки Н-20 на внутренних салазках

Можно прикрепить распорку Н-20 (02) к объективу. Подключите телекамеру и прикрепите L-кронштейн (Рис. 9, страница 15). Вставьте пластмассовую распорку (01) нужной толщины и зафиксируйте ее с помощью шайбы и винта (03).

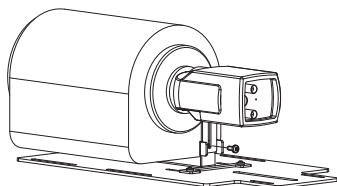

Рис. 13

Расположите объектив с распоркой на внутренних салазках (01) и прикрепите с помощью прилагающихся шайб и винтов (02).

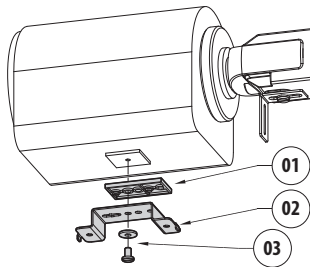

Рис. 14

Завершите фиксацию как показано на рисунках (Рис. 11, страница 15 и Рис. 12, страница 15).

7.3.4 Установка внутренних салазок

Переместите внутренние салазки с уже прикрепленными объективом и телекамерой в нужное положение и зафиксируйте с помощью прилагающихся винтов и шайб.

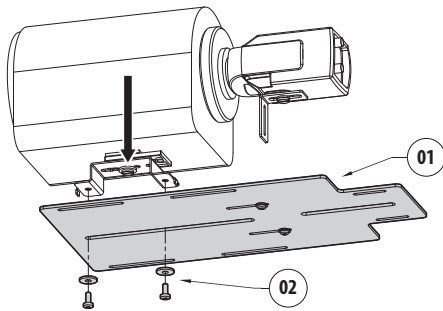

Рис. 15

7.4 Описание платы футляра

ОПИСАНИЕ ПЛАТЫ	
Разъём/Клемма	Функция
CN1	Разъём BNC, видеосигнал от камеры
CN2	Разъём для управления моторизованными объективами
CN3	Разъём для потенциометров моторизованных объективов
CN6	Последовательный разъём для управления телекамерой
CN7	Источник питания для камеры, свободный контакт для активации Day/Night режима телекамеры, линии дополнительные
DIP1	Выбор напряжения питания объективов

Таб. 1

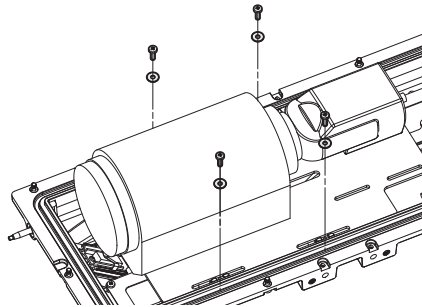

Рис. 16

7.4.1 Подключение телекамеры и моторизованных объективов

⚠ Соединения, показанные ниже, должны выполняться только опытным персоналом; при этом необходимо соблюдать все особенности прокладки кабелей и питания устройств.

Электронная плата разработана так, чтобы управлять телекамерами с моторизованными объективами, оснащенными или нет потенциометрами для контроля достигнутого положения.

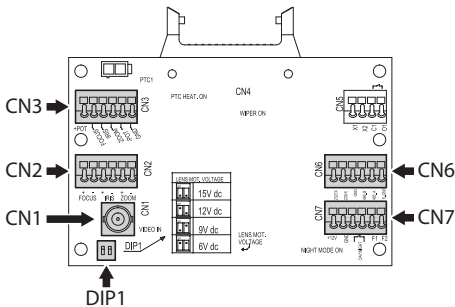
⚠ До выполнения подключений проверьте, чтобы напряжения, поступающие с платы, были в пределах, предусмотренных для аппаратуры.

РАЗЪЕМ ДЛЯ ПОДКЛЮЧЕНИЯ ТЕЛЕКАМЕРЫ К МОТОРИЗОВАННЫМ ОБЪЕКТИВАМ

Напряжение	Ток	Описание
+12V	800mA макс.	Источник питания для камеры
+5V	15mA макс.	Питание потенциометров объективов
От 6В постоянного тока до 15В постоянного тока (регулирующийся)	200mA макс. (Focus + Увеличение + Диафрагма)	Питание двигателей объективов

Таб. 2

Объективы с двигателями инверсии полярности:

Выполните подключения, как показано на рисунке..



Рис. 17 CN2.

Объективы с двигателями на общей жиле: Выполните подключения, как показано на рисунке..

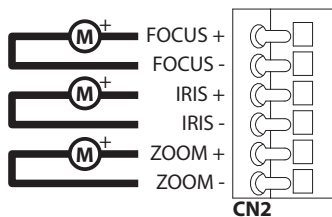

Рис. 18 CN2.

Потенциометры: Выполните подключения, как показано на рисунке..

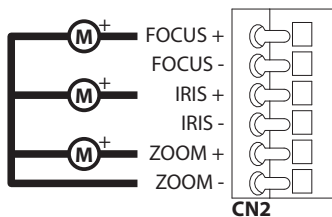

Рис. 19 CN3.

Камера: Выполните подключения, как показано на рисунке..

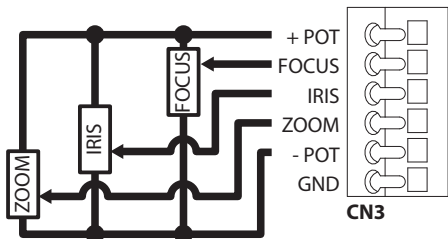

Рис. 20

Для активации контроля телекамеры обратитесь к соответствующей главе (10.1.6 Меню Последовательное Футляра, страница 45).

7.4.2 Регулировка напряжения питания двигателей объективов

Перед подачей напряжения на поворотное устройство установите напряжение питания объективов с помощью DIP1 (7.4 Описание платы футляра, страница 17).

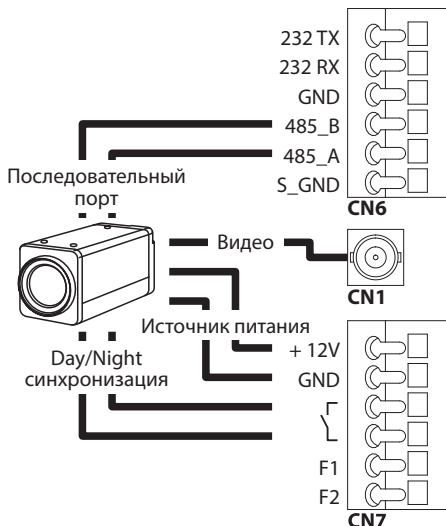
РЕГУЛИРОВКА НАПЯЖЕНИЯ ПИТАНИЯ ДВИГАТЕЛЕЙ ОБЪЕКТИВОВ		
SW1	SW2	Напряжение
OFF	OFF	15В постоянного тока
ON	OFF	12В постоянного тока
OFF	ON	9В постоянного тока
ON	ON	6В постоянного тока

Таб. 3

8 Монтаж

! Ни в коем случае не вносить изменений и не выполнять подключений, не предусмотренных данным руководством. Несоблюдение инструкций, предоставленных в руководстве и касающихся соединений, может привести к созданию серьезных опасных ситуаций для персонала и установки.

! Не заменять уже имеющуюся на оборудовании кабельпроводку. Несоблюдение данной инструкции может привести к созданию серьезных опасных ситуаций для персонала и установки, а также к аннулированию гарантии.

i В случае использования набора для очистки стекла держатель насадки должен устанавливаться перед установкой поворотного устройства и прокладкой кабеля. За дополнительной информацией обращаться к руководству по эксплуатации соответствующего набора.



Рис. 21

i В нижнем колпаке присутствует пакетик с осушителем, предотвращающий образование влаги в основании и в области плат разъемов. Снимите пакет перед установкой.

8.1 Подключение к кабелям основания

Уложите кабели в кабельные муфты и, удерживая основание на расстоянии около 20см от кронштейна Затяните кабеледержатели. Кабельные муфты подходят к кабелям, имеющим диаметр от 5мм до 10мм.

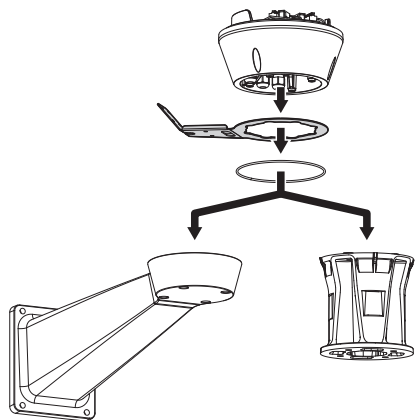

Рис. 22

! Будьте осторожны при установке. Момент затяжки: 5Нм.

i Для кабелей диаметром от 3 до 7мм используйте специальные резиновые прокладки, входящие в набор поставки.

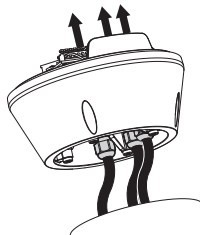

Рис. 23

8.2 Прикрепление основания к кронштейну

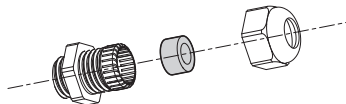

Используйте винты и шайбы, поставляемые с основанием.

После установки прокладки (01) прикрепите основание (02) к кронштейну (03), используя винты, зубчатые шайбы (05) и кольца для винтов (06).



Рис. 24



Рис. 25

Выровняйте 3 отметки на основании с отметками, присутствующими на кронштейнах, как показано на следующем рисунке.

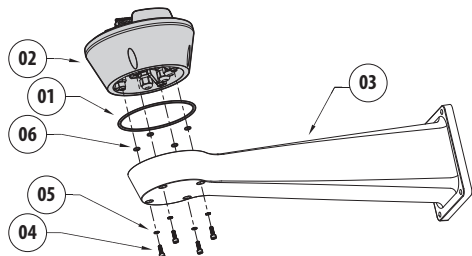

Рис. 26

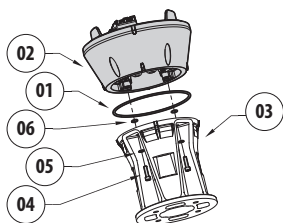

Применить резьбового фиксатора отверстия винтов (Loctite 243®).

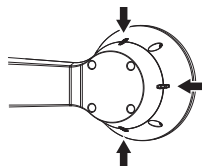

Будьте осторожны при установке. Момент затяжки: 6Нм.

Таб. 4

8.3 Описание платы разъемов

ОПИСАНИЕ ПЛАТЫ РАЗЪЕМОВ	
Разъём/Компонент	Функция
J6	Питание платы
J7	Кабелей сигнала
J4	RS-232
F1	Плавкий предохранитель
F2	Плавкий предохранитель

Таб. 5 Стандартную версию.



Рис. 27 Стандартную версию.

ОПИСАНИЕ ПЛАТЫ РАЗЪЕМОВ	
Разъём/Компонент	Функция
J6	Питание платы
J7	Кабелей сигнала
J4	RS-232
F1	Плавкий предохранитель
F2	Плавкий предохранитель

Таб. 6 Версия со LED осветителями.

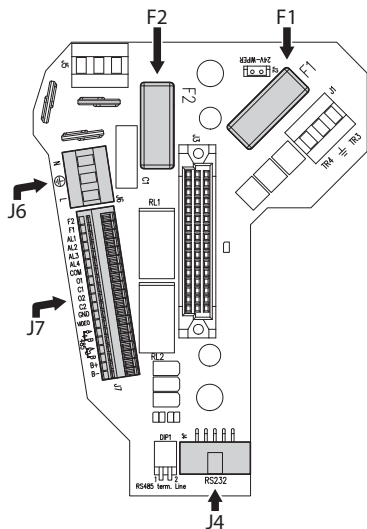

Рис. 28 Версия со LED осветителями.

8.4 Подключение к линии питания

В зависимости от версии, на устройство может подаваться различное напряжение питания. Значение напряжения питания указано на идентификационной табличке изделия (4.2 Маркировка изделия, страница 10).

⚠ Выполнять электрические подключения при отсутствии питания и с открытым разъединяющим устройством.

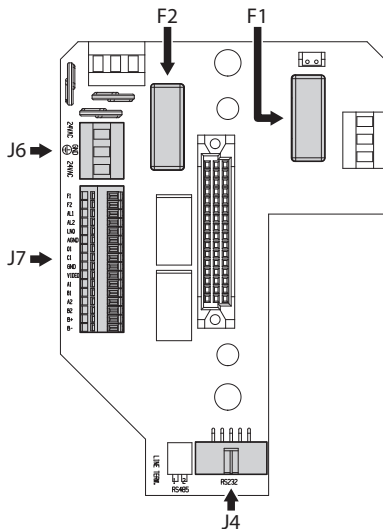
⚠ В момент монтажа убедитесь в том, что характеристики подаваемого питания соответствуют характеристикам, требуемым устройством.

⚠ Убедитесь, что источник и кабель питания обладают необходимыми характеристиками.

⚠ Провод заземления должен быть длиннее двух других примерно на 10mm, с целью предотвращения случайного отсоединения по причине растяжения кабеля.

⚠ Кабель питания должен быть покрыт силиконовой оболочкой (01), имеющейся в комплекте. Силиконовая оболочка крепится с помощью зажима (02).



Рис. 29

8.4.1 Подключение линии питания 24Vac

Отрезать по размеру кабели и реализовать соединения. Подключите питающую линию к следующей клемме: J6.

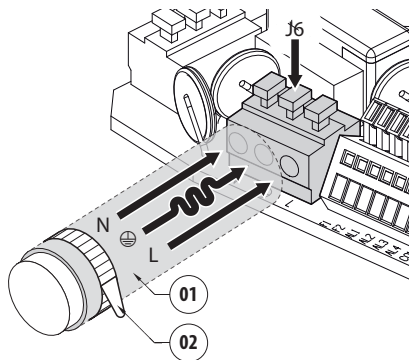

Рис. 30 Стандартную версию.



Рис. 31 Версия со LED осветителями.

Подключите кабели питания, как описано в таблице ниже.

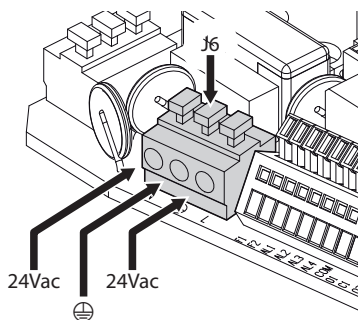
ПОДКЛЮЧЕНИЕ К ЛИНИИ ПИТАНИЯ	
Цвет	Клеммы
Источник питания 24 В переменного тока	
Определяется установщиком	24Vac
Определяется установщиком	24Vac
Желтый/Зеленый	⊕

Таб. 7

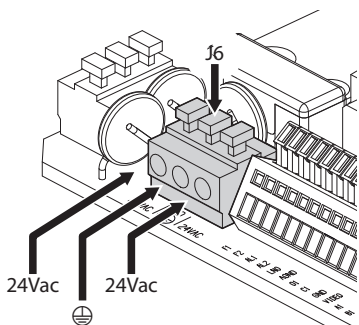
8.4.2 Подключение силовой линии в 120 В переменного тока и 230 В переменного тока

Отрезать по размеру кабели и реализовать соединения. Подключите питающую линию к следующей клемме: J6.



Рис. 32 Стандартную версию.

Подключите кабели питания, как описано в таблице ниже.

ПОДКЛЮЧЕНИЕ К ЛИНИИ ПИТАНИЯ	
Цвет	Клеммы
Источник питания 230 В переменного тока	
Синий	N (Нейтраль)
Коричневый	L (Фаза)
Желтый/Зеленый	⊕
Питание 120Vac	
Синий	N (Нейтраль)
Коричневый	L (Фаза)
Желтый/Зеленый	⊕

Таб. 8

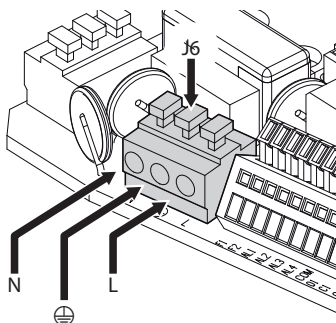
8.5 Подключение сигнальных кабелей

! Все сигнальные кабели должны быть сгруппированы под одним хомутиком.



Рис. 33

8.5.1 Подключение кабеля видео

! ПРЕДУПРЕЖДЕНИЕ! Для снижения опасности пожара пользуйтесь исключительно кабелями, имеющими сертификат UL Listed или CSA, имеющими разделы не менее $0,14\text{mm}^2$ (26AWG).

! Установка типа кабельного телевидения CDS (Cable Distribution System). Не подключайте к системам SELV.

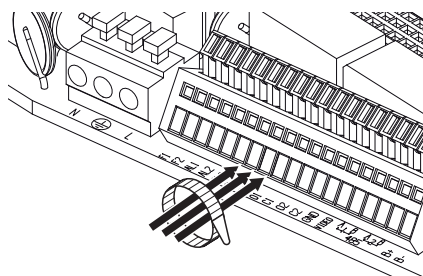
! Подключите соответственно экран и центральный кабель к клеммам GND и VIDEO. Клетки подходят к кабелям, имеющим сечение между $0,5\text{mm}^2$ (20AWG) и $0,08\text{mm}^2$ (28AWG).



Рис. 34 Стандартную версию.



Рис. 35 Версия со LED осветителями.

8.5.2 Подключение к линии телеметрирования

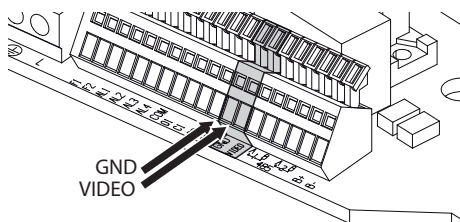
⚠ ПРЕДУПРЕЖДЕНИЕ! Установка типа TNV-1. Не подключайте к системам SELV.

⚠ ПРЕДУПРЕЖДЕНИЕ! Для снижения опасности пожара пользуйтесь исключительно кабелями, имеющими сертификат UL Listed или CSA, имеющими разъемы не менее $0,14\text{mm}^2$ (26AWG).

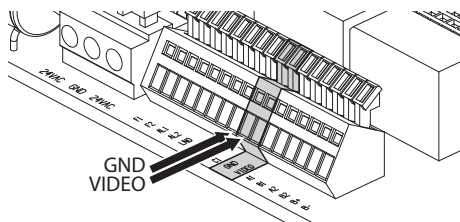
Устройство предусматривает два последовательные линии связи RS-485 и один последовательную линию RS-232 (только для обновления прошивки).

Линии телеуправления могут быть конфигурированы различными способами, согласно положениям двухрядных переключателей 10 и 9 переключателя последовательных линий и адресу (8.14.4.2 Конфигурация серийные линии связи, страница 35).

Последовательные линии RS-485



Рис. 36 RS-485. Стандартную версию.



Рис. 37 RS-485. Версия со LED осветителями.

ПОДКЛЮЧЕНИЕ К ЛИНИИ ТЕЛЕМЕТРИРОВАНИЯ

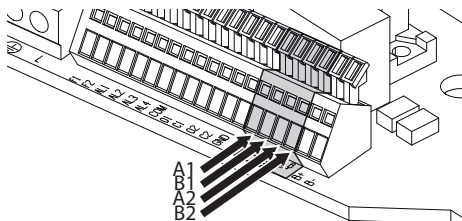
Клеммы	Описание
A1-B1	Линия RS-485 (1)
A2-B2	Линия RS-485 (2)

Таб. 9

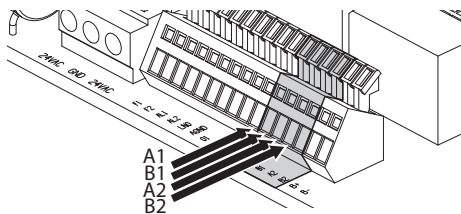
Последовательная линия RS-232



Рис. 38 RS-232.

8.5.3 Подключение входов сигналов тревоги, сумеречного выключателя и реле

⚠ ПРЕДУПРЕЖДЕНИЕ! Установка типа TNV-1. Не подключайте к системам SELV.

⚠ ПРЕДУПРЕЖДЕНИЕ! Для снижения опасности пожара пользуйтесь исключительно кабелями, имеющими сертификат UL Listed или CSA, имеющими разделы не менее 0,14mm² (26AWG).

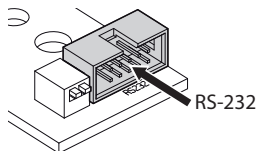
Стандартную версию



Рис. 39 Вход сигнала тревоги.



Рис. 40 Реле.

ПОДКЛЮЧЕНИЕ ВХОДОВ АВАРИЙНЫХ СИГНАЛОВ И РЕЛЕ	
Клеммы	Описание
AL1, AL2, AL3, AL4 е COM	Аварийные входы сигнала тревоги, контролируемые в напряжении, отнесенные к общей клемме COM
F1-F2	Зарезервировано для использования в будущем
O1-C1 е O2-C2	Свободные контакты выхода, активируемые сигналом тревоги или командой пользователя

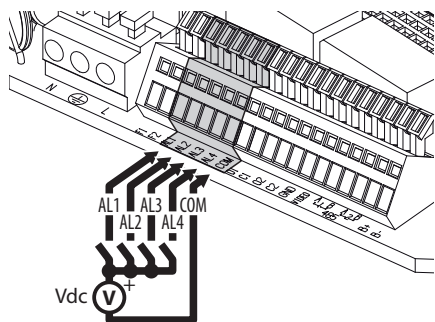
Таб. 10 Стандартную версию.

Версия со LED осветителями

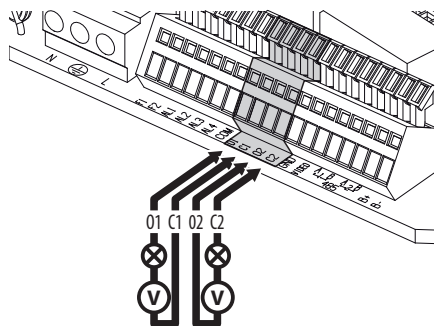

Рис. 41 Входы сигнала тревоги и сумеречный выключатель.



Рис. 42 Реле.

ПОДКЛЮЧЕНИЕ ВХОДОВ СИГНАЛОВ ТРЕВОГИ, СУМЕРЕЧНОГО ВЫКЛЮЧАТЕЛЯ И РЕЛЕ

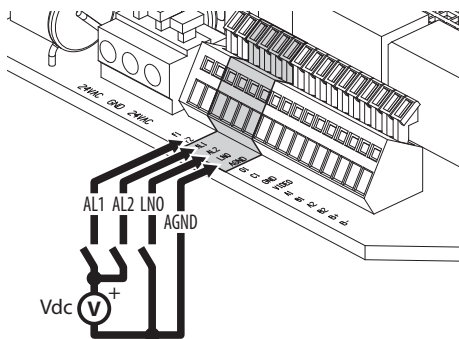
Клеммы	Описание
AL1, AL2 е AGND	Аварийные входы, контролируемые в напряжении, отнесенные к общей клемме AGND
F1-F2	Зарезервировано для использования в будущем
LNO е AGND	Сумеречный выключатель (сухой контакт)
O1-C1	Свободные контакты выхода, активируемые сигналом тревоги или командой пользователя

Таб. 11 Версия со LED осветителями.

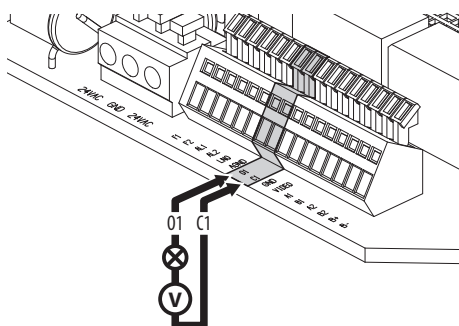
8.6 Крепление верхнего корпуса

Прикрепите верхний корпус (01) к основанию (02) с помощью крепежных винтов (03), укомплектованных прокладками (04). Проверьте присутствие и хорошее состояние уплотнителя основания (05).

⚠ Будьте осторожны при установке. Момент затяжки: 4Нм.



Рис. 43



Рис. 44

i Существует единственное положение крепления между основанием и верхним корпусом. Выровняйте боковые выступы для правильного расположения.

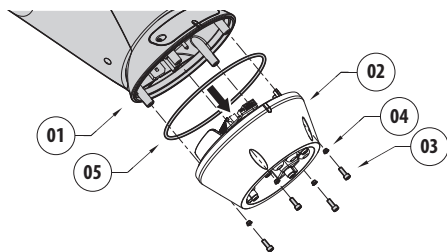
8.7 Установка противовесов

Прикрепите противовесы к футляру с помощью винтов и шайб.

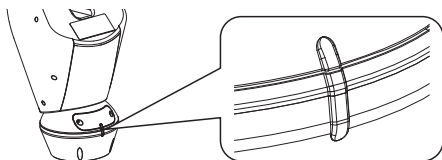

Рис. 45

⚠ Применить резьбового фиксатора отверстия винтов (Loctite 243®).

⚠ Будьте осторожны при установке. Момент затяжки: 16Нм.

8.8 Установка светодиодных (LED) осветителей

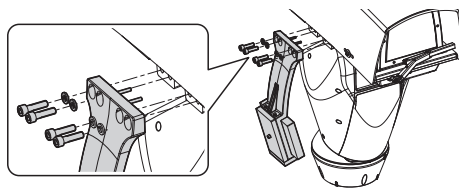
! Для правильного функционирования необходимо всегда устанавливать оба осветителя.

i На поворотном устройстве можно устанавливать только осветители VIDEOTEC.

8.8.1 Снятие противовесов

Отвинтить винты и снять внешние противовесы.



Рис. 46

8.8.2 Установка осветителя на скобе

Найдите передние отверстия на кронштейне противовеса.

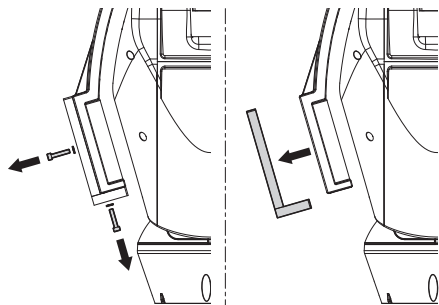

Рис. 47

Расположите крепления осветителя (01) на креплениях скобы (02).

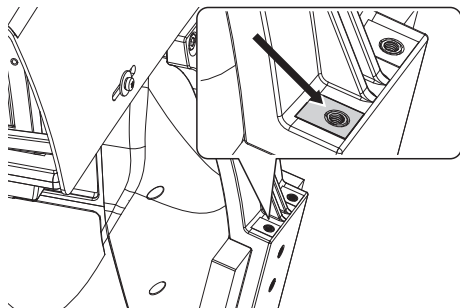

Рис. 48

Закрутите ранее снятые винты с шайбами.

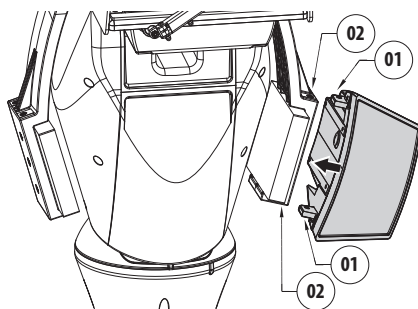

Рис. 49

! Будьте осторожны при установке. Момент затяжки: 6Нм.

8.9 Подключение светодиодных (LED) осветителей

Снимите 2 пробки M12. Завинтите 2 кабельные муфты и соответствующие уплотнительные кольца, входящие в комплект поставки.

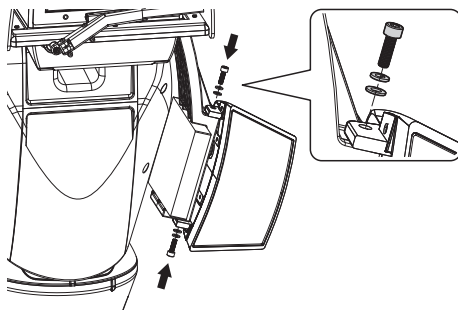

Рис. 50



Чтобы не поставить под угрозу безопасность и функционирование узла, не оставляйте излишки кабеля снаружи.

Рис. 51

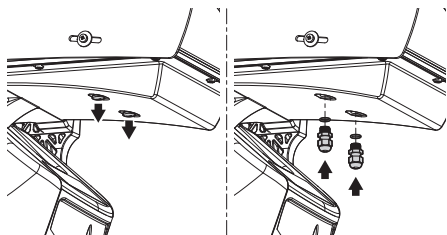

Рис. 52

Подключите кабели, как показано на рисунке.

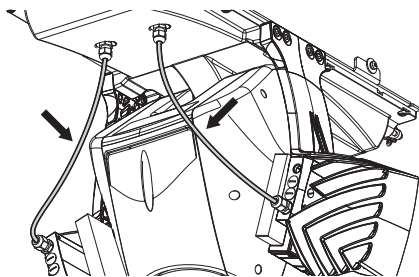

Рис. 53

ПОДКЛЮЧЕНИЕ СВЕТОДИОДНЫХ (LED) ОСВЕТИТЕЛЕЙ			
Осветитель левый		Осветитель правый	
Ссылка на плату	Цвет кабеля	Ссылка на плату	Цвет кабеля
WH	белый	WH	белый
BK	Черный	BK	Черный
A1	Зеленый	A2	Зеленый
B1	Красный	B2	Красный

Таб. 12

8.10 Подключение для синхронизации телекамеры со светодиодами (LED) осветителями

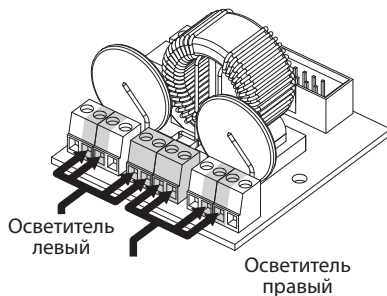
Телекамер ZFI укомплектованных инфракрасным фильтром: Подключите вход коммутации режима День/Ночь телекамеры к соединителю Ночного режима (свободный контакт) как показано на рисунке.



Рис. 54

8.11 Пакетик с осушителем

Положить пакетика с осушителем (01) в положение, указанном на рисунке, вынув их из прозрачной упаковки и согнув вдвое. Прикрепите пакетики с помощью пластин (02) и прилагающихся винтов (03).

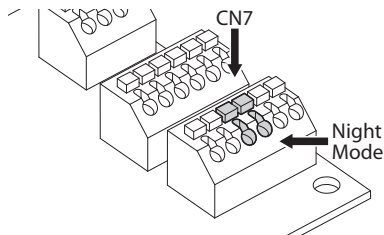

Рис. 55

8.12 Регулировка и режим включения светодиодных прожекторов

После завершения регулировки левый осветитель (MASTER) синхронизует и контролирует осветитель справа (SLAVE).

Сумеречный выключатель считывает окружающее освещение и контролирует включение и отключение осветителей, когда яркость достигает заданного пользователем уровня.

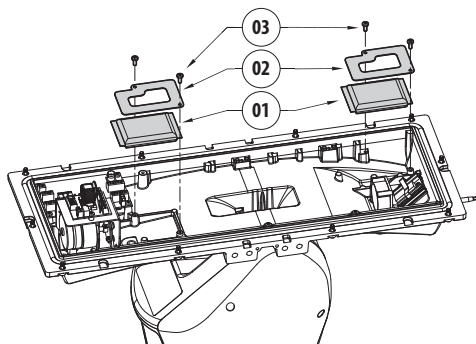
Сигнал переключения Day/Night отправлен на видеокамеру при включении светодиодных осветителей (8.10 Подключение для синхронизации телекамеры со светодиодами (LED) осветителями, страница 30).

8.12.1 Описание светодиодного (LED) осветителя

! Для обеспечения правильного и безопасного функционирования осветителя не откручивать прозрачный винт датчика освещенности.

- **Сумеречный датчик:** Измеряет уровень яркости.
- **Кабель:** Питание и управление.
- **Регулятор порога включения:** Потенциометр позволяет регулировать уровень чувствительности для включения осветителя.
- **Регулятор мощности инфракрасных:** Потенциометр регулировать мощность осветителя.



Рис. 56

8.12.2 Включение светодиодных прожекторов, используя внешний фоточувствительный выключатель

Выполните следующие действия:

- Подключите сумеречный выключатель к клеммам: LN O/AGND (8.5.3 Подключение входов сигналов тревоги, сумеречного выключателя и реле, страница 26).
- Отрегулировать левый осветитель (MASTER):
 - **Порог включения:** Установить значение на минимум (8.12.4 Регулировка порога включения светодиодных (LED) осветителей, страница 32).
 - **Мощность инфракрасных осветителей:** Установить значение в зависимости от потребностей (8.12.5 Регулировка мощности светодиодных (LED) осветителей, страница 32).
- Регулировка правого осветителя (SLAVE):
 - **Порог включения:** Установите значение на максимум (8.12.4 Регулировка порога включения светодиодных (LED) осветителей, страница 32).
 - **Мощность инфракрасных осветителей:** Установить значение на минимум (8.12.5 Регулировка мощности светодиодных (LED) осветителей, страница 32).
- Присвойте значение Внешняя позиции Датчик IR меню параметров ZFI (10.1.5 Меню параметров ZFI, страница 42).

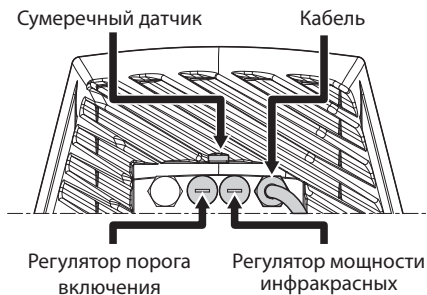
```

ZFI CAMERA SETTINGS
-----
1>ZOOM                :    30x
3 IR PROBE           :    EXT.
4 ZONE TITLING       :    >
5 ZONE MASKING       :    >
```

Рис. 57

8.12.3 Включение светодиодных прожекторов, используя встроенный фотодатчик

Для синхронизации LED осветителями и телекамеры с внешним сумеречным датчиком необходимо:

- Отрегулировать левый осветитель (MASTER):
 - **Порог включения:** Установить значение в зависимости от потребностей (8.12.4 Регулировка порога включения светодиодных (LED) осветителей, страница 32).
 - **Мощность инфракрасных осветителей:** Установить значение в зависимости от потребностей (8.12.5 Регулировка мощности светодиодных (LED) осветителей, страница 32).
- Регулировка правого осветителя (SLAVE):
 - **Порог включения:** Установите значение на максимум (8.12.4 Регулировка порога включения светодиодных (LED) осветителей, страница 32).
 - **Мощность инфракрасных осветителей:** Установить значение на минимум (8.12.5 Регулировка мощности светодиодных (LED) осветителей, страница 32).
- Присвойте значение Внутренняя позиции Датчик IR меню параметров ZFI (10.1.5 Меню параметров ZFI, страница 42).

```

ZFI CAMERA SETTINGS
-----
1>ZOOM                :    30x
3 IR PROBE           :    INT.
4 ZONE TITLING       :    >
5 ZONE MASKING       :    >
```

Рис. 58

8.12.4 Регулировка порога включения светодиодных (LED) осветителей

⚠ Правый осветитель всегда должен быть отрегулирован на максимальную яркость.



Рис. 59

Осветитель представляет собой встроенный сумеречный датчик, обеспечивающий автоматическое включение и выключение при заданных условиях освещенности.

Регулировка сумеречного датчика выполнена на фабрике и настроена на заранее установленный уровень освещения, подходящего для большинства установок (около 50 люкс). Если нужно отрегулировать иным способом порог срабатывания, отвинтите пробку, установленную на задней поверхности осветителя и отрегулируйте с помощью отвертки.

Поворот триммера по часовой стрелке вызывает преждевременную коммутацию в ночной режим (переключение на более высокое значение освещенности). Поворот триммера против часовой стрелки вызывает запаздывание коммутации в ночной режим (переключение на более низкое значение освещенности).

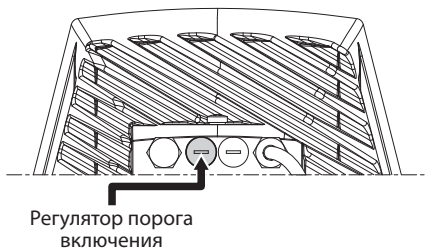

Рис. 60

Подождите условий освещенности, подходящих для включения осветителя. Медленно поворачивайте триммер до включения светодиодов, установленных на боку триммера. Как только превышает порог срабатывания (LED включенный), слегка поверните в обратном направлении.

⚠ По завершении регулировок проверьте, чтобы заглушка была соответственно затянута, гарантируя герметичность изделия.

8.12.5 Регулировка мощности светодиодных (LED) осветителей

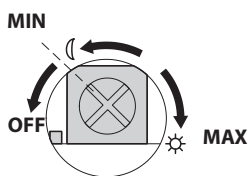
⚠ Правый осветитель всегда должен быть отрегулирован на минимальную мощность.

Осветитель регулируется на фабрике так, чтобы давать максимальную мощность. Если вы не служите, чтобы осветить далекие детали или изображение получается засвеченным из-за избыточной освещенности, отрегулируйте мощность, чтобы ее уменьшить и получить энергосбережение.



Рис. 61

Отвинтите герметичную заглушку. Поверните триммер по часовой стрелке, чтобы увеличить мощность инфракрасного осветителя и против часовой стрелки, чтобы уменьшить.

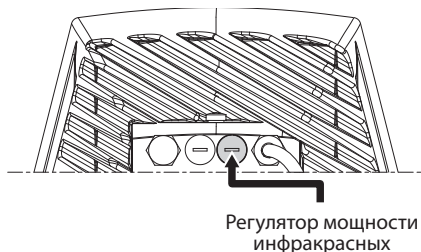

Рис. 62

⚠ По завершении регулировок проверьте, чтобы заглушка была соответственно затянута, гарантируя герметичность изделия.

8.13 Фиксация щетки ветровое стекло

Введите щетку вал ветровое стекло

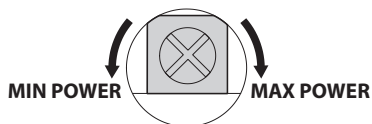
Установите щетку в исходное положение



Рис. 63

Прикрепите все с помощью зубчатой шайбы и гайки.



Рис. 64

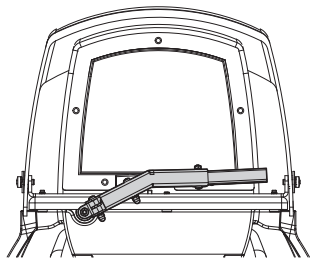

Правильная настройка должна позволять щетке вернуться в исходное положение после удара о пластину корпуса.

8.14 Конфигурация аппаратного обеспечения

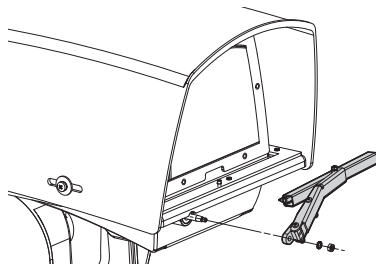
8.14.1 Открытие конфигурационной дверцы

Перед подачей питания на устройство, необходимо правильно его конфигурировать с помощью dip-переключателей, установленных на конфигурационной дверце. Откройте дверцу, отвинтив винты, как показано на рисунке.



Рис. 65

DIP-выключатели такие, как представлено на рисунке.

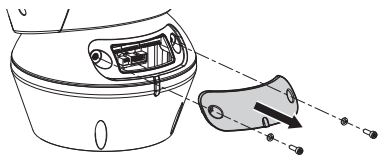

Рис. 66

i По завершении операций по установке и прокладке кабеля закройте устройство.

8.14.2 Конфигурация DIP1

i Рычажок переключателя в положении вверх представляет значение 1 (ON). Рычажок вниз - значение 0 (OFF).

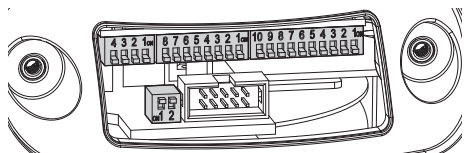
Переключатель 1 используется для обновления микропрограммы.

Переключатели 4, 3 и 2 используются для установки скорости сообщения устройства.



Рис. 67

КОНФИГУРАЦИЯ DIP1					
Описание	SW 4	SW 3	SW 2	SW 1	Baud rate
Регулировка скорости двоичной передачи	OFF	OFF	OFF	-	300 baud
	ON	OFF	OFF	-	600 baud
	OFF	ON	OFF	-	1200 baud
	ON	ON	OFF	-	2400 baud
	OFF	OFF	ON	-	4800 baud
	ON	OFF	ON	-	9600 baud
	OFF	ON	ON	-	19200 baud
Обновления прошивки	-	-	-	ON	Программирование активировано
	-	-	-	OFF	Программирование деактивировано

Рис. 68

8.14.3 Конфигурация DIP2

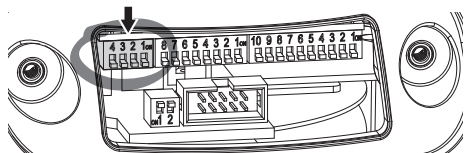
i Рычажок переключателя в положении вверх представляет значение 1 (ON). Рычажок вниз - значение 0 (OFF).

Наводку можно контролировать через различные протоколы.



Рис. 69

КОНФИГУРАЦИЯ DIP2								
Протокол	SW 8	SW 7	SW 6	SW 5	SW 4	SW 3	SW 2	SW 1
PTZ Manager ¹	OFF	OFF	OFF	OFF	OFF	OFF	OFF	OFF
MACRO (VIDEOTEC)	OFF	OFF	OFF	OFF	OFF	ON	ON	ON
PANASONIC	OFF	OFF	OFF	ON	OFF	ON	OFF	OFF
PELCO D	OFF	OFF	OFF	OFF	ON	OFF	OFF	ON
AMERICAN DYNAMICS	OFF	OFF	OFF	OFF	ON	ON	ON	OFF
VISTA	OFF	OFF	OFF	ON	OFF	OFF	ON	ON

Таб. 13 ¹ Конфигурация: MACRO (VIDEOTEC), 115200 бод, Адрес 1. Эта опция не требует установки DIP-switch (DIP1, DIP3).

Таб. 14

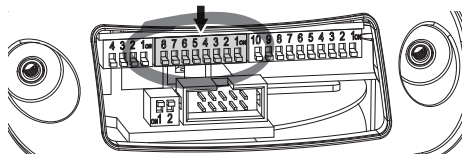
8.14.4 Конфигурация DIP3

i Рычажок переключателя в положении вверх представляет значение 1 (ON). Рычажок вниз - значение 0 (OFF).



Рис. 70

8.14.4.1 Установка адреса

Выключатели от 1 до 8 используются для конфигурации адреса блока (от 1 до 255).

Выбор адреса происходит в зависимости от двоичного кода (А Приложение - Таблица адресов, страница 66).

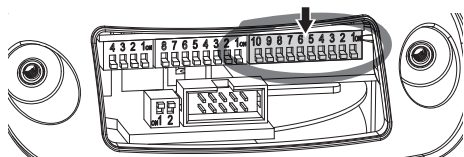
8.14.4.2 Конфигурация серийные линии связи

Устройство предусматривает два последовательные линии связи RS-485

Выключатели 10 и 9 используются для конфигурации последовательных линий.

КОНФИГУРАЦИЯ DIP3		
Описание	SW 10	SW 9
Однонаправленная связь на линии RS-485-1.	OFF	OFF
Связь в дуплексном режиме (full duplex) в соответствии со стандартом RS-422.	OFF	ON
Каскадное подсоединение нескольких устройств. Сигнал восстанавливается каждым узлом.	ON	OFF
Двунаправленная связь, полудуплексная связь (half-duplex) на линии RS-485-1.	ON	ON

Таб. 15

i За дополнительной информацией обратитесь к соответствующей главе (8.14.6 Примеры установки устройства, страница 36).

8.14.5 Конфигурация DIP4

i Настройка этого DIP выполняется в обратном порядке, чем ранее выполненные. Рычажок переключателя в положении вверх представляет значение 0 (OFF). Рычажок вниз - значение 1 (ON).

В плате имеются два переключателя, использованные для конфигурации терминала (120 Ohm) серийных линий.



Рис. 71

Каждое блок, которое находится в конце линии, должно использоваться со специальным переключателем во избежание создания отражений и деформаций сигнала.

Переключатели 1 и 2 установлены соответственно в конце последовательных линий RS-485-1 и RS-485-2.

КОНФИГУРАЦИЯ DIP4			
Серийная линия	SW 2	SW 1	Описание
Линия RS-485-1	–	ON	Завершено
	–	OFF	Не завершенная
Линия RS-485-2	ON	–	Завершено
	OFF	–	Не завершенная

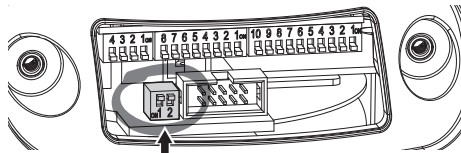
Таб. 16

8.14.6 Примеры установки устройства

8.14.6.1 Линия RS-485 RX

Линия RS-485-1 работает в соответствии с установками, отрегулированными с помощью dip-переключателя Адреса, Baud rate и Протокола.

Серийная линия RS-485-2 не используется.



Рис. 72

⚠ ПРЕДУПРЕЖДЕНИЕ! Установка типа TNV-1. Не подключайте к системам SELV.

8.14.6.2 Линия RS-422 (RS-485-1 RX и RS-485-2 TX)

Эта установка позволяет сообщение в дуплексной связи (full duplex) в соответствии со стандартом RS-422. Поэтому используются линии RS-485-1 и RS-485-2.

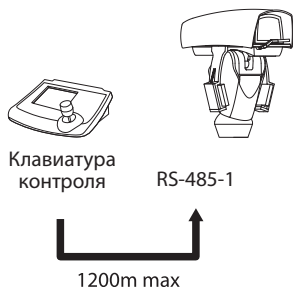

Рис. 73

i Данная функция имеется только при двунаправленных протоколах (пример: PELCO, AMERICAN DYNAMICS, VIDEOTEC MACRO, искл.).

8.14.6.3 Линия RS-485-1 приёма, линия RS-485-2 ретрансляции

Эта установка позволяет соединять несколько устройств каскадом. Сигнал создаётся каждым устройством, позволяя значительно увеличивать общее расстояние.

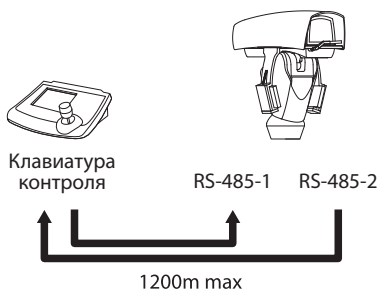

Рис. 74

i Эта конфигурация используется только для однонаправленных протоколов.

8.14.6.4 Двунаправленная линия RS-485 TX/RX

Этот установки позволяет получить двунаправленное сообщение полудуплексной связи (half-duplex) на линии RS-485-1.

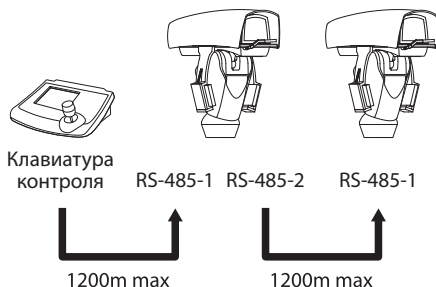
Серийная линия RS-485-2 не используется.



Рис. 75

i Данная функция имеется только при двунаправленных протоколах (пример: PELCO, AMERICAN DYNAMICS, VIDEOTEC MACRO, искл.).

9 Включение

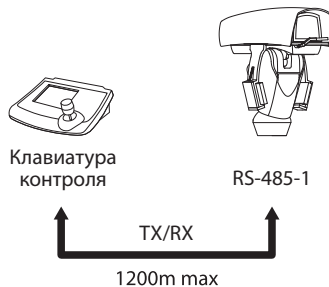

Проверить, что прибор, и другие компоненты установки закрыты таким образом, чтобы предотвратить контакт с компонентами под напряжением.



Во время нормального функционирования поверхность осветителя может нагреваться до высоких температур. Избегайте прямого контакта и расположите аппаратуру в месте, недоступном для неуполномоченного персонала. Для выполнения любых работ по техобслуживанию выключите осветительное устройство и оставьте остывать не менее 10 минут.



Не находитесь рядом с прибором, если на него подается питание. Воздействуйте на устройство только при отключенном питании.



Проверьте, чтобы все компоненты были закреплены хорошо и надежно.



Процедура автоматического предварительного подогрева (De-Ice) может быть активирована всегда, когда устройство включается при температуре окружающей среды ниже 0°C. Процедура служит для обеспечения правильного функционирования прибора даже при низких температурах. Долгота меняется от 60 до 120 минут в соответствии с условиями. !da duplicazione! (от 60 минут до 105 минут).

Чтобы включить прибор, подключить электропитание.

Чтобы выключить прибор, следует его обесточить.

9.1 Первое включение

При первом включении всегда целесообразно проверить правильность конфигурации устройства.

Перед подачей питания снять защитную дверцу DIP-переключателей и установить на ON язычок переключателя обновления программно-аппаратного обеспечения (8.14.2 Конфигурация DIP1, страница 34).

Подайте питание на устройство. Через несколько секунд можно будет проверить на экране заданную конфигурацию..

По завершении проверки выключите устройство и снова опустите рычажок переключателя обновления микропрограммы.

Закройте дверцу и снова подайте питание на устройство.

9.2 Список проверок



Если одна из проверок не проходит тест (ERR), свяжитесь с центром технической поддержки. Надпись OFF означает что поворотное устройство не снабжено описанной опцией.

В фазу включения устройство отображает список проверок, которые должны выполняться перед переходом к нормальному функционированию.

STARTUP

```

-----
TEST FLASH           : OK
HOMING PROCEDURE    : OK
ZFI SEARCH          : OK
IO EXPANDER         : OFF
IR360 STATE         : OFF
  
```

Рис. 76

10 Конфигурация

10.1 Интерфейс OSM (On Screen Menu (Меню н экране))

10.1.1 С помощью OSM

Во время нормальной работы блока можно подключить OSM для выбора и конфигурации продвинутых функций. Во вопросам получения дополнительной информации обращайтесь к руководству по эксплуатации используемой клавиатуры и к соответствующей главе (12.11 Специальные команды, страница 56).

Выйти из OSM с помощью Zoom Wide (Zoom-).

i Меню конфигурируется автоматически и динамически в зависимости от модели поворотного устройства.

10.1.1.1 Как пользоваться джойстиком

Все операции меню выполняются с использованием джойстика.



Рис. 77 Панорамирование и вертикальное перемещение.



Рис. 78 Zoom Wide и Zoom Tele.

i В случае использования клавиатуры с джойстиком на двух осях, пользуйтесь кнопками Zoom Wide и Zoom Tele для отправки команд выхода и подтверждения.

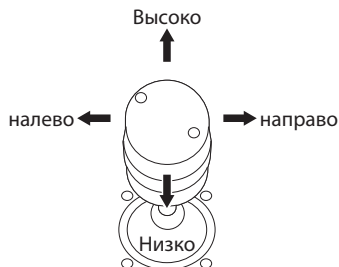
10.1.1.2 Как двигаться по меню

Каждая рабочая область OSM представляет список параметров или подменю, которые могут быть выбраны оператором. Для пролистывания различных параметров перемещайте курсор путем перемещения джойстика (вверх и вниз).

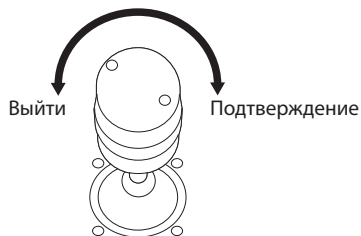

Рис. 79

Символ > в конце строки указывает на наличие специфического подменю. Для его активации достаточно подтвердить позицию меню. Для выхода из подменю пользуйтесь функцией Выйти (Zoom Wide).

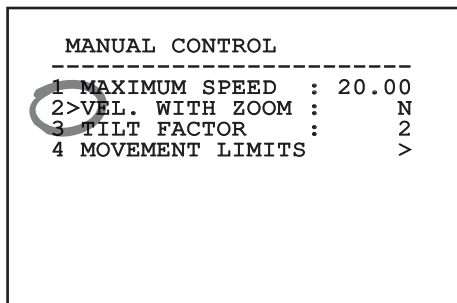

Рис. 80

10.1.1.3 Как изменить параметры

Сместите курсор в соответствии с параметром, который желаете изменить, и подтвердите. Поле начнёт мигать, указывая, что находится в режиме изменений. При нажатии на джойстик (вверх и вниз) будет показан возможный выбор.

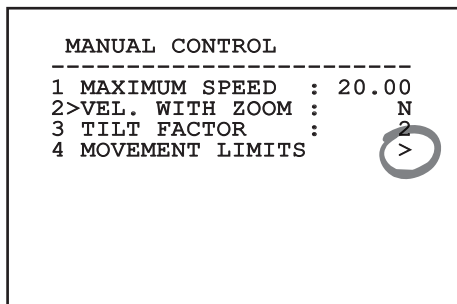

Рис. 81

После определения нужного выбора подтвердите.

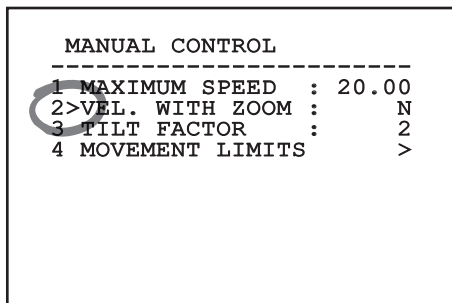

Рис. 82

Поле перестанет мигать в подтверждение выбранного.

10.1.1.4 Как изменить цифровые поля

Сместите курсор в соответствии с параметром, который желаете изменить, и подтвердите.

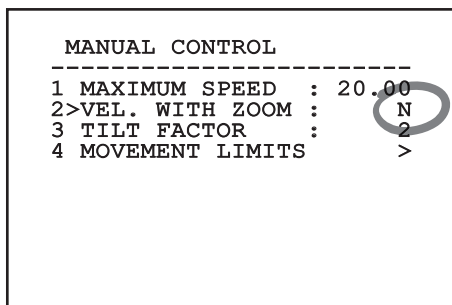

Рис. 83

Первая цифра изменяемого числового поля мигает и последняя строка экрана показывает допустимые пределы поля. Двигайтесь по полю (влево и направо) и замените знак или цифровое значение (высокое и низкое).

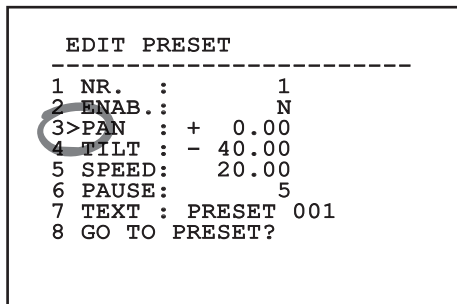

Рис. 84

По подтверждению результата подтвердите. Курсор вернется в положение слева, а измененная цифра перестанет мигать. Поле будет форсировано на допустимые минимум или максимум, если выполнена попытка ввода непредусмотренного значения.

10.1.1.5 Как изменить тексты

Сместите курсор в соответствии с параметром, который желаете изменить, и подтвердите.

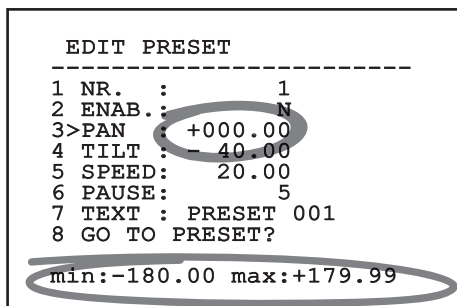

Рис. 85

Появится рабочая область изменения текста. Символ стрелки находится под изменяемым символом, в то время как курсор > встает слева от выбранного символа.

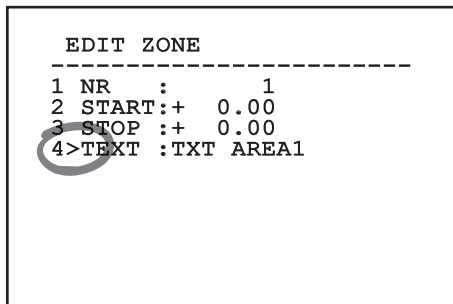

Рис. 86

Можно перемещаться по меню при помощи джойстика.

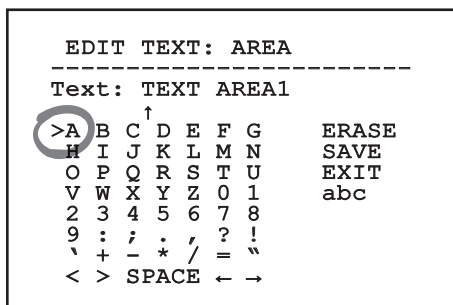

Рис. 87

Команда подтверждение (Зум теле) вводит желаемый символ.

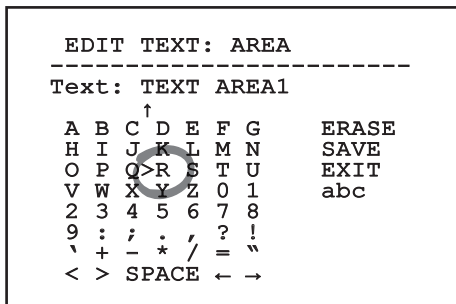

Рис. 88

Использовать:

- **ERASE:** Удаление целой строки текста.
- **SAVE:** Сохраните новый текст перед выходом из меню.
- **EXIT:** Выход из меню.
- **abc:** Выводит строчные буквы.

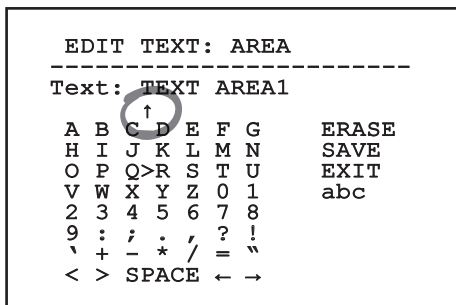

Рис. 89

Для выхода из меню можно пользоваться также командой Zoom Wide.

10.1.2 Конфигурации посредством OSM

Ниже будут показаны экранные изображения, необходимые для конфигурации изделия.

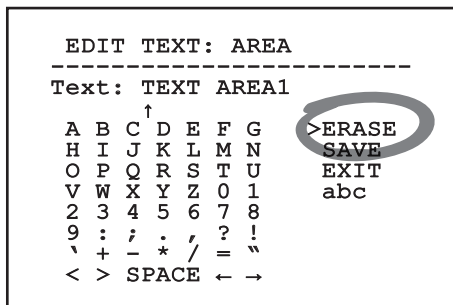
10.1.3 Главное меню

В главном меню можно получить доступ к конфигурации устройства.



Рис. 90

Меню конфигурируется автоматически и динамически в зависимости от модели поворотного устройства.

10.1.4 Меню выбора языка

Меню позволяет выбрать нужный язык.

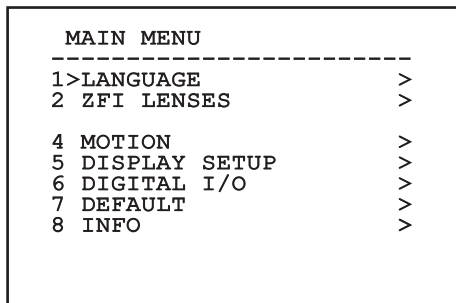

Рис. 91

10.1.5 Меню параметров ZFI

- Увеличение:** Устанавливает максимальное число увеличений, которые может выполнить моторизованный объектив.
- Общий провод:** Если активирован, управляет моторизованными объективами с общим проводом, альтернативно - объективами с реверсионной полярностью.
- Зонд IR:** Указывает на наличие сумеречного выключателя для управления функцией Day/Night приводного объектива. Имеются три опции:
 - Off: Не активировано переключение Day/Night (день/ночь)
 - Внутренняя: Сумеречный выключатель для переключения Day/Night находится внутри осветителей.
 - Внешняя: Сумеречный выключатель для переключения Day/Night следует подсоединить к клемме LNO.
- Area Titling:** Позволяет вход в подменю для управления титрованием зон.
- Каширование зон:** Позволяет войти в подменю для управления кашированием зон.
- Последовательный порт Футляра:** Позволяет войти в подменю для управления последовательным портом футляра.
- Полярность:** Позволяет войти в подменю для управления полярностью двигателей Zoom, Focus и Iris.

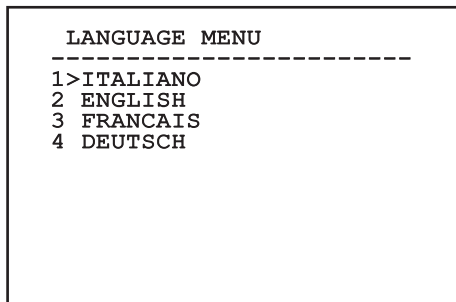

Рис. 92

10.1.5.1 Меню Титрования зон

Эта функция позволяет установить до восьми зон (различных размеров) с возможностью титрования.

Позволяет настроить следующие параметры:

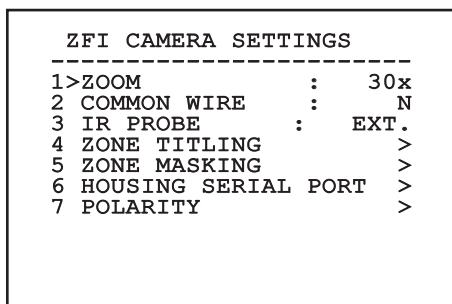
Число: Выбирает зону для изменения.

Включение: Активирует изображение на экране сообщения, связанного с достигнутой зоной.

Start: Устанавливает начальное положение зоны.

Stop: Устанавливает конечное положение зоны

Текст: Изменяет текст, который отображается при движении внутри зоны.



Рис. 93

Пример: Для активации титрование зоны 1, когда устройство находится между +15° и +45°, необходимо:

- Активировать озаглавливание зон, устанавливая S в качестве значения позиции Активация.
- Выберите 1 как значение параметра Nr.
- Установите +015.00 как значение параметра пуска.
- Установите +045.00 как значение параметра останова.
- При необходимости измените визуализированный текст, выбрав позицию Текст.

i Установка на ноль значения Пуска и Останов меню отключает визуализацию надписи. В случае наложения нескольких зон имеет преимущество та, которая имеет меньший номер.

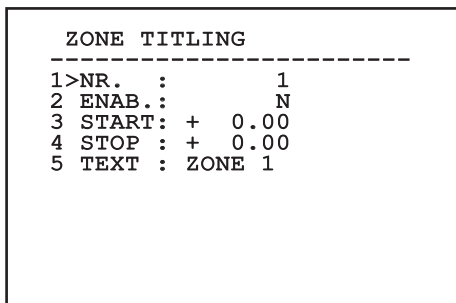
i Определите области движением по часовой стрелке, как показано на рисунке.



Рис. 94

10.1.5.2 Меню Каширования зон

Эта функция позволяет устанавливать до восьми масок (различных размеров) с возможностью титрования.

1. **Число:** Выбирает зону для изменения.
2. **Включение:** Активирует каширование добавленной области.
3. **Start:** Устанавливает начальное положение зоны.
4. **Stop:** Устанавливает конечное положение зоны.
5. **Текст:** Изменяет текст, который отображается, когда зона активирована.

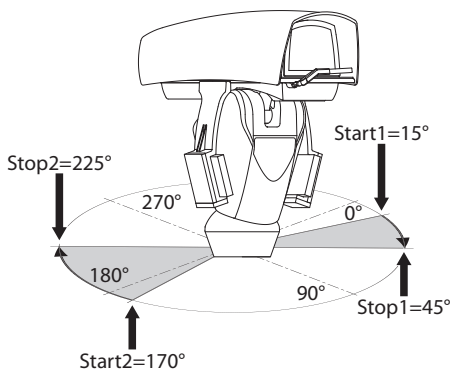
ZONE MASKING			

1	>NR	:	1
2	ENAB.	:	N
3	START	:	+ 0.00
4	STOP	:	+ 0.00
5	TEXT	:	MASK 1

Рис. 95

Пример: Для активации каширования зоны 1, когда устройство находится в диапазоне температур +15° и +45°, необходимо:

- Выберите 1 как значение параметра Nr.
- Активировать каширование зоны, устанавливая S в качестве значения позиции Включение
- Установите +015.00 как значение параметра пуска.
- Установите +045.00 как значение параметра останова.
- При необходимости измените визуализированный текст, выбрав позицию Текст.



Установка на ноль значения Пуска и Остановка меню отключает каширование. В случае наложения нескольких масок имеет преимущество та, которая имеет меньший номер.



Определите шаблоны движением по часовой стрелке, как показано на рисунке.



Рис. 96

10.1.6 Меню Последовательное Футляра

i Сразу же после выхода из OSM камеры нажмите клавишу Iris Close, чтобы вернуться в OSM поворотного устройства.

i Для предотвращения наложения OSM камеры с OSM поворотного устройства необходимо выйти из режима конфигурации камеры перед нажатием клавиши Iris Close.

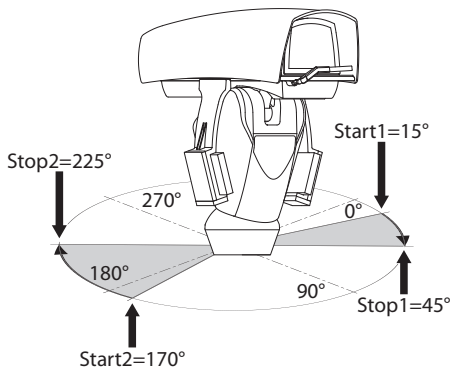
1. **Протокол:** Позволяет выбрать протокол, используемый последовательным портом кожуха.
2. **Baud Rate:** Позволяет выбрать скорость двоичной передачи, используемой последовательным портом кожуха.
3. **Команда "Отправить":** Заменяет команду подтверждения, отправленную с джойстика, на другую персонализированную.
4. **Команда "Выйти":** Заменяет команду выхода, отправленную с джойстика, на другую персонализированную.
5. **Активирует OSM камеры:** Позволяет войти в подменю для конфигурации телекамеры.

```

HOUSING SERIAL PORT
-----
1>PROTOCOL      :      NONE
2 BAUDRATE      :      9600
3 RETURN CMD:   IRIS CLOSE
4 EXIT CMD      :   IRIS OPEN
5 ENABLE CAMERA OSM  >
    
```

Рис. 97

10.1.7 Меню Полярности

Позволяет настроить следующие параметры:

1. **Увеличение:** Позволяет задать полярность вращения двигателя Zoom объектива.
2. **Focus:** Позволяет выбрать полярность вращения двигателя Focus объектива.
3. **Диафрагма:** Позволяет выбрать полярность вращения двигателя Iris объектива.

```

POLARITY
-----
1>ZOOM :      POSITIVE
2 FOCUS :     POSITIVE
3 IRIS  :     POSITIVE
    
```

Рис. 98

10.1.8 Меню движения

1. **Offset Pan:** Наводка имеет положение на 0°, определённое механически. Функция Offset Pan позволяет определить путём программного обеспечения положение, отличающееся от 0°.
2. **Ручной Контроль:** Получив доступ к подменю, которые управляют параметрами, связанными с ручными движениями устройства.
3. **Предварительные настройки:** Позволяет получать доступ к подменю, позволяющим изменять величины Preset.
4. **Патрулирование:** Позволяет получать доступ к подменю, позволяющим изменять величины Patrol.
5. **Автоматическое панорамное наблюдение:** Позволяет получать доступ к подменю, позволяющим изменять величины Autoran.
6. **Вызов Движений:** Позволяет получать доступ к подменю, управляющему автоматическим вызовом движений.

```

MOTION
-----
1>OFFSET PAN:      + 20.00
2 MANUAL CONTROL  >
3 PRESET          >
4 PATROL         >
5 AUTOPAN        >
6 MOTIONS RECALL  >
    
```

Рис. 99

10.1.8.1 Меню ручного контроля

1. **Максимальная Скорость:** Выбор максимальной ручной скорости.
2. **Скорость С Зумом:** Этот параметр, если он включён, автоматически снижает скорость Pan и Tilt в зависимости от коэффициента фокусного расстояния.
3. **Фактор Tilt:** Выбор фактора снижения ручной скорости оси tilt.
4. **Ограничения Движения:** Доступ к меню ограничений.

```

MANUAL CONTROL
-----
1>MAXIMUM SPEED : 20.00
2 VEL. WITH ZOOM : N
3 TILT FACTOR   : 2
4 MOVEMENT LIMITS >
    
```

Рис. 100

10.1.8.2 Меню ручного контроля (Рамки)

Позволяет настроить следующие параметры:

1. **Ограничения Pan:** Подготавливает ограничения Pan.
2. **Начало Pan:** Устанавливает начальное ограничение Pan.
3. **Окончание Pan:** Устанавливает конечное ограничение Pan.
4. **Начало Tilt:** Устанавливает начальное ограничение Tilt.
5. **Окончание Tilt:** Устанавливает конечное ограничение Tilt.

```

LIMITS
-----
1>PAN LIMITS      :      N
2 PAN START      : +  0.00
3 PAN END        : +  0.00
4 TILT START     : +  0.00
5 TILT END       : +  0.00
    
```

Рис. 101

Меню выполняет динамическую автоконфигурацию в соответствии с выбором при показе параметров, которые можно изменять.

10.1.8.3 Меню Preset

1. **Изменяет Preset:** Для доступа к меню Изменения Preset.
2. **Службная Программа Preset:** Для доступа к меню Функции Preset.

```

PRESET
-----
1>EDIT PRESET      >
2 PRESET UTILITIES >
    
```

Рис. 102

10.1.8.4 Меню Preset (Изменяет Preset)

Позволяет настроить следующие параметры:

1. **Число:** Номер Preset, который желаете изменить.
2. **Включение:** Включение preset.
3. **Pan:** Положение pan, выраженное в градусах.
4. **Tilt:** Положение tilt, выраженное в градусах.
5. **Скорость:** Скорость достижения положения, когда preset вызывается функцией Patrol и функцией автопанорамирования.
6. **Пауза:** Ожидание в секундах перед началом следующего движения в патрулировании (Patrol).
7. **Текст:** Надпись отображается при достижении положения preset.
8. **Перейти к Preset?:** Заставляет поворотное устройство достигнуть положения, заданного предварительными настройками (Preset).
9. **Активирует движения:** Позволяет выбрать новый кадр.

```

EDIT PRESET
-----
1>NR.      :      1
2 ENAB.    :      N
3 PAN      : +  0.00
4 TILT     : - 40.00
5 SPEED    :  20.00
6 PAUSE    :      5
7 TEXT     : PRESET 001
8 GO TO PRESET?
9 ENABLE MOVEMENTS      >
    
```

Рис. 103

С меню можно сохранить непосредственно preset, отправив команду Iris Close, включающую движения наводки.

10.1.8.5 Меню Preset (Служебная Программа Preset)

Позволяет настроить следующие параметры:

1. **Скорость Сканирования:** Скорость, используемая для достижения положения Preset после получения команды Scan.
2. **Скорость По Умолчанию:** Скорость по умолчанию Preset. Эта величина используется функцией Установить скорость? для присвоения всем Preset той же скорости.
3. **Пауза По Умолчанию:** Пауза по умолчанию Preset. Это значение используется функцией Установить паузу? для присвоения всем Preset той же паузы.
4. **Значение рампы ::** Время начала и остановки. Большему числу соответствует большее ускорение / замедление в фазу пуска/останова.
5. **Установить скорость?:** Назначает всем Preset скорость по умолчанию.
6. **Установить паузу?:** Назначает всем Preset паузу по умолчанию.

```

PRESET UTILITIES
-----
1>SCAN SPEED      : 20.00
2 DEFAULT SPEED   : 10.00
3 DEFAULT DWELL   : 3
4 RAMP VALUE      : 12
5 SET SPEED?
6 SET DWELL TIME?
    
```

Рис. 104

10.1.8.6 Меню патрулирования (Patrol)

1. **Первый Preset:** Первый preset последовательности Patrol.
2. **Последний Preset:** Последний preset последовательности Patrol.
3. **Режим Random:** Подготавливает выполнение случайным образом. Последовательность пересчитывается непрерывно.

```

PATROL
-----
1>FIRST PRESET    : 1
2 LAST PRESET     : 250
3 RANDOM MODE     : N
    
```

Рис. 105

10.1.8.7 Меню Autoran (автопанорамирование)

1. **Preset Хода:** Начальное положение автопанорамирования.
2. **Preset Возврата:** Конечное положение автопанорамирования.

```

AUTO-PAN
-----
1>PRESET OUTWARD : 1
2 PRESET RETURN  : 2
    
```

Рис. 106

i Скорость достижения положений Preset определена в соответствующей главе (10.1.8.4 Меню Preset (Изменяет Preset), страница 47).

10.1.8.8 Меню вызова движений

Можно настроить узел таким образом, что после определенного периода простоя автоматически выполняется функция движения, установленная оператором.

1. **Вид Движения:** Типа движения для вызова (None, Home, Автоматическое панорамное наблюдение, Патрулирование).
2. **Задержка Движения:** Время простоя джойстика, указывается в секундах.



Рис. 107

10.1.9 Меню визуализаций

1. **Текущее положение:** Если не стоит на OFF, позволяет выбрать режим, при котором будут выведены на экране значения Pan, Tilt, Zoom, Focus и Iris.
2. **Имя Preset:** Если не стоит на OFF, позволяет выбрать режим, при котором будет выводиться на экран текст, присвоенный последнему достигнутому положению Preset. Можно выбрать визуализацию по времени (1 s, 3 s и 5 s) или постоянную (Const).
3. **ID Наводки:** Если место отличается от OFF, визуализирует ID продукт.
4. **Сигналы тревоги:** Если не стоит на OFF, позволяет выбрать режим, при котором будут отображаться тексты, присвоенные аварийному сигналу. Можно выбрать визуализацию по времени (1 s, 3 s и 5 s) или постоянную (Const).

5. **Полученные Команды:** Позволяет активировать визуализацию полученных последовательных команд.
6. **Горизонтальная Delta:** Горизонтальное смещение текстов меню для наилучшей центровки.
7. **Вертикальная Delta:** Вертикальное смещение текстов меню для наилучшей центровки.
8. **Видосигнал:** Формат видео-сигнала.

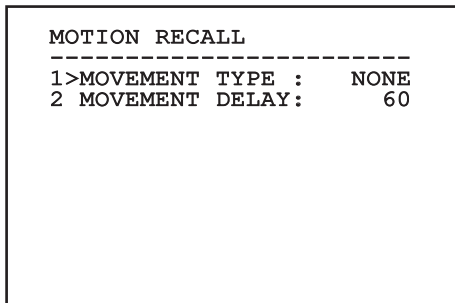

Рис. 108

Меню конфигурируется автоматически и динамически в зависимости от модели поворотного устройства.

10.1.10 Меню Цифровых I/O-Опции

1. **Сигналы тревоги:** Доступ к меню аварийных сигналов.
2. **Установка Мойки:** Доступ к меню установки мойки.
3. **Связь:** Доступ к меню Коммуникации.

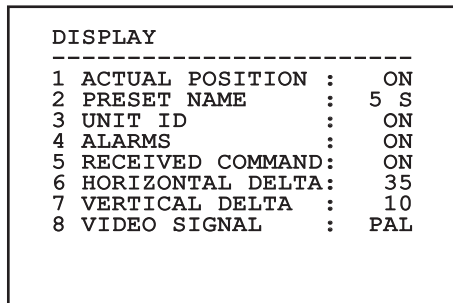

Рис. 109

10.1.10.1 Меню тревог

- 01-04. **Сигналы тревоги 1-4:** Доступ к меню, в которых можно изменять параметры аварийных сигналов от 1 до 4.
05. **Состояние тревог:** Доступ к меню статуса аварийных сигналов.

```

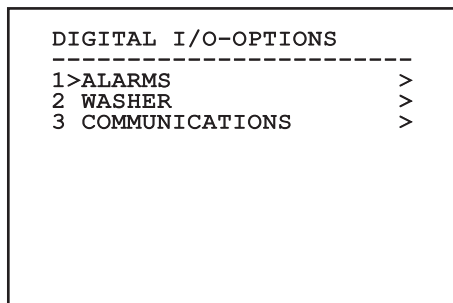
ALARM
-----
1>ALARM 1          >
2  ALARM 2          >
3  ALARM 3          >
4  ALARM 4          >
5  ALARMS STATE    >
  
```

Рис. 110

Меню конфигурируется автоматически и динамически в зависимости от модели поворотного устройства.

В меню отдельных аварийных сигналов можно настроить следующие значения:

- Вид:** Тип контакта, обычно закрытый (N.C.) или обычно открытый (N.O.)
- Действие:** Тип действия, который выполняет узел, когда активируется сигнал тревоги (Off, Msg, PTZ Stop, Wiper, Washer, Scan, Патрулирование, Автоматическое панорамное наблюдение, Relay, Ir Filt). Параметр OFF отключает аварийный сигнал.
- Число:** Достижимый preset, когда типом действия тревоги является Scan.
- Текст:** Сообщение выходит при активном аварийном сигнале.

```

ALARM 1
-----
1>TYPE :      N.C.
2  ACT. :      SCAN
3  NR.  :      1
4  TEXT :  ALARM 1
  
```

Рис. 111

Меню выполняет динамическую автоконфигурацию в соответствии с выбором при показе параметров, которые можно изменять.

В меню статуса аварийных сигналов выводится состояние входа аварийных сигналов (Closed, Open).

```

ALARMS STATE
-----
ALARM 1          CLOSED
ALARM 2          OPEN
ALLARME 3        CLOSED
ALLARME 4        CLOSED
  
```

Рис. 112

10.1.10.2 Меню связи

- Серийное подтверждение (ACK):** Настройка поворотной опоры, для включения/отключения отправки ответа с подтверждением серийным устройствам управления.
- ACK PELCO D Standard:** Настроить ответное подтверждение устройства управления PELCO D. Меню скрыто, если с помощью переключателя DIP установлен протокол связи, отличающийся от PELCO D, или если ответное подтверждение не включено (ACK SERIALE = FALSE). Если пункт меню доступен, ответное подтверждение является стандартным (для расчета контрольной суммы используется исходное сообщение). Если пункт меню недоступен, для расчета контрольной суммы используется только сам пакет подтверждения.

```

COMMUNICATIONS
-----
1 SERIAL ACK      : Y
2 DEFAULT PELCOD ACK : N
  
```

Рис. 113

10.1.10.3 Меню моющей установки

Узел предлагает возможность использовать стеклоочиститель и приводить в действие насос для очистки стекла.

Для конфигурации установки мойки установите объектив телекамеры перед соплом установки мойки.

Сохраните preset (XY) для этого положения, которая будет вызываться от насадки, когда включается функция Washer.

Конфигурировать следующие параметры:

1. **Включает:** Подключение функции Washer.
2. **Nozzle Preset:** Введите номер preset (XY), соответствующий соплу.
3. **Wiper On Delay:** Выберите интервал времени, который проходит от активации насоса и от активации стеклоочистителя.
4. **Длительность мойки:** Выберите продолжительность очистки щетками.
5. **Wiper Off Delay:** Выберите продолжительность очистки щетками без воды.

```

WASHER
-----
1>ENABLE           : N
2 NOZZLE PRESET    : 1
3 WIPER-ON DELAY  : 5
4 WASHING DURATION : 10
5 WIPER-OFF DELAY : 5
    
```

Рис. 114

10.1.11 Меню по умолчанию

1. **Аннулировать Setup?:** Восстанавливает все параметры за исключением preset.
2. **Аннулировать Preset?:** Удалить все ранее сохраненные preset.

```

DEFAULT
-----
1>DELETE SETUP?
2 DELETE PRESET?
    
```

Рис. 115



Описанные выше операции ведут к утере всех предварительно сохранённых данных (например: Preset, Patrol, Autopan, Home...).

10.1.12 Меню информации

Меню позволяет проверять конфигурацию устройства и версию аппаратно-программного обеспечения.

```

INFO
-----
Device ID: 00001
Type      : Rs485 only Rx
Baud Rate: 38400-8N1
Protocol  : MACRO
Net Board: Fw6.02 Hw01
Mpp Board: Fw6.02 Hw00
Config.   : 001
P.C.      : UPT1SVSA000E
S.N.      : 000000000000
Upgrade   : NET BOARD
    
```

Рис. 116

11 Комплектующие

i Для дополнительной информации по конфигурации и использованию обращаться к руководству по эксплуатации соответствующего оборудования.

11.1 Установка мойки

Поворотное устройство может быть укомплектовано внешним насосом для очистки стекла.



Рис. 117

11.1.1 Подключение мощного оборудования

! ПРЕДУПРЕЖДЕНИЕ! Установка типа TNV-1. Не подключайте к системам SELV.

! ПРЕДУПРЕЖДЕНИЕ! Для снижения опасности пожара пользуйтесь исключительно кабелями, имеющими сертификат UL Listed или CSA, имеющими разъемы не менее $0,14\text{mm}^2$ (26AWG).

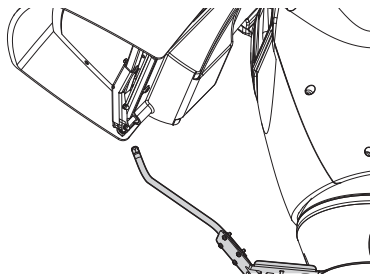
! Все сигнальные кабели должны быть сгруппированы под одним хомутиком.

ПОДКЛЮЧЕНИЕ МОЩНОГО ОБОРУДОВАНИЯ	
Клеммы	Описание
AL1-COM AL1-AGND	Вход сигнала тревоги. Установки мойки оснащены датчиком уровня, который сигнализирует об отсутствии жидкости в баке.
O1-C1	Чистый контакт для включения установки мойки.

Таб. 17



Рис. 118 Стандартную версию.



Рис. 119 Версия со LED осветителями.

i За дополнительной информацией обратитесь к соответствующей главе (10.1.10.3 Меню мощней установки, страница 51).

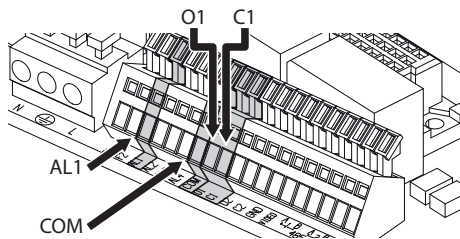
11.2 Настенное крепление

Настенный кронштейн с внутренним кабельным каналом.

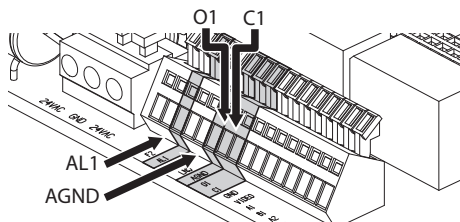

Рис. 120

11.3 Кронштейн для крепления параллельно потолку

Кронштейн для крепления параллельно потолку с внутренним кабельным каналом.

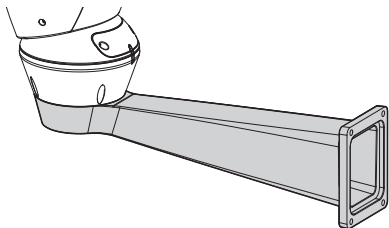

Рис. 121

11.4 Блок питания с функцией контроля осветителей

Герметичная коробка с блоком питания и контроля осветителей.

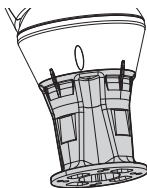

Рис. 122 Версия стандартной коробки.



Рис. 123 Сертифицированный вариант корпуса UL.

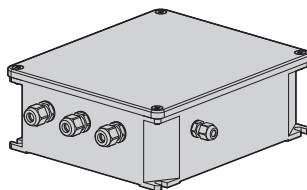

За дополнительной информацией обратитесь к соответствующей главе (8.5.3 Подключение входов сигналов тревоги, сумеречного выключателя и реле, страница 26).

12 Инструкции по обычному функционированию

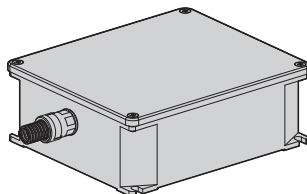
12.1 Отображение состояния наводки

Во время нормальной работы по выбору пользователя наводка отображает на мониторе данные, организованные, как показано на рисунке. Отображение может быть включено или выключено (10.1.9 Меню визуализаций, страница 49).

ID 1: Адрес приёмника;

ZONE 1: Имя зоны, в которой находитесь;

MASK 1: Название выведенного шаблона;

ALARM 1: Текст последней тревоги активен;

Preset 001 go to Команды, полученные с помощью последовательной линии;

E1: PATROL CONFIGURATION: Вывод ошибок, обнаруженных во время работы системы;

PAN/TILT/Z/F/I: Актуальное положение PAN, TILT, ZOOM, FOCUS и IRIS;

PRESET 001: Имя выбранного preset активно.

```
ID 1
ZONE 1
MASK 1
ALARM1
Preset 001 go to

E1: PATROL CONFIGURATION
PAN : +000.00
TILT: +000.00
Z:000.0 F:000.0 I:000.0
PRESET 001
```

Рис. 124

12.2 Сохранение Preset

Посредством используемого устройства контроля можно сохранить текущее положение (за дополнительной информацией обращайтесь к руководству по эксплуатации используемого устройства).

12.3 Вызов положения Preset (Scan)

Посредством устройства управления можно вызвать какое-либо положение Preset, сохраненное ранее (за дополнительной информацией обращайтесь к руководству по эксплуатации используемого устройства).

12.4 Вызов положения Home

Посредством клавиатуры управления можно вызвать положение Home (Scan n.1), сохраненное ранее (за дополнительной информацией обращайтесь к руководству по эксплуатации используемого устройства контроля).

12.5 Включение Patrol

Функция Patrol последовательно вызывает сохраненные предварительные настройки (preset).

По вопросам подключения/отключения функции контроля или к соответствующей главе (12.11 Специальные команды, страница 56).

Для отключения функции переместите джойстик или вызовите другой тип движения.

По вопросам конфигурации данной функции обратитесь к соответствующей главе (10.1.8.6 Меню патрулирования (Patrol), страница 48).

12.6 Включение автопанорамирования

Функция Autoran постоянно вызывает 2 сохраненные предварительные настройки (preset).

По вопросам подключения/отключения функции обращайтесь к руководству по эксплуатации устройства контроля или к соответствующей главе (12.11 Специальные команды, страница 56).

Для отключения функции переместите джойстик или вызовите другой тип движения.

По вопросам конфигурации данной функции обратитесь к соответствующей главе (10.1.8.7 Меню Autoran (автопанорамирование), страница 48).

12.7 Активация стеклоочистителя (Wiper)



Не пользуйтесь стеклоочистителем, когда внешняя температура ниже 0°C или имеется лёд.

По вопросам подключения/отключения функции обращайтесь к руководству по эксплуатации устройства контроля или к соответствующей главе (12.11 Специальные команды, страница 56).



Стеклоочиститель деактивируется автоматически, если остаётся включённым.

12.8 Активирует систему мойки (Washer)

Когда отправляется команда, поворотное устройство располагается окном перед форсункой. Активируются насос и стеклоочиститель на определенный период времени. В конце процедуры поворотное устройство вернется в начальное положение.

По вопросам подключения/отключения функции обращайтесь к руководству по эксплуатации устройства контроля или к соответствующей главе (12.11 Специальные команды, страница 56).

По вопросам подключения специальных настроек обратитесь к соответствующей главе (12.12 Специальные конфигурации, страница 57).

Модели с моющей установкой, оснащенной датчиком уровня, генерируют соответствующее сообщение, когда жидкости в баке недостаточно.

12.9 Активация светодиодного (LED) осветителя

Если установка не оснащена сумеречным выключателем, можно активировать/деактивировать светодиодный осветитель посредством специальной команды. (12.11 Специальные команды, страница 56).

12.10 Перезагрузка узла

Посредством клавиатуры управления можно отправить команду перезапуска узла (за дополнительной информацией обращайтесь к руководству по эксплуатации используемого устройства контроля).

За дополнительной информацией обратитесь к соответствующей главе (12.11 Специальные команды, страница 56).

12.11 Специальные команды

СПЕЦИАЛЬНЫЕ КОМАНДЫ						
Действие	Команда					
	Протокол					
	AMERICAN DYNAMICS	ERNITEC	PANASONIC	PELCO D	VIDEOTEC MACRO	VISTA
Wiper Start	Сохранить Preset 85	Сохранить Preset 85	Сохранить Preset 85	Сохранить Preset 85	Сохранить Preset 85	Сохранить Preset 85
	Aux 3 ON	Aux 3 ON	Сохранить Preset 54	Aux 3 ON	Aux 3 ON	Aux 3 ON
					Wip+	
Wiper Stop	Сохранить Preset 86	Сохранить Preset 86	Сохранить Preset 86	Сохранить Preset 86	Сохранить Preset 86	Сохранить Preset 86
	Aux 3 OFF	Aux 3 OFF	Сохранить Preset 55	Aux 3 OFF	Aux 3 OFF	Aux 3 OFF
					Wip-	
Washer Start	Сохранить Preset 87	Сохранить Preset 87	Сохранить Preset 87	Сохранить Preset 87	Сохранить Preset 87	Сохранить Preset 87
	Aux 4 ON	Aux 4 ON	Сохранить Preset 56	Aux 4 ON	Aux 4 ON	Aux 4 ON
					Was+	
Ночной Режим Вкл	Сохранить Preset 88	Сохранить Preset 88	Сохранить Preset 88	Сохранить Preset 88	Сохранить Preset 88	Сохранить Preset 88
			Сохранить Preset 57			
Ночной Режим Выкл	Сохранить Preset 89	Сохранить Preset 89	Сохранить Preset 89	Сохранить Preset 89	Сохранить Preset 89	Сохранить Preset 89
			Сохранить Preset 58			
Patrol Stop	Сохранить Preset 92	Сохранить Preset 92	Сохранить Preset 92	Сохранить Preset 92	Сохранить Preset 92	Сохранить Preset 92
	Joystick	Joystick	Joystick	Joystick	Joystick	Joystick
			Сохранить Preset 59		Pat-	
Patrol Start	Сохранить Preset 93	Сохранить Preset 93	Сохранить Preset 93	Сохранить Preset 93	Сохранить Preset 93	Сохранить Preset 93
	Активирует pattern 1	Активирует patrol (патрулирование)	Сохранить Preset 60	Pattern	Pat+	Активирует patrol (патрулирование)
Перезагрузка устройства	Сохранить Preset 94	Сохранить Preset 94	Сохранить Preset 94	Сохранить Preset 94	Сохранить Preset 94	Сохранить Preset 94
	Faster+ Zoom out+ Focus far+ Iris open		Сохранить Preset 61		Ini+	
Активация OSM	Сохранить Preset 95	Сохранить Preset 95	Сохранить Preset 95	Сохранить Preset 95	Сохранить Preset 95	Сохранить Preset 95
	Iris open+ Focus+ Zoom out		Сохранить Preset 46		Men+	
Autopan Stop	Сохранить Preset 96	Сохранить Preset 96	Сохранить Preset 96	Сохранить Preset 96	Сохранить Preset 96	Сохранить Preset 96
	Joystick	Joystick	Joystick	Joystick	Joystick	Joystick
			Сохранить Preset 62		Apa-	
Autopan Start	Сохранить Preset 99	Сохранить Preset 99	Сохранить Preset 99	Сохранить Preset 99	Сохранить Preset 99	Сохранить Preset 99
	Активирует pattern 2	Активирует Autopan	Сохранить Preset 63	Pattern 1	Apa+	Активирует Autopan

Таб. 18

12.12 Специальные конфигурации

СПЕЦИАЛЬНЫЕ КОНФИГУРАЦИИ					
Конфигурация	Протокол				
	AMERICAN DYNAMICS	PANASONIC	PELCO D	VIDEOTEC MACRO	VISTA
Washer Конфигурация 1 (краткий цикл мытья)	Сохранить Preset 72	Сохранить Preset 72	Сохранить Preset 72	Сохранить Preset 72	Сохранить Preset 72
Washer Конфигурация 2 (длинный цикл мытья)	Сохранить Preset 73	Сохранить Preset 73	Сохранить Preset 73	Сохранить Preset 73	Сохранить Preset 73

Таб. 19

13 Техобслуживание



Техобслуживание должен выполнить только персонал с квалификацией работы на электрических контурах.

13.1 Замена предохранители



Всегда выполнять техобслуживание при отсутствии питания и с открытым разъединяющим устройством.

В случае необходимости заменить предохранители показано на рисунке (8.3 Описание платы разъемов, страница 21).

ЗАМЕНА ПРЕДОХРАНИТЕЛИ		
Напряжение	Плавкий предохранитель F1	Плавкий предохранитель F2
24Vac, 50/60 Гц	T 4A L 250V 5x20	T 6.3A H 250V 5x20 (стандартная модель)
		T 8A H 250V 5x20 (модель со светодиодными осветителями)
120Vac, 50/60 Гц	T 4A L 250V 5x20	T 4A H 250V 5x20
230Vac, 50/60 Гц	T 4A L 250V 5x20	T 2A H 250V 5x20

Таб. 20

14 Уборка

14.1 Очистка стекла и пластмассовых частей



Избегать применение этилового спирта, растворителей, гидрированных углеводородов, сильных кислот и щелочей. Использование названных продуктов наносит непоправимый вред обрабатываемой поверхности.

Для очистки линз очков рекомендуется пользоваться мягкой тканью с раствором нейтрального мыла или специальных чистящих средств в воде.

14.2 Очистка стеклянного окошка с содержанием германия.



Чистить окно, обращая внимание на то, чтобы не поцарапать внешнюю поверхность, обработанную графитовым покрытием. При повреждении этой поверхности, существует риск негативно повлиять на инфракрасную прозрачность поверхности.

Очистка должна быть выполнена нейтральным моющим средством, разбавленным водой.

15 Вывоз в отходы



Этот символ и система утилизации имеют значение только в странах ЕС и не находят применения в других странах мира.

Ваше изделие было изготовлено из материалов и компонентов высокого качества, могущих быть повторно использованными или утилизированными.

Электрические и электронные материалы, на которых имеется указанный символ, в конце срока службы должны выбрасываться отдельно от бытовых отходов.

Просим вывезти это устройство в Центр сбора или на экологическую станцию.

В Европейском Сообществе существуют системы дифференцированного сбора мусора для электронных и электрических изделий.

16 Устранение неисправностей

Запросить операцию квалифицированного персонала, поскольку:

- Узел повреждён вследствие падения;
- Эксплуатационные характеристики узла получили явное ухудшение;
- Устройство не работает должным образом, даже если вы выполнили все указания, приведенные в настоящем руководстве.

ПРОБЛЕМА	Устройство не включается.
ПРИЧИНА	Ошибочная кабельная проводка, поломка плавких предохранителей.
РЕШЕНИЕ	Проверьте правильность выполнения соединений. Проверьте сохранность плавких предохранителей и, в случае неполадки, замените на указанные.

ПРОБЛЕМА	В особых условиях увеличения существуют помехи от чехла или навеса полученному изображению (только для версий с моторизованным объективом).
ПРИЧИНА	Видеокамера или объектив слишком отошли назад по отношению к окну.
РЕШЕНИЕ	Отрегулировать положение видеокамеры и объектива.

ПРОБЛЕМА	На мониторе не отображается снятое изображение, а синий экран с сообщением: Нет видеосигнала!
ПРИЧИНА	Неправильная электропроводка или неисправность видеокамеры.
РЕШЕНИЕ	Проверьте правильность выполнения соединений.

ПРОБЛЕМА	Во время включения поворотная опора остается в заблокированном состоянии и отображается следующий стандартный экран:
-----------------	---

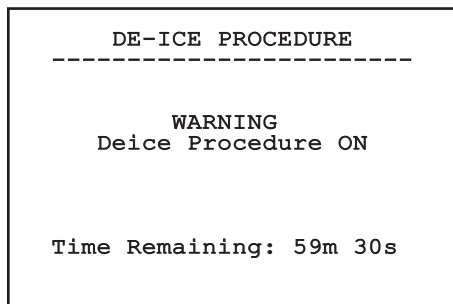

ПРИЧИНА	Температура окружающей среды очень низкая.
РЕШЕНИЕ	Подождите окончания процедуры предварительного нагрева. Если температура окружающей среды слишком низкая, устройство будет заблокировано, отображая следующее экранное изображение:

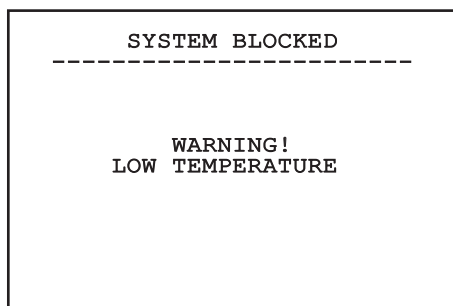

ПРОБЛЕМА На мониторе не отображается снятое изображение, а следующее окно:

```

-----
                INFO
-----
Device ID: 00001
Type      : Rs485 only Rx
Baud Rate: 19200-8N1
Protocol  : PELCO-D
Net Board: Fw05.01 Hw00
Mpp Board: Fw05.01 Hw00
Config.   : 001
P.C.      : UPT1SMSA005C
S.N.      : 0000000000000
Upgrade   : NET BOARD
    
```

ПРИЧИНА Dip-переключатель программирования активирован

РЕШЕНИЕ Выключите поворотное устройство. Опустите язычок dip-переключателя обновления программно-аппаратного обеспечения (8.14.2 Конфигурация DIP1, страница 34). Снова включите блок.

ПРОБЛЕМА **Ошибка E1: PATROL CONFIGURATION**

ПРИЧИНА Preset не были сохранены.

Preset не были подключены.

РЕШЕНИЕ Сохранить два или более preset (12.2 Сохранение Preset, страница 54). Обновите меню конфигурации Patrol (10.1.8.6 Меню патрулирования (Patrol), страница 48). Подключите начальные установки (10.1.8.4 Меню Preset (Изменяет Preset), страница 47).

ПРОБЛЕМА **Ошибка E2: AUTOPAN CONFIGURATION.**

ПРИЧИНА Два preset, использованные как ограничения, не были сохранены. Два preset, использованные как ограничения, не были подключены.

РЕШЕНИЕ Сохранить два preset (12.2 Сохранение Preset, страница 54). Обновите меню конфигурации автопанорамирования (10.1.8.7 Меню Autoran (автопанорамирование), страница 48). Подключите начальные установки (10.1.8.4 Меню Preset (Изменяет Preset), страница 47).

ПРОБЛЕМА **Ошибка E3: WASHER DISABLED либо ошибка E4:WASHER PRST DISABLED.**

ПРИЧИНА Установка мойки не подключена.

РЕШЕНИЕ Активировать моющую установку (10.1.10.3 Меню моющей установки, страница 51).

ПРОБЛЕМА **Ошибка PRESET XXX NOT ENABLED.**

ПРИЧИНА Вызов несохраненного preset.

Вызов неподключенного preset.

РЕШЕНИЕ Сохранить preset со специальной командой (12.2 Сохранение Preset, страница 54). Подключите начальную установку (10.1.8.4 Меню Preset (Изменяет Preset), страница 47).

17 Технические параметры

17.1 Общие характеристики

Изготавливается из алюминия и технополимера
Эпоксиполиэстеровое порошковое покрытие, цвет RAL9002
Верхнее крепление (ОТТ)
Электронные ограничители хода
Нулевой зазор
Максимальный вес камеры с объективом: 7.6 кг
Оптические датчики для точного позиционирования
Максимальное количество предварительных установок: 250 (VIDEOTEC MACRO)
15-символьная строка для обозначения зон и предварительных настроек
Конфигурация посредством экранного меню
Адресация до 255 устройств посредством DIP-переключателя

17.2 Технические характеристики

Кабельные муфты: 3xM16
Вращение по горизонтали: продолж.
Вертикальное перемещение: от +45° до -20°
Скорость горизонтального поворота (регулируется): от 0,02°/с до 20°/с
Скорость вертикального вращения (регулируется): от 0,02°/с до 20°/с
Пространство внутри корпуса: См. чертежи
Передача усилия через зубчатый ремень
Точность предварительно установленных положений: 0.02°
Вес устройства: 30 кг

17.3 Окно кожуха

Стеклопанельное окно
• Размеры: 112 ммx95 мм
Германиевое стекло
• Диаметр: 85 мм (наруж.), 70 мм (рабочий диаметр)
• Толщина: 2 мм
• Обработка внешней поверхности стекла для защиты от царапин: Высокопрочное углеродное покрытие (DLC)
• Антибликовое покрытие на внутренней стороне стекла
Спектральный диапазон: от 7.5 мкм до 14 мкм
Средний коэффициент пропускания (от 7.5 мкм до 11,5 мкм): 94%
Средний коэффициент пропускания (от 11,5 мкм до 14 мкм): 90%
Проводимость окна из германия



Рис. 125

17.4 Электрические характеристики

Питание/Потребление тока:
• 230Vac, 0,4 А, 50/60 Гц
• 24Vac, 4А (8А со светодиодными осветителями), 50/60 Гц
• 120Vac, 0.8 А, 50/60 Гц
Потребление энергии:
• 100 Вт
• 150-190 Вт макс. со светодиодными осветителями в 24Vac
• 24 Вт, поворотное устройство остановлено, подогрев выключен
Источник питания камеры: 12 В постоянного тока, 800мА
Сечение входных кабелей:
• 0.75мм ² (18AWG), 120Vac или 230Vac
• 1.5мм ² (16AWG), 24Vac
Сечение сигнальных кабелей: от 0.14мм ² (26AWG) до 0.5мм ² (20AWG)

17.5 Видео

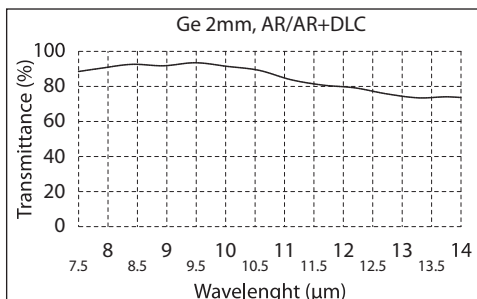
Видео линия: коаксиальный кабель (напряжение пика 1 В, 75 Ом)

17.6 Связь

Интерфейс RS-232 для обновления микропрограмм

2 порта RS-485 для цепная конфигурация

17.7 Протоколы

Конфигурация параметров протоколов телеметрии с помощью DIP-переключателя

Поддерживаемые протоколы:

- AMERICAN DYNAMICS
- PANASONIC
- PELCO D
- VIDEOTEC MACRO
- VISTA

17.8 Интерфейс ввода-вывода

Вход сигнала тревоги:

- 4 (стандартная модель)
- 2 (модель со светодиодными осветителями)
- Управляющее напряжение: От 10 В постоянного тока до 35 В постоянного тока

Сухие контакты:

- 2 (стандартная модель)
- 1 (модель со светодиодными осветителями)
- Применяемое напряжение: 50 В постоянного тока макс. или 30 В переменного тока@1A

17.9 Объективы

Источник питания: От 6 В постоянного тока а 15 В постоянного тока, 200mA макс.

Управление: С инверсией полярности и общим проводом

17.10 Среда

Внутреннее наблюдение/Наружное наблюдение

Рабочая температура (с нагревателем): От -10° (14°F) до +60°C (140°F)

17.11 Сертификаты

Электрическая безопасность (CE (соответствие Директивам Евросоюза)): EN60950-1

Электромагнитная совместимость (CE (соответствие Директивам Евросоюза)): EN50130-4, EN55022 (Класс B), FCC часть 15 (Класс B)

Установка вне помещений (CE (соответствие Директивам Евросоюза)): EN60950-22

Степень защиты IP: EN60529 (IP66)

Защита от солевого тумана: EN50130-5, EN60068-2-52

Сертификат EAC

18 Технические чертежи



Размеры в чертежах выражены в миллиметрах.



Рис. 126 ULISSE MAXI, стандартная модель.



Рис. 127 ULISSE MAXI, версия с приспособлениями для установки светодиодных (LED) осветителей.

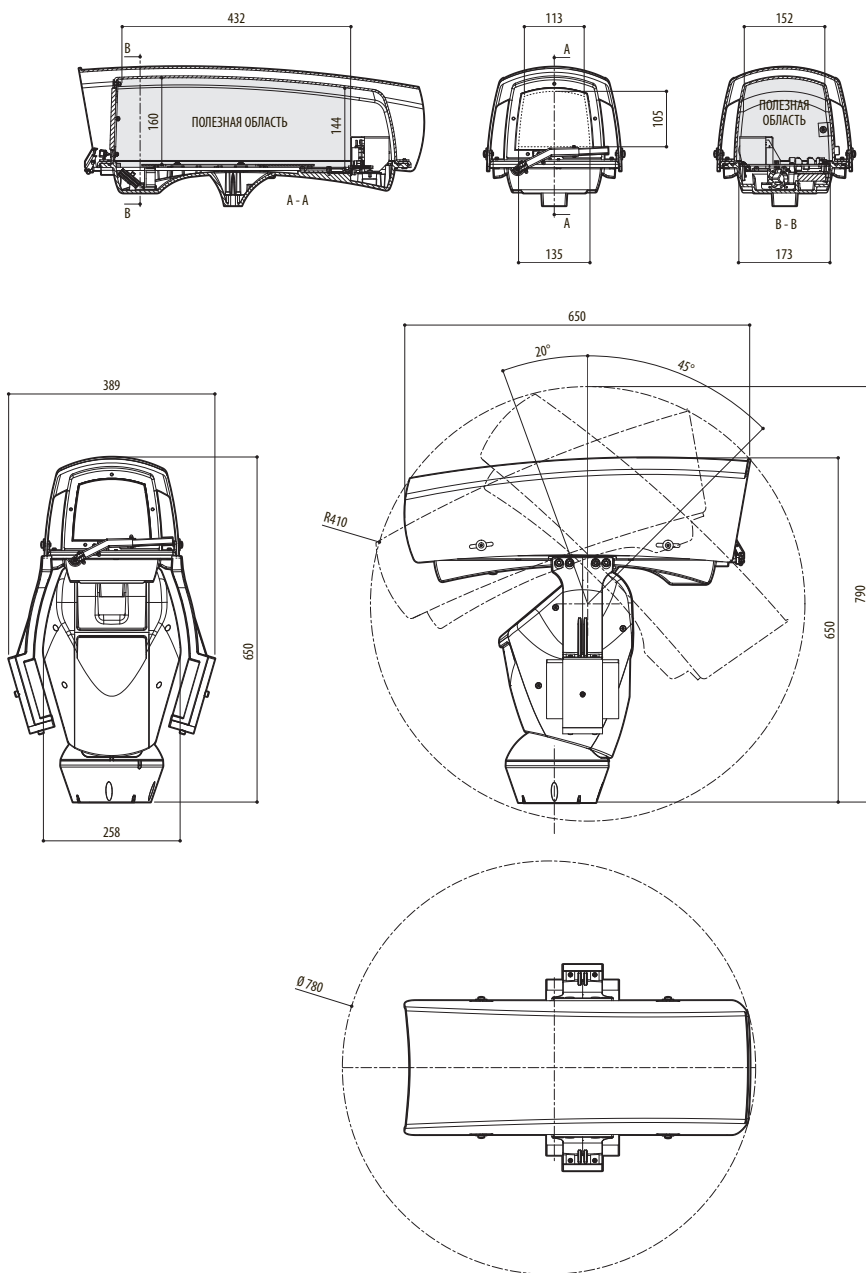

Рис. 128 ULISSE MAXI, версия для тепловых камер.

А Приложение - Таблица адресов

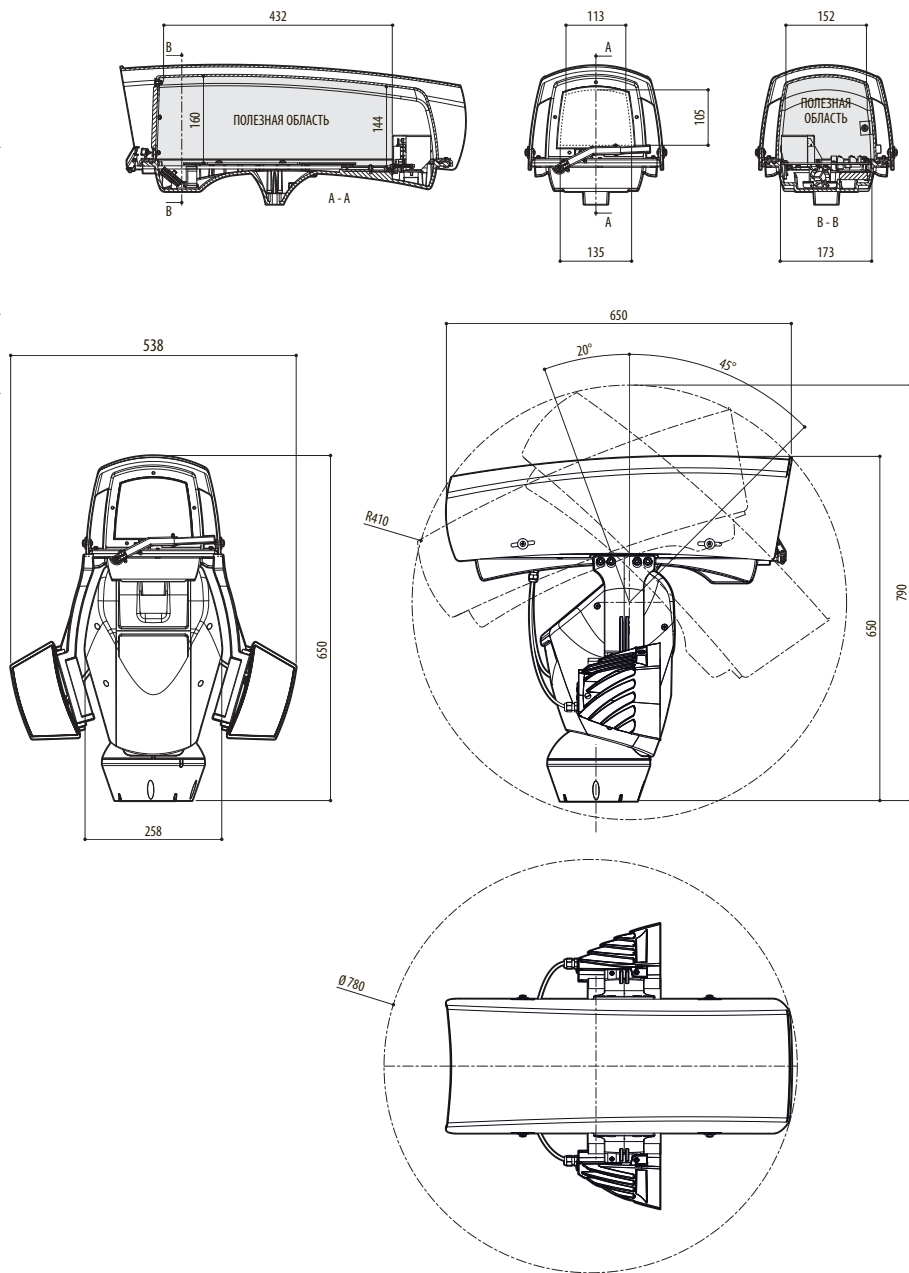

Рычажок переключателя в положении вверх представляет значение 1 (ON), Рычажок вниз - значение 0 (OFF).

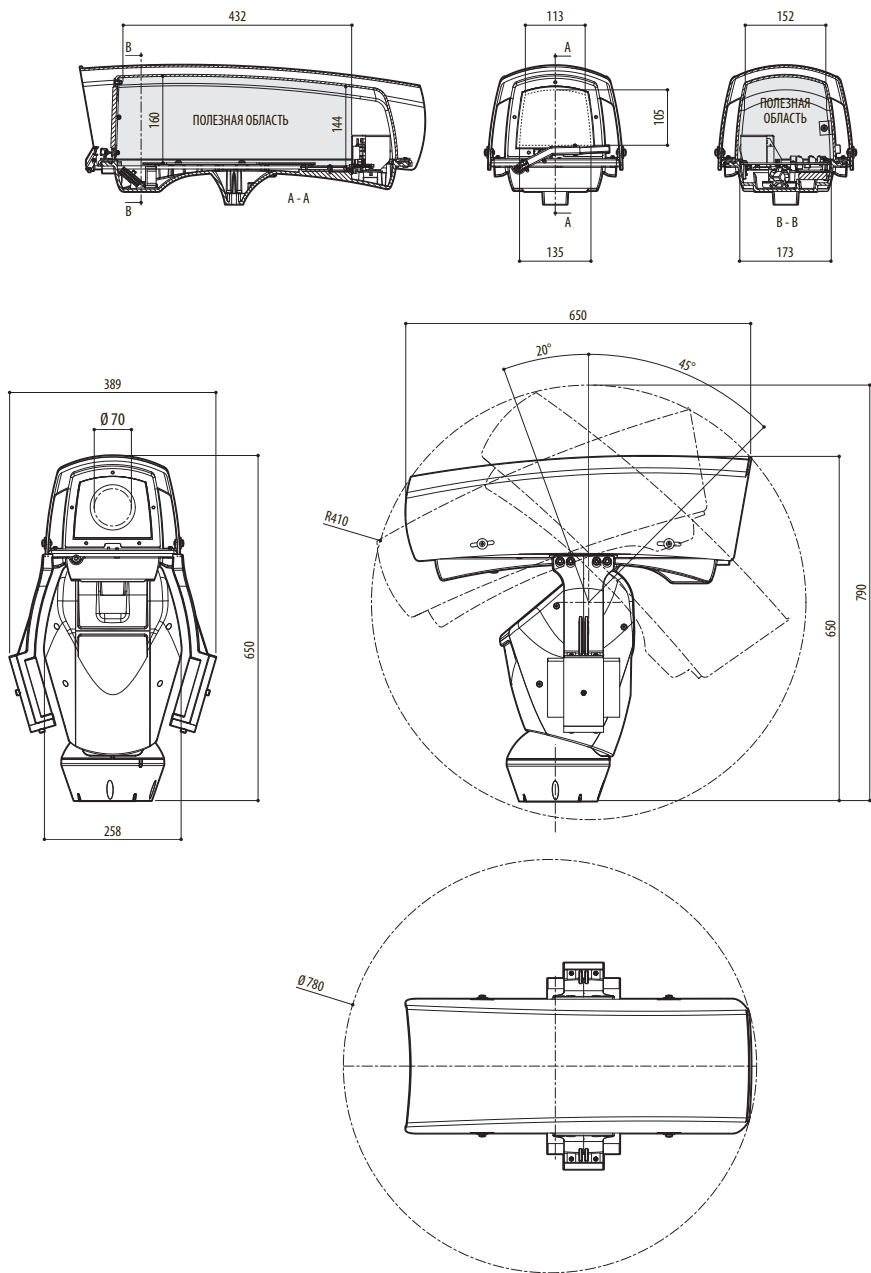
Ниже перечислены все возможные комбинации.

УСТАНОВКА АДРЕСА (DIP 3)

SW 8	SW 7	SW 6	SW 5	SW 4	SW 3	SW 2	SW 1	Адрес
OFF	OFF	OFF	OFF	OFF	OFF	OFF	OFF	Адрес недействительный
OFF	OFF	OFF	OFF	OFF	OFF	OFF	ON	Адрес 1
OFF	OFF	OFF	OFF	OFF	OFF	ON	OFF	Адрес 2
OFF	OFF	OFF	OFF	OFF	OFF	ON	ON	Адрес 3
OFF	OFF	OFF	OFF	OFF	ON	OFF	OFF	Адрес 4
OFF	OFF	OFF	OFF	OFF	ON	OFF	ON	Адрес 5
OFF	OFF	OFF	OFF	OFF	ON	ON	OFF	Адрес 6
OFF	OFF	OFF	OFF	OFF	ON	ON	ON	Адрес 7
OFF	OFF	OFF	OFF	ON	OFF	OFF	OFF	Адрес 8
OFF	OFF	OFF	OFF	ON	OFF	OFF	ON	Адрес 9
OFF	OFF	OFF	OFF	ON	OFF	ON	OFF	Адрес 10
OFF	OFF	OFF	OFF	ON	OFF	ON	ON	Адрес 11
OFF	OFF	OFF	OFF	ON	ON	OFF	OFF	Адрес 12
OFF	OFF	OFF	OFF	ON	ON	OFF	ON	Адрес 13
OFF	OFF	OFF	OFF	ON	ON	ON	OFF	Адрес 14
OFF	OFF	OFF	OFF	ON	ON	ON	ON	Адрес 15
OFF	OFF	OFF	ON	OFF	OFF	OFF	OFF	Адрес 16
OFF	OFF	OFF	ON	OFF	OFF	OFF	ON	Адрес 17
OFF	OFF	OFF	ON	OFF	OFF	ON	OFF	Адрес 18
OFF	OFF	OFF	ON	OFF	OFF	ON	ON	Адрес 19
OFF	OFF	OFF	ON	OFF	ON	OFF	OFF	Адрес 20
OFF	OFF	OFF	ON	OFF	ON	OFF	ON	Адрес 21
OFF	OFF	OFF	ON	OFF	ON	ON	OFF	Адрес 22
OFF	OFF	OFF	ON	OFF	ON	ON	ON	Адрес 23
OFF	OFF	OFF	ON	ON	OFF	OFF	OFF	Адрес 24
OFF	OFF	OFF	ON	ON	OFF	OFF	ON	Адрес 25
OFF	OFF	OFF	ON	ON	OFF	ON	OFF	Адрес 26
OFF	OFF	OFF	ON	ON	OFF	ON	ON	Адрес 27
OFF	OFF	OFF	ON	ON	ON	OFF	OFF	Адрес 28
OFF	OFF	OFF	ON	ON	ON	OFF	ON	Адрес 29
OFF	OFF	OFF	ON	ON	ON	ON	OFF	Адрес 30
OFF	OFF	OFF	ON	ON	ON	ON	ON	Адрес 31
OFF	OFF	ON	OFF	OFF	OFF	OFF	OFF	Адрес 32
OFF	OFF	ON	OFF	OFF	OFF	OFF	ON	Адрес 33
OFF	OFF	ON	OFF	OFF	OFF	ON	OFF	Адрес 34
OFF	OFF	ON	OFF	OFF	OFF	ON	ON	Адрес 35
OFF	OFF	ON	OFF	OFF	ON	OFF	OFF	Адрес 36
OFF	OFF	ON	OFF	OFF	ON	OFF	ON	Адрес 37
OFF	OFF	ON	OFF	OFF	ON	ON	OFF	Адрес 38

УСТАНОВКА АДРЕСА (DIP 3)

SW 8	SW 7	SW 6	SW 5	SW 4	SW 3	SW 2	SW 1	Адрес
OFF	OFF	ON	OFF	OFF	ON	ON	ON	Адрес 39
OFF	OFF	ON	OFF	ON	OFF	OFF	OFF	Адрес 40
OFF	OFF	ON	OFF	ON	OFF	OFF	ON	Адрес 41
OFF	OFF	ON	OFF	ON	OFF	ON	OFF	Адрес 42
OFF	OFF	ON	OFF	ON	OFF	ON	ON	Адрес 43
OFF	OFF	ON	OFF	ON	ON	OFF	OFF	Адрес 44
OFF	OFF	ON	OFF	ON	ON	OFF	ON	Адрес 45
OFF	OFF	ON	OFF	ON	ON	ON	OFF	Адрес 46
OFF	OFF	ON	OFF	ON	ON	ON	ON	Адрес 47
OFF	OFF	ON	ON	OFF	OFF	OFF	OFF	Адрес 48
OFF	OFF	ON	ON	OFF	OFF	OFF	ON	Адрес 49
OFF	OFF	ON	ON	OFF	OFF	ON	OFF	Адрес 50
OFF	OFF	ON	ON	OFF	OFF	ON	ON	Адрес 51
OFF	OFF	ON	ON	OFF	ON	OFF	OFF	Адрес 52
OFF	OFF	ON	ON	OFF	ON	OFF	ON	Адрес 53
OFF	OFF	ON	ON	OFF	ON	ON	OFF	Адрес 54
OFF	OFF	ON	ON	OFF	ON	ON	ON	Адрес 55
OFF	OFF	ON	ON	ON	OFF	OFF	OFF	Адрес 56
OFF	OFF	ON	ON	ON	OFF	OFF	ON	Адрес 57
OFF	OFF	ON	ON	ON	OFF	ON	OFF	Адрес 58
OFF	OFF	ON	ON	ON	OFF	ON	ON	Адрес 59
OFF	OFF	ON	ON	ON	ON	OFF	OFF	Адрес 60
OFF	OFF	ON	ON	ON	ON	OFF	ON	Адрес 61
OFF	OFF	ON	ON	ON	ON	ON	OFF	Адрес 62
OFF	OFF	ON	ON	ON	ON	ON	ON	Адрес 63
OFF	ON	OFF	OFF	OFF	OFF	OFF	OFF	Адрес 64
OFF	ON	OFF	OFF	OFF	OFF	OFF	ON	Адрес 65
OFF	ON	OFF	OFF	OFF	OFF	ON	OFF	Адрес 66
OFF	ON	OFF	OFF	OFF	OFF	ON	ON	Адрес 67
OFF	ON	OFF	OFF	OFF	ON	OFF	OFF	Адрес 68
OFF	ON	OFF	OFF	OFF	ON	OFF	ON	Адрес 69
OFF	ON	OFF	OFF	OFF	ON	ON	OFF	Адрес 70
OFF	ON	OFF	OFF	OFF	ON	ON	ON	Адрес 71
OFF	ON	OFF	OFF	ON	OFF	OFF	OFF	Адрес 72
OFF	ON	OFF	OFF	ON	OFF	OFF	ON	Адрес 73
OFF	ON	OFF	OFF	ON	OFF	ON	OFF	Адрес 74
OFF	ON	OFF	OFF	ON	OFF	ON	ON	Адрес 75
OFF	ON	OFF	OFF	ON	ON	OFF	OFF	Адрес 76
OFF	ON	OFF	OFF	ON	ON	OFF	ON	Адрес 77
OFF	ON	OFF	OFF	ON	ON	ON	OFF	Адрес 78
OFF	ON	OFF	OFF	ON	ON	ON	ON	Адрес 79
OFF	ON	OFF	ON	OFF	OFF	OFF	OFF	Адрес 80
OFF	ON	OFF	ON	OFF	OFF	OFF	ON	Адрес 81
OFF	ON	OFF	ON	OFF	OFF	ON	OFF	Адрес 82

УСТАНОВКА АДРЕСА (DIP 3)								
SW 8	SW 7	SW 6	SW 5	SW 4	SW 3	SW 2	SW 1	Адрес
OFF	ON	OFF	ON	OFF	OFF	ON	ON	Адрес 83
OFF	ON	OFF	ON	OFF	ON	OFF	OFF	Адрес 84
OFF	ON	OFF	ON	OFF	ON	OFF	ON	Адрес 85
OFF	ON	OFF	ON	OFF	ON	ON	OFF	Адрес 86
OFF	ON	OFF	ON	OFF	ON	ON	ON	Адрес 87
OFF	ON	OFF	ON	ON	OFF	OFF	OFF	Адрес 88
OFF	ON	OFF	ON	ON	OFF	ON	OFF	Адрес 89
OFF	ON	OFF	ON	ON	OFF	ON	OFF	Адрес 90
OFF	ON	OFF	ON	ON	OFF	ON	ON	Адрес 91
OFF	ON	OFF	ON	ON	ON	OFF	OFF	Адрес 92
OFF	ON	OFF	ON	ON	ON	OFF	ON	Адрес 93
OFF	ON	OFF	ON	ON	ON	ON	OFF	Адрес 94
OFF	ON	OFF	ON	ON	ON	ON	ON	Адрес 95
OFF	ON	ON	OFF	OFF	OFF	OFF	OFF	Адрес 96
OFF	ON	ON	OFF	OFF	OFF	OFF	ON	Адрес 97
OFF	ON	ON	OFF	OFF	OFF	ON	OFF	Адрес 98
OFF	ON	ON	OFF	OFF	OFF	ON	ON	Адрес 99
OFF	ON	ON	OFF	OFF	ON	OFF	OFF	Адрес 100
OFF	ON	ON	OFF	OFF	ON	OFF	ON	Адрес 101
OFF	ON	ON	OFF	OFF	ON	ON	OFF	Адрес 102
OFF	ON	ON	OFF	OFF	ON	ON	ON	Адрес 103
OFF	ON	ON	OFF	ON	OFF	OFF	OFF	Адрес 104
OFF	ON	ON	OFF	ON	OFF	OFF	ON	Адрес 105
OFF	ON	ON	OFF	ON	OFF	ON	OFF	Адрес 106
OFF	ON	ON	OFF	ON	OFF	ON	ON	Адрес 107
OFF	ON	ON	OFF	ON	ON	OFF	OFF	Адрес 108
OFF	ON	ON	OFF	ON	ON	OFF	ON	Адрес 109
OFF	ON	ON	OFF	ON	ON	ON	OFF	Адрес 110
OFF	ON	ON	OFF	ON	ON	ON	ON	Адрес 111
OFF	ON	ON	ON	OFF	OFF	OFF	OFF	Адрес 112
OFF	ON	ON	ON	OFF	OFF	OFF	ON	Адрес 113
OFF	ON	ON	ON	OFF	OFF	ON	OFF	Адрес 114
OFF	ON	ON	ON	OFF	OFF	ON	ON	Адрес 115
OFF	ON	ON	ON	OFF	ON	OFF	OFF	Адрес 116
OFF	ON	ON	ON	OFF	ON	OFF	ON	Адрес 117
OFF	ON	ON	ON	OFF	ON	ON	OFF	Адрес 118
OFF	ON	ON	ON	OFF	ON	ON	ON	Адрес 119
OFF	ON	ON	ON	ON	OFF	OFF	OFF	Адрес 120
OFF	ON	ON	ON	ON	OFF	OFF	ON	Адрес 121
OFF	ON	ON	ON	ON	OFF	ON	OFF	Адрес 122
OFF	ON	ON	ON	ON	OFF	ON	ON	Адрес 123
OFF	ON	ON	ON	ON	ON	OFF	OFF	Адрес 124
OFF	ON	ON	ON	ON	ON	OFF	ON	Адрес 125
OFF	ON	ON	ON	ON	ON	ON	OFF	Адрес 126

УСТАНОВКА АДРЕСА (DIP 3)

SW 8	SW 7	SW 6	SW 5	SW 4	SW 3	SW 2	SW 1	Адрес
OFF	ON	ON	ON	ON	ON	ON	ON	Адрес 127
ON	OFF	OFF	OFF	OFF	OFF	OFF	OFF	Адрес 128
ON	OFF	OFF	OFF	OFF	OFF	OFF	ON	Адрес 129
ON	OFF	OFF	OFF	OFF	OFF	ON	OFF	Адрес 130
ON	OFF	OFF	OFF	OFF	OFF	ON	ON	Адрес 131
ON	OFF	OFF	OFF	OFF	ON	OFF	OFF	Адрес 132
ON	OFF	OFF	OFF	OFF	ON	OFF	ON	Адрес 133
ON	OFF	OFF	OFF	OFF	ON	ON	OFF	Адрес 134
ON	OFF	OFF	OFF	OFF	ON	ON	ON	Адрес 135
ON	OFF	OFF	OFF	ON	OFF	OFF	OFF	Адрес 136
ON	OFF	OFF	OFF	ON	OFF	OFF	ON	Адрес 137
ON	OFF	OFF	OFF	ON	OFF	ON	OFF	Адрес 138
ON	OFF	OFF	OFF	ON	OFF	ON	ON	Адрес 139
ON	OFF	OFF	OFF	ON	ON	OFF	OFF	Адрес 140
ON	OFF	OFF	OFF	ON	ON	OFF	ON	Адрес 141
ON	OFF	OFF	OFF	ON	ON	ON	OFF	Адрес 142
ON	OFF	OFF	OFF	ON	ON	ON	ON	Адрес 143
ON	OFF	OFF	ON	OFF	OFF	OFF	OFF	Адрес 144
ON	OFF	OFF	ON	OFF	OFF	OFF	ON	Адрес 145
ON	OFF	OFF	ON	OFF	OFF	ON	OFF	Адрес 146
ON	OFF	OFF	ON	OFF	OFF	ON	ON	Адрес 147
ON	OFF	OFF	ON	OFF	ON	OFF	OFF	Адрес 148
ON	OFF	OFF	ON	OFF	ON	OFF	ON	Адрес 149
ON	OFF	OFF	ON	OFF	ON	ON	OFF	Адрес 150
ON	OFF	OFF	ON	OFF	ON	ON	ON	Адрес 151
ON	OFF	OFF	ON	ON	OFF	OFF	OFF	Адрес 152
ON	OFF	OFF	ON	ON	OFF	OFF	ON	Адрес 153
ON	OFF	OFF	ON	ON	OFF	ON	OFF	Адрес 154
ON	OFF	OFF	ON	ON	OFF	ON	ON	Адрес 155
ON	OFF	OFF	ON	ON	ON	OFF	OFF	Адрес 156
ON	OFF	OFF	ON	ON	ON	OFF	ON	Адрес 157
ON	OFF	OFF	ON	ON	ON	ON	OFF	Адрес 158
ON	OFF	OFF	ON	ON	ON	ON	ON	Адрес 159
ON	OFF	ON	OFF	OFF	OFF	OFF	OFF	Адрес 160
ON	OFF	ON	OFF	OFF	OFF	OFF	ON	Адрес 161
ON	OFF	ON	OFF	OFF	OFF	ON	OFF	Адрес 162
ON	OFF	ON	OFF	OFF	OFF	ON	ON	Адрес 163
ON	OFF	ON	OFF	OFF	ON	OFF	OFF	Адрес 164
ON	OFF	ON	OFF	OFF	ON	OFF	ON	Адрес 165
ON	OFF	ON	OFF	OFF	ON	ON	OFF	Адрес 166
ON	OFF	ON	OFF	OFF	ON	ON	ON	Адрес 167
ON	OFF	ON	OFF	ON	OFF	OFF	OFF	Адрес 168
ON	OFF	ON	OFF	ON	OFF	OFF	ON	Адрес 169
ON	OFF	ON	OFF	ON	OFF	ON	OFF	Адрес 170

УСТАНОВКА АДРЕСА (DIP 3)

SW 8	SW 7	SW 6	SW 5	SW 4	SW 3	SW 2	SW 1	Адрес
ON	OFF	ON	OFF	ON	OFF	ON	ON	Адрес 171
ON	OFF	ON	OFF	ON	ON	OFF	OFF	Адрес 172
ON	OFF	ON	OFF	ON	ON	OFF	ON	Адрес 173
ON	OFF	ON	OFF	ON	ON	ON	OFF	Адрес 174
ON	OFF	ON	OFF	ON	ON	ON	ON	Адрес 175
ON	OFF	ON	ON	OFF	OFF	OFF	OFF	Адрес 176
ON	OFF	ON	ON	OFF	OFF	OFF	ON	Адрес 177
ON	OFF	ON	ON	OFF	OFF	ON	OFF	Адрес 178
ON	OFF	ON	ON	OFF	OFF	ON	ON	Адрес 179
ON	OFF	ON	ON	OFF	ON	OFF	OFF	Адрес 180
ON	OFF	ON	ON	OFF	ON	OFF	ON	Адрес 181
ON	OFF	ON	ON	OFF	ON	ON	OFF	Адрес 182
ON	OFF	ON	ON	OFF	ON	ON	ON	Адрес 183
ON	OFF	ON	ON	ON	OFF	OFF	OFF	Адрес 184
ON	OFF	ON	ON	ON	OFF	OFF	ON	Адрес 185
ON	OFF	ON	ON	ON	OFF	ON	OFF	Адрес 186
ON	OFF	ON	ON	ON	OFF	ON	ON	Адрес 187
ON	OFF	ON	ON	ON	ON	OFF	OFF	Адрес 188
ON	OFF	ON	ON	ON	ON	OFF	ON	Адрес 189
ON	OFF	ON	ON	ON	ON	ON	OFF	Адрес 190
ON	OFF	ON	ON	ON	ON	ON	ON	Адрес 191
ON	ON	OFF	OFF	OFF	OFF	OFF	OFF	Адрес 192
ON	ON	OFF	OFF	OFF	OFF	OFF	ON	Адрес 193
ON	ON	OFF	OFF	OFF	OFF	ON	OFF	Адрес 194
ON	ON	OFF	OFF	OFF	OFF	ON	ON	Адрес 195
ON	ON	OFF	OFF	OFF	ON	OFF	OFF	Адрес 196
ON	ON	OFF	OFF	OFF	ON	OFF	ON	Адрес 197
ON	ON	OFF	OFF	OFF	ON	ON	OFF	Адрес 198
ON	ON	OFF	OFF	OFF	ON	ON	ON	Адрес 199
ON	ON	OFF	OFF	ON	OFF	OFF	OFF	Адрес 200
ON	ON	OFF	OFF	ON	OFF	OFF	ON	Адрес 201
ON	ON	OFF	OFF	ON	OFF	ON	OFF	Адрес 202
ON	ON	OFF	OFF	ON	OFF	ON	ON	Адрес 203
ON	ON	OFF	OFF	ON	ON	OFF	OFF	Адрес 204
ON	ON	OFF	OFF	ON	ON	OFF	ON	Адрес 205
ON	ON	OFF	OFF	ON	ON	ON	OFF	Адрес 206
ON	ON	OFF	OFF	ON	ON	ON	ON	Адрес 207
ON	ON	OFF	ON	OFF	OFF	OFF	OFF	Адрес 208
ON	ON	OFF	ON	OFF	OFF	OFF	ON	Адрес 209
ON	ON	OFF	ON	OFF	OFF	ON	OFF	Адрес 210
ON	ON	OFF	ON	OFF	OFF	ON	ON	Адрес 211
ON	ON	OFF	ON	OFF	ON	OFF	OFF	Адрес 212
ON	ON	OFF	ON	OFF	ON	OFF	ON	Адрес 213
ON	ON	OFF	ON	OFF	ON	ON	OFF	Адрес 214

УСТАНОВКА АДРЕСА (DIP 3)								
SW 8	SW 7	SW 6	SW 5	SW 4	SW 3	SW 2	SW 1	Адрес
ON	ON	OFF	ON	OFF	ON	ON	ON	Адрес 215
ON	ON	OFF	ON	ON	OFF	OFF	OFF	Адрес 216
ON	ON	OFF	ON	ON	OFF	OFF	ON	Адрес 217
ON	ON	OFF	ON	ON	OFF	ON	OFF	Адрес 218
ON	ON	OFF	ON	ON	OFF	ON	ON	Адрес 219
ON	ON	OFF	ON	ON	ON	OFF	OFF	Адрес 220
ON	ON	OFF	ON	ON	ON	OFF	ON	Адрес 221
ON	ON	OFF	ON	ON	ON	ON	OFF	Адрес 222
ON	ON	OFF	ON	ON	ON	ON	ON	Адрес 223
ON	ON	ON	OFF	OFF	OFF	OFF	OFF	Адрес 224
ON	ON	ON	OFF	OFF	OFF	OFF	ON	Адрес 225
ON	ON	ON	OFF	OFF	OFF	ON	OFF	Адрес 226
ON	ON	ON	OFF	OFF	OFF	ON	ON	Адрес 227
ON	ON	ON	OFF	OFF	ON	OFF	OFF	Адрес 228
ON	ON	ON	OFF	OFF	ON	OFF	ON	Адрес 229
ON	ON	ON	OFF	OFF	ON	ON	OFF	Адрес 230
ON	ON	ON	OFF	OFF	ON	ON	ON	Адрес 231
ON	ON	ON	OFF	ON	OFF	OFF	OFF	Адрес 232
ON	ON	ON	OFF	ON	OFF	OFF	ON	Адрес 233
ON	ON	ON	OFF	ON	OFF	ON	OFF	Адрес 234
ON	ON	ON	OFF	ON	OFF	ON	ON	Адрес 235
ON	ON	ON	OFF	ON	ON	OFF	OFF	Адрес 236
ON	ON	ON	OFF	ON	ON	OFF	ON	Адрес 237
ON	ON	ON	OFF	ON	ON	ON	OFF	Адрес 238
ON	ON	ON	OFF	ON	ON	ON	ON	Адрес 239
ON	ON	ON	ON	OFF	OFF	OFF	OFF	Адрес 240
ON	ON	ON	ON	OFF	OFF	OFF	ON	Адрес 241
ON	ON	ON	ON	OFF	OFF	ON	OFF	Адрес 242
ON	ON	ON	ON	OFF	OFF	ON	ON	Адрес 243
ON	ON	ON	ON	OFF	ON	OFF	OFF	Адрес 244
ON	ON	ON	ON	OFF	ON	OFF	ON	Адрес 245
ON	ON	ON	ON	OFF	ON	ON	OFF	Адрес 246
ON	ON	ON	ON	OFF	ON	ON	ON	Адрес 247
ON	ON	ON	ON	ON	OFF	OFF	OFF	Адрес 248
ON	ON	ON	ON	ON	OFF	OFF	ON	Адрес 249
ON	ON	ON	ON	ON	OFF	ON	OFF	Адрес 250
ON	ON	ON	ON	ON	OFF	ON	ON	Адрес 251
ON	ON	ON	ON	ON	ON	OFF	OFF	Адрес 252
ON	ON	ON	ON	ON	ON	OFF	ON	Адрес 253
ON	ON	ON	ON	ON	ON	ON	OFF	Адрес 254
ON	ON	ON	ON	ON	ON	ON	ON	Адрес 255

Таб. 21

Headquarters Italy Videotec S.p.A.

Via Friuli, 6 - I-36015 Schio (VI) - Italy

Tel. +39 0445 697411 - Fax +39 0445 697414

Email: info@videotec.com

Asia Pacific Videotec (HK) Ltd

Flat 8, 19/F. On Dak Industrial Building, No. 2-6 Wah Sing Street

Kwai Chung, New Territories - Hong Kong

Tel. +852 2333 0601 - Fax +852 2311 0026

Email: info.hk@videotec.com

France Videotec France SARL

Immeuble Le Montreal, 19bis Avenue du Québec, ZA de Courtaboeuf
91140 Villebon sur Yvette - France

Tel. +33 1 60491816 - Fax +33 1 69284736

Email: info.fr@videotec.com

Americas Videotec Security, Inc.

Gateway Industrial Park, 35 Gateway Drive, Suite 100
Plattsburgh, NY 12901 - U.S.A.

Tel. +1 518 825 0020 - Fax +1 518 825 0022

Email: info.usa@videotec.com - www.videotec.com



www.videotec.com

MNVCUPTMAXB_1511_RU

Headquarters Italy Videotec S.p.A.

Via Friuli, 6 - I-36015 Schio (VI) - Italy

Tel. +39 0445 697411 - Fax +39 0445 697414

Email: info@videotec.com

Asia Pacific Videotec (HK) Ltd

Flat 8, 19/F. On Dak Industrial Building, No. 2-6 Wah Sing Street

Kwai Chung, New Territories - Hong Kong

Tel. +852 2333 0601 - Fax +852 2311 0026

Email: info.hk@videotec.com

France Videotec France SARL

Immeuble Le Montreal, 19bis Avenue du Québec, ZA de Courtaboeuf
91140 Villebon sur Yvette - France

Tel. +33 1 60491816 - Fax +33 1 69284736

Email: info.fr@videotec.com

Americas Videotec Security, Inc.

Gateway Industrial Park, 35 Gateway Drive, Suite 100
Plattsburgh, NY 12901 - U.S.A.

Tel. +1 518 825 0020 - Fax +1 518 825 0022

Email: info.usa@videotec.com - www.videotec.com



www.videotec.com

MNVCUPTMAXB_1511